

2016年4月28日
東京電力ホールディングス株式会社

建屋内の空間線量率について

データ採取期間

- ・ 5号機 : 2016年2月1日～2016年2月29日

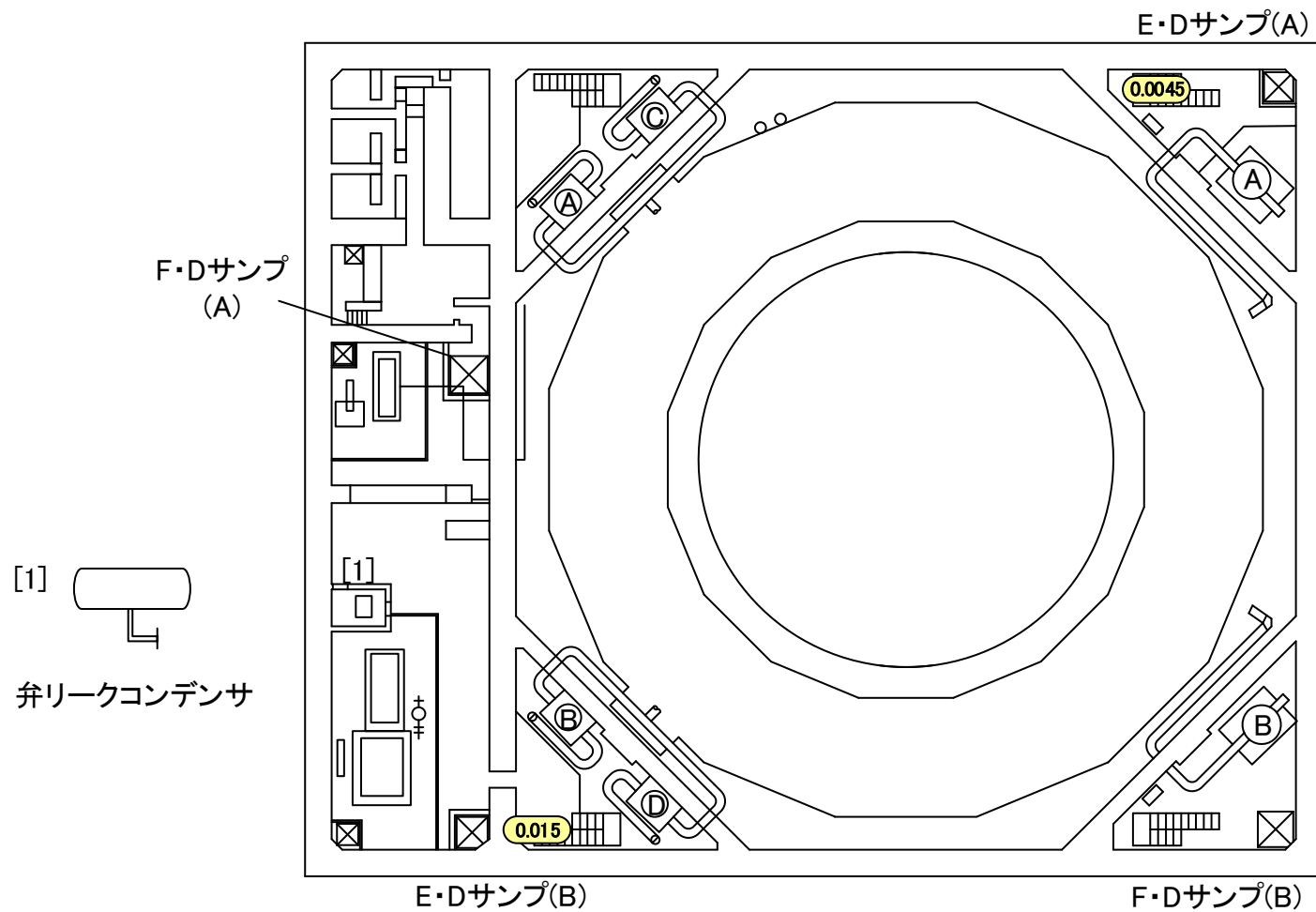

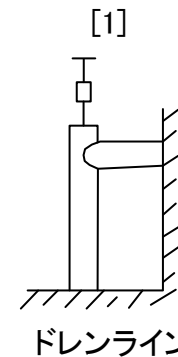
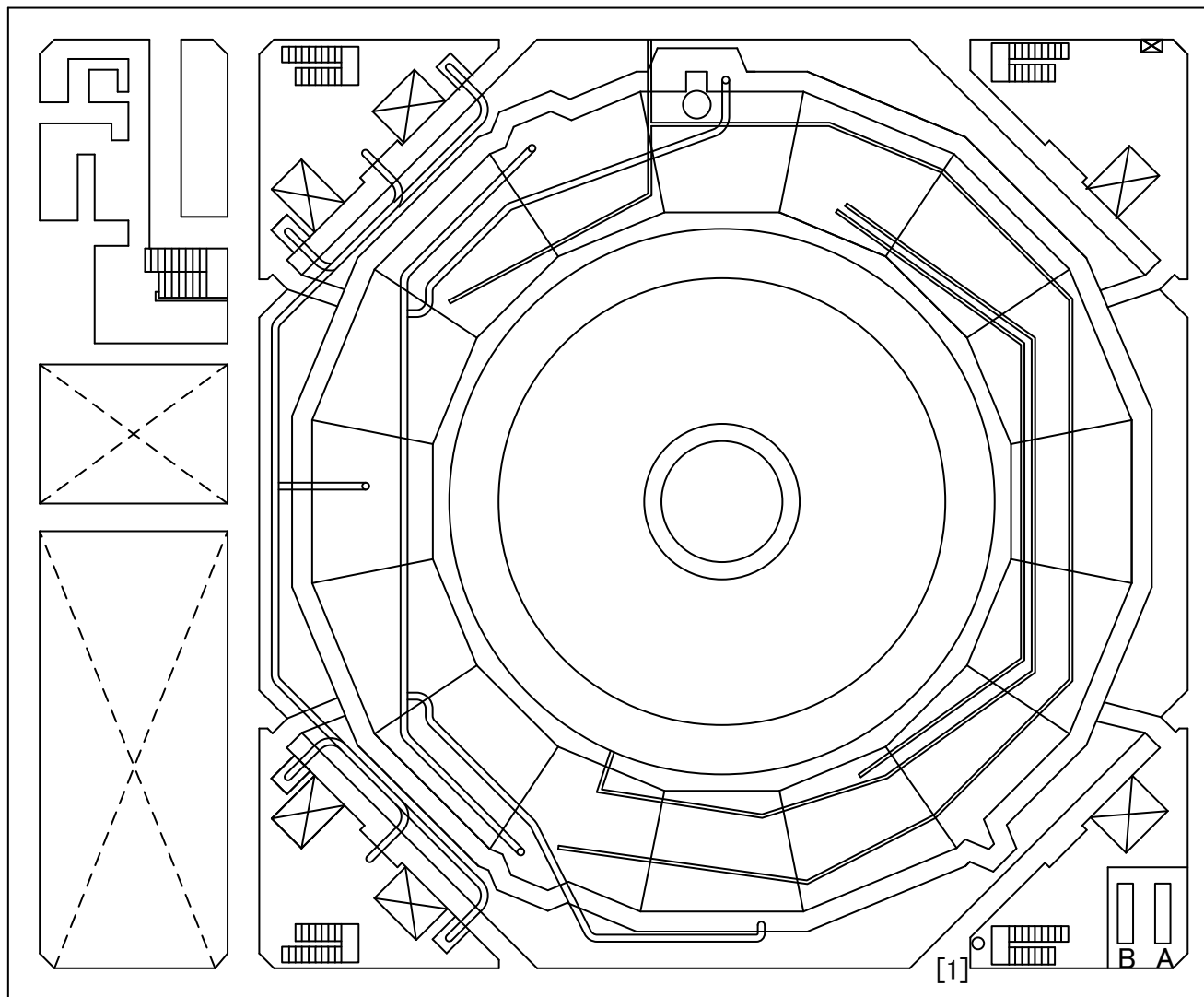

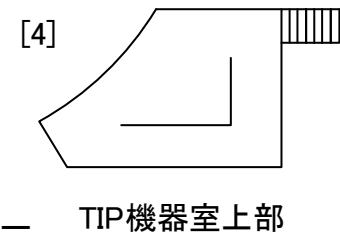
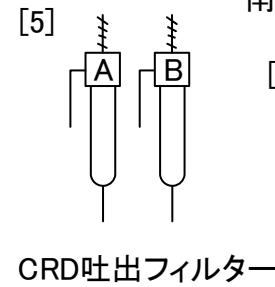
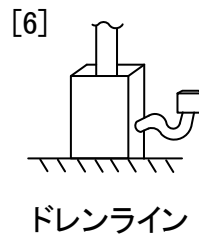
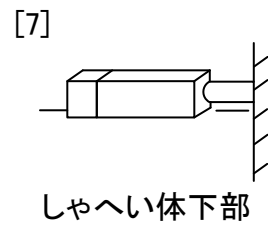
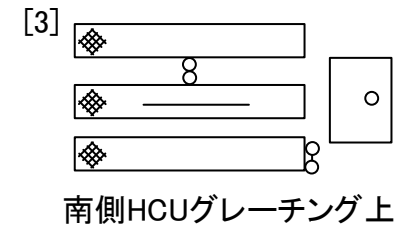
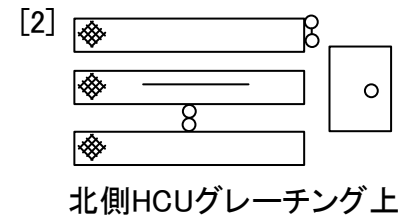
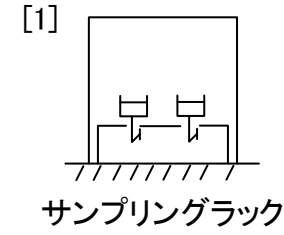
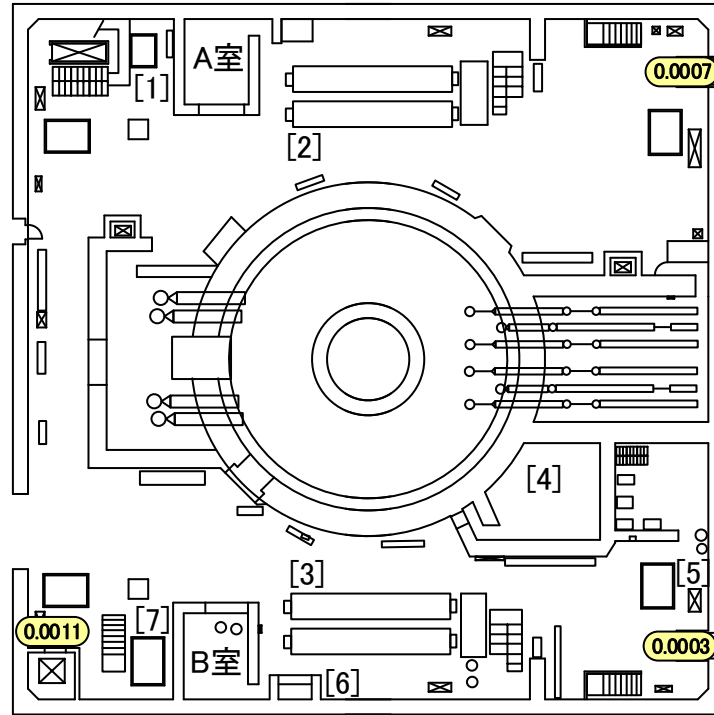

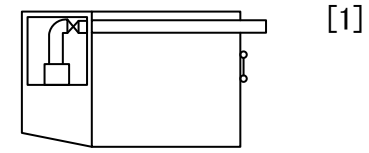
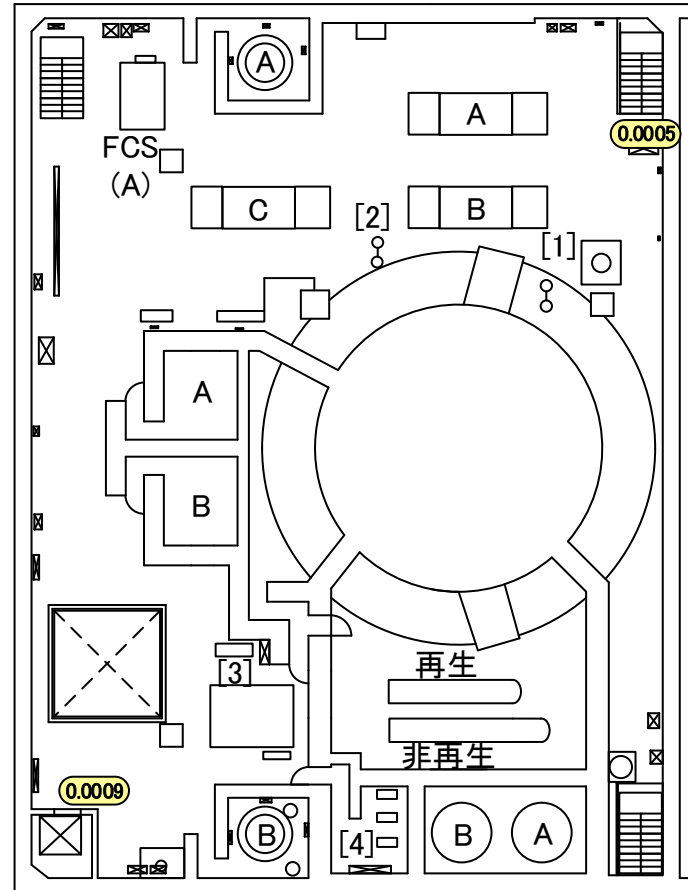

北東側グレーチング上

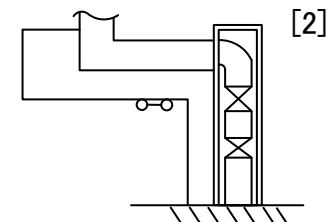

北側グレーチング上

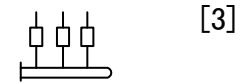

計装ラック下部

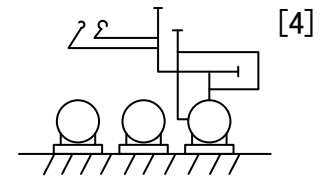

スラッジ放出混合ポンプ

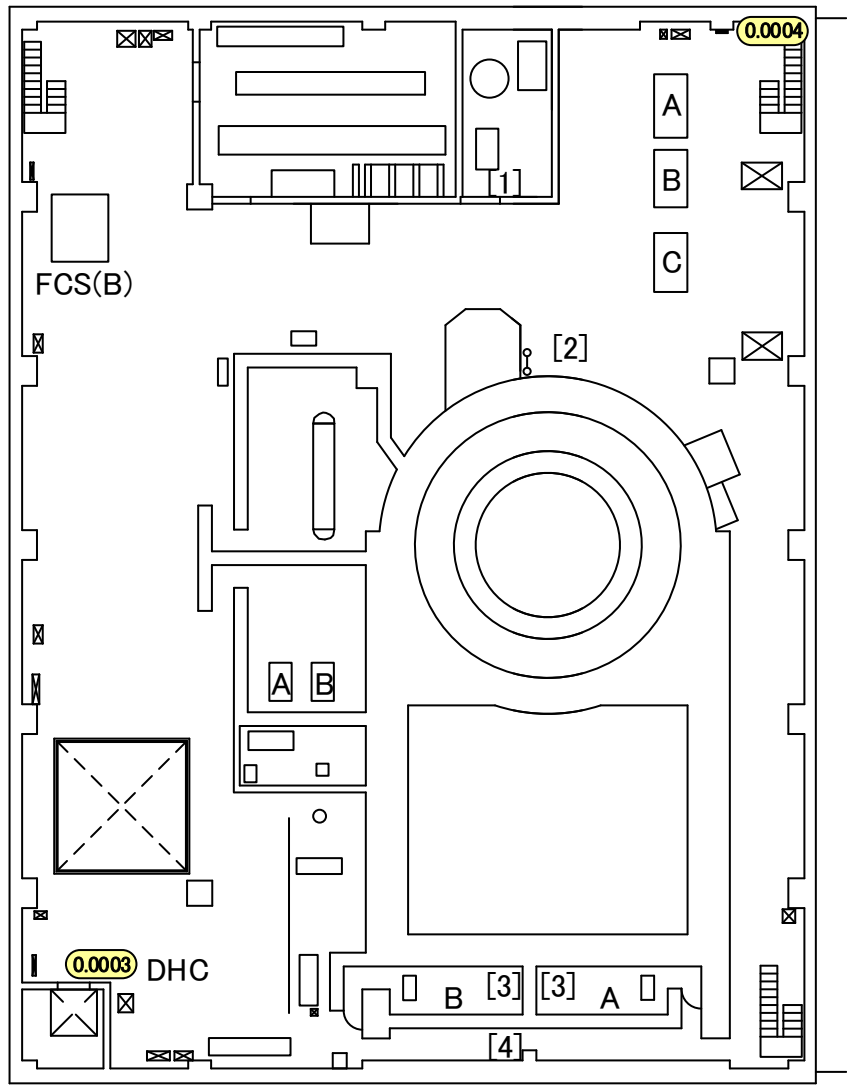
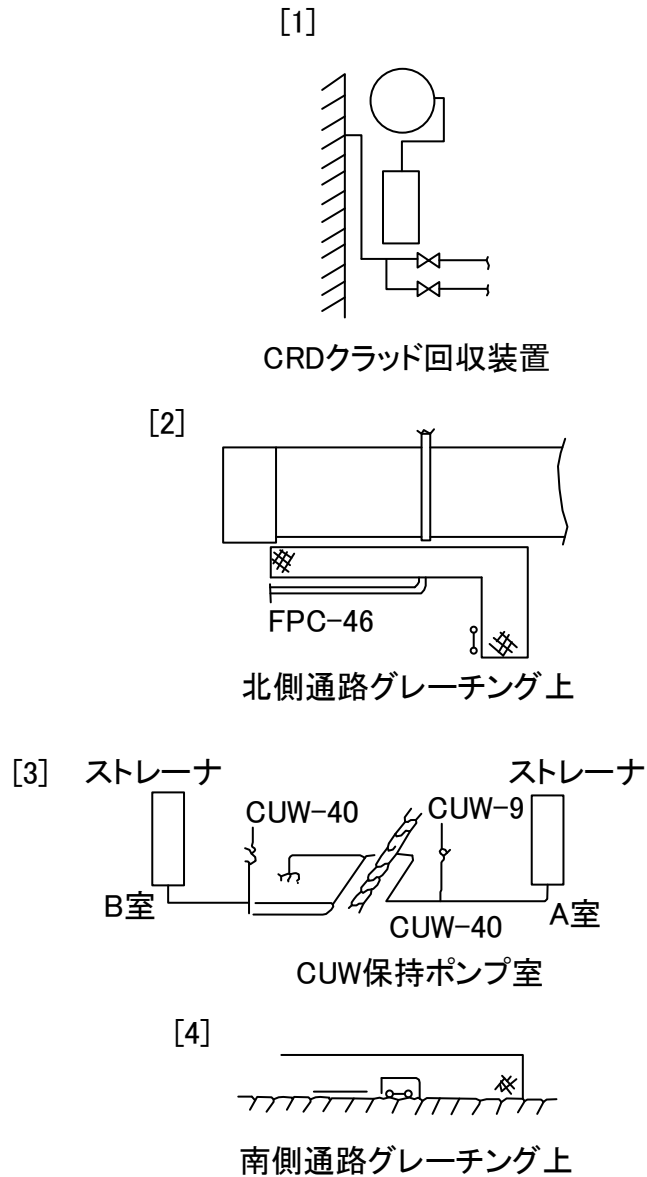

1F05RB004-00-01



0 10000

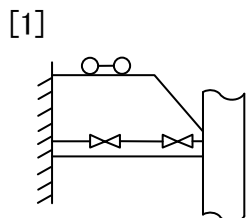

ウェル換気(東側)

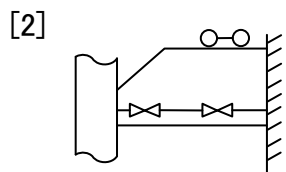

ウェル換気(西側)

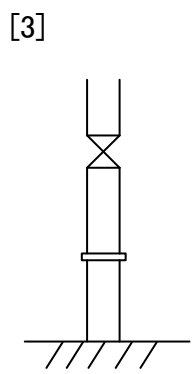

FPC-46

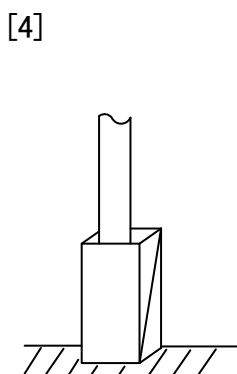

FPC-8

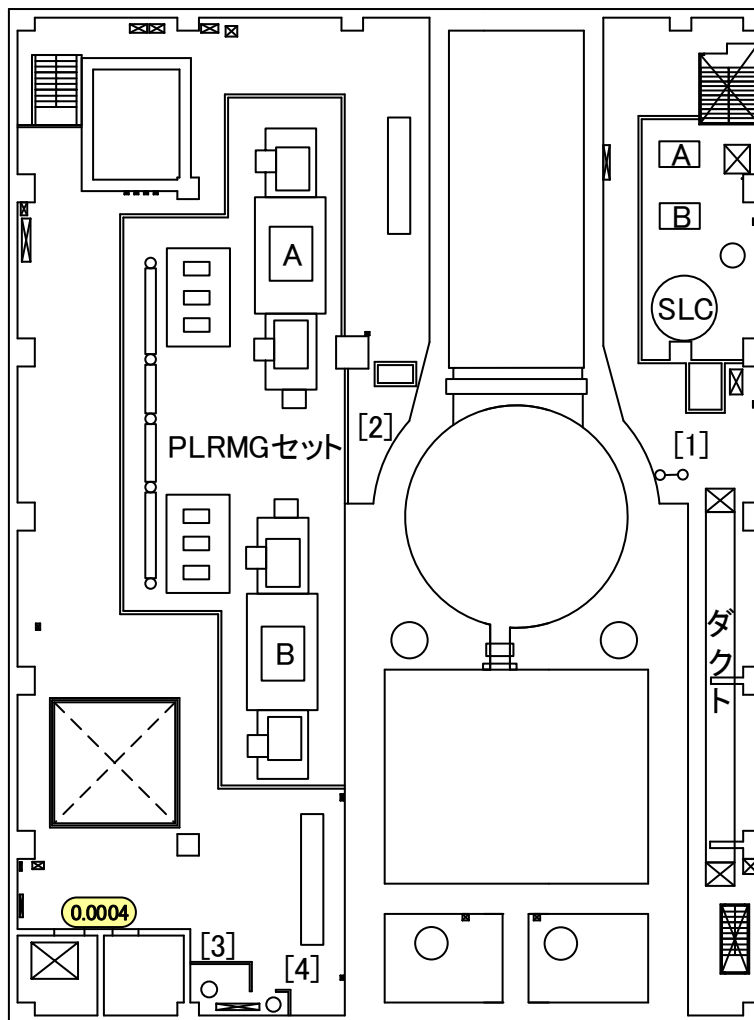

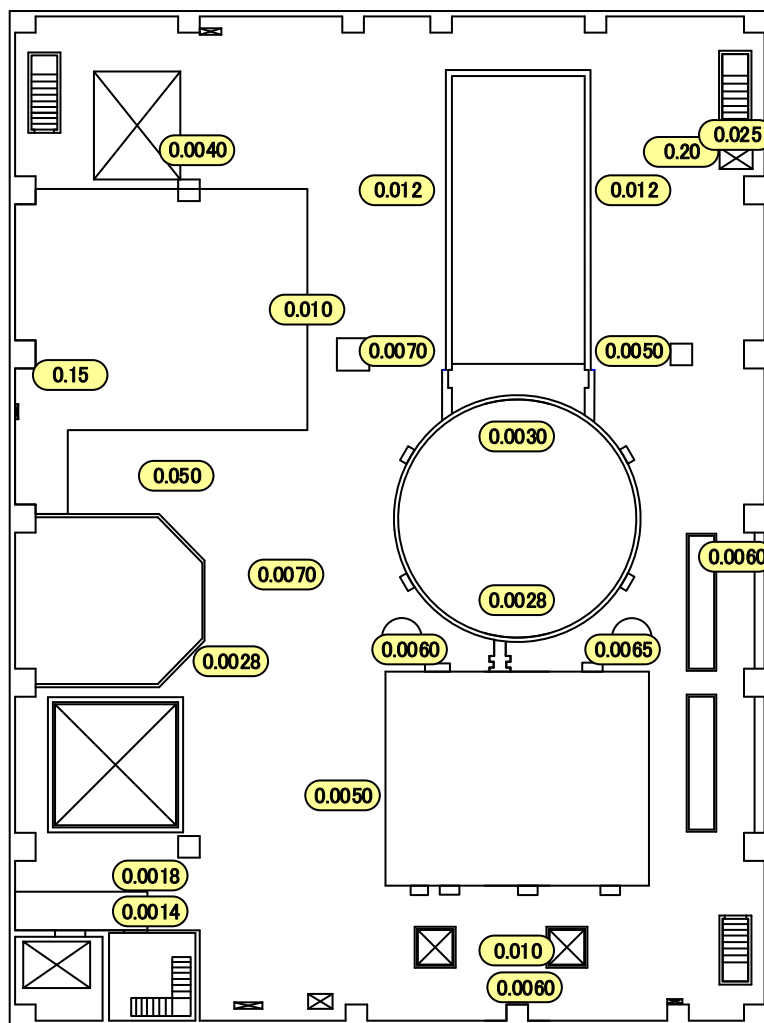

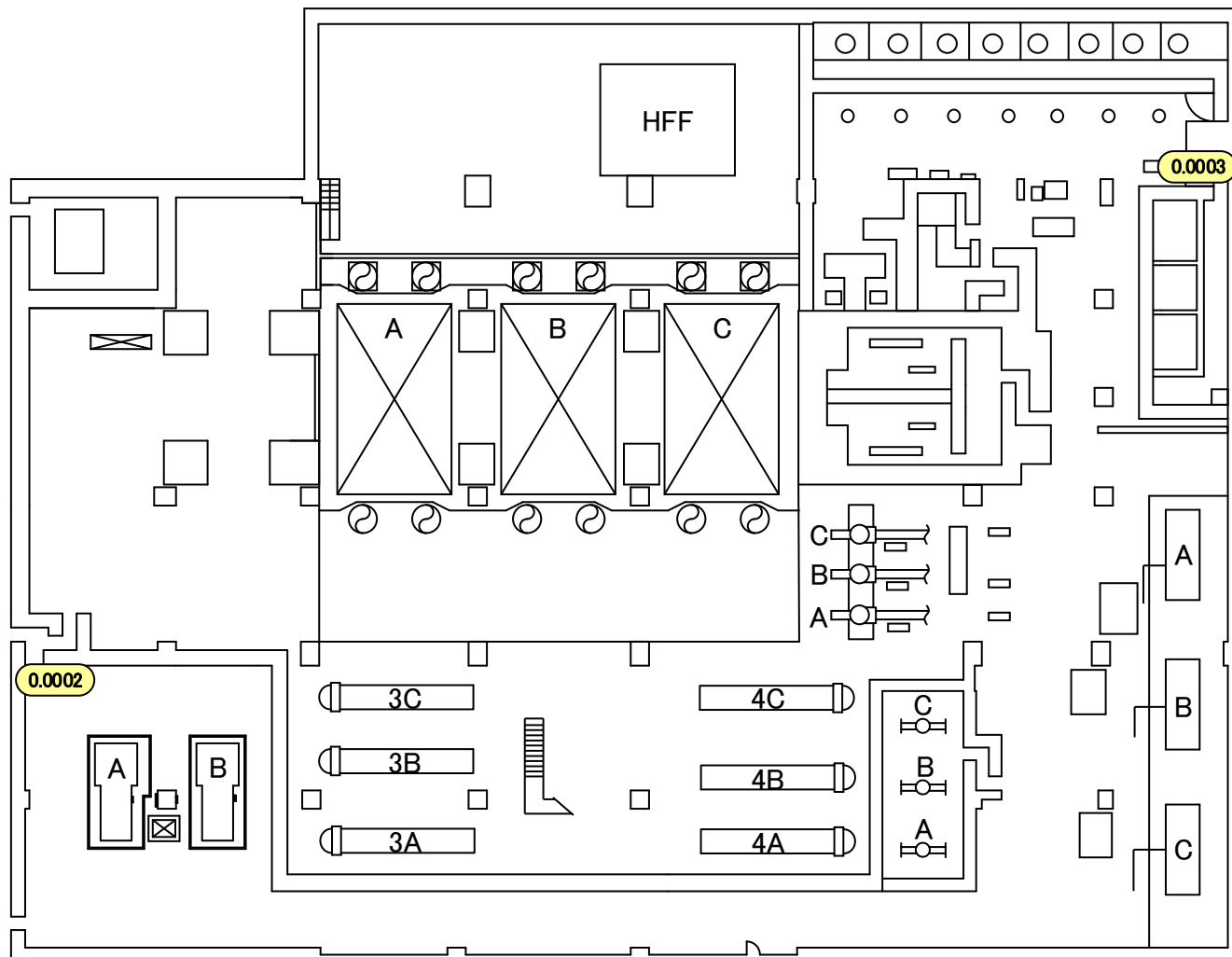

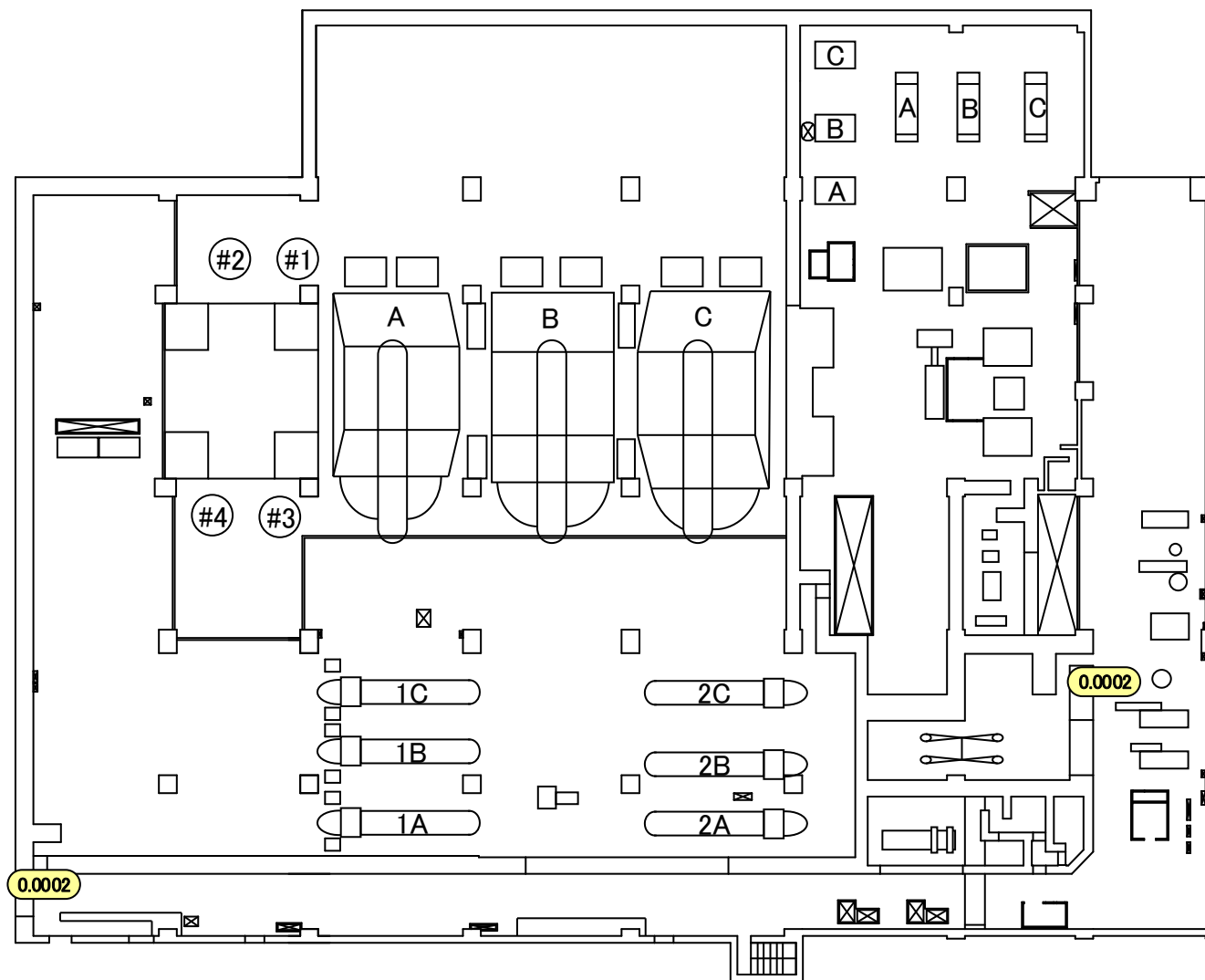

[1]
AS-23

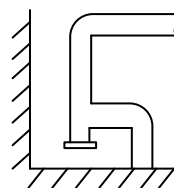

[2]
エバポレータ

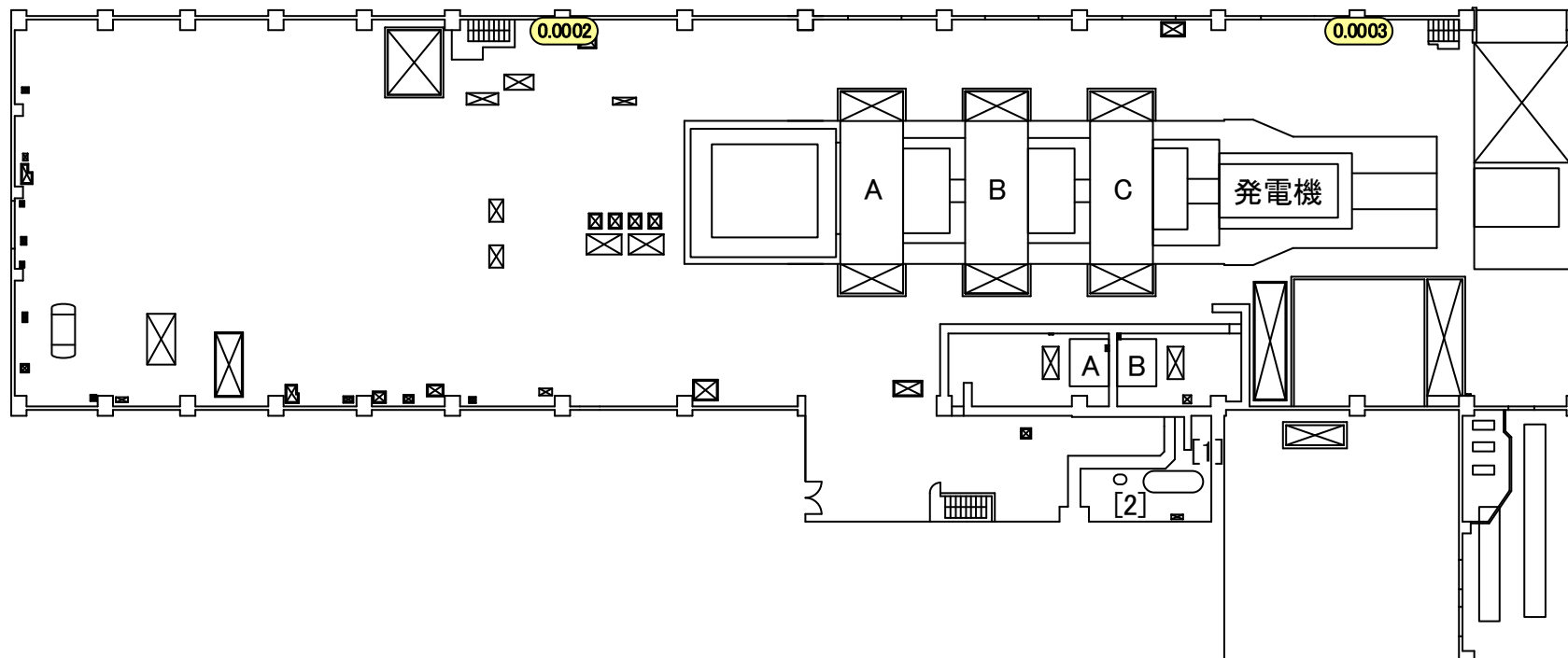
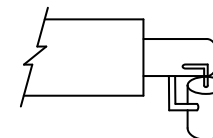

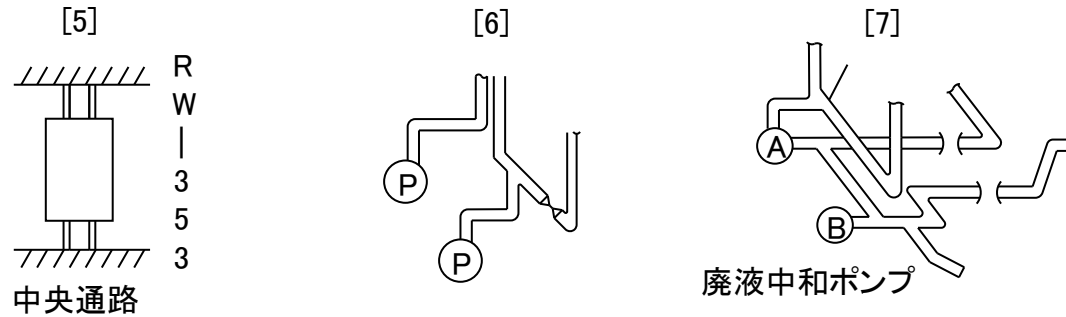
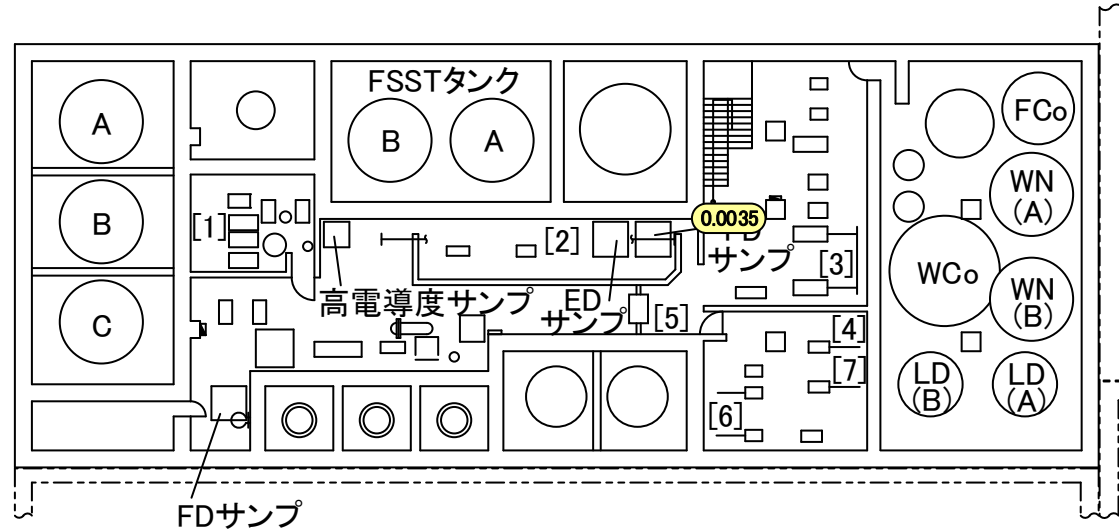
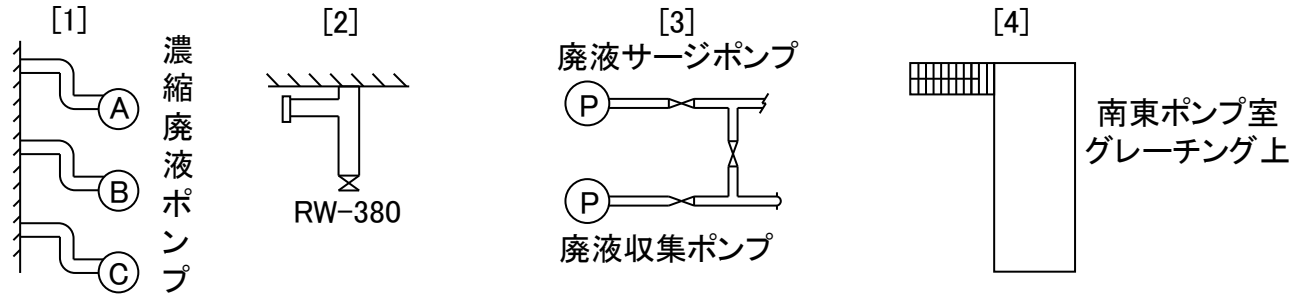

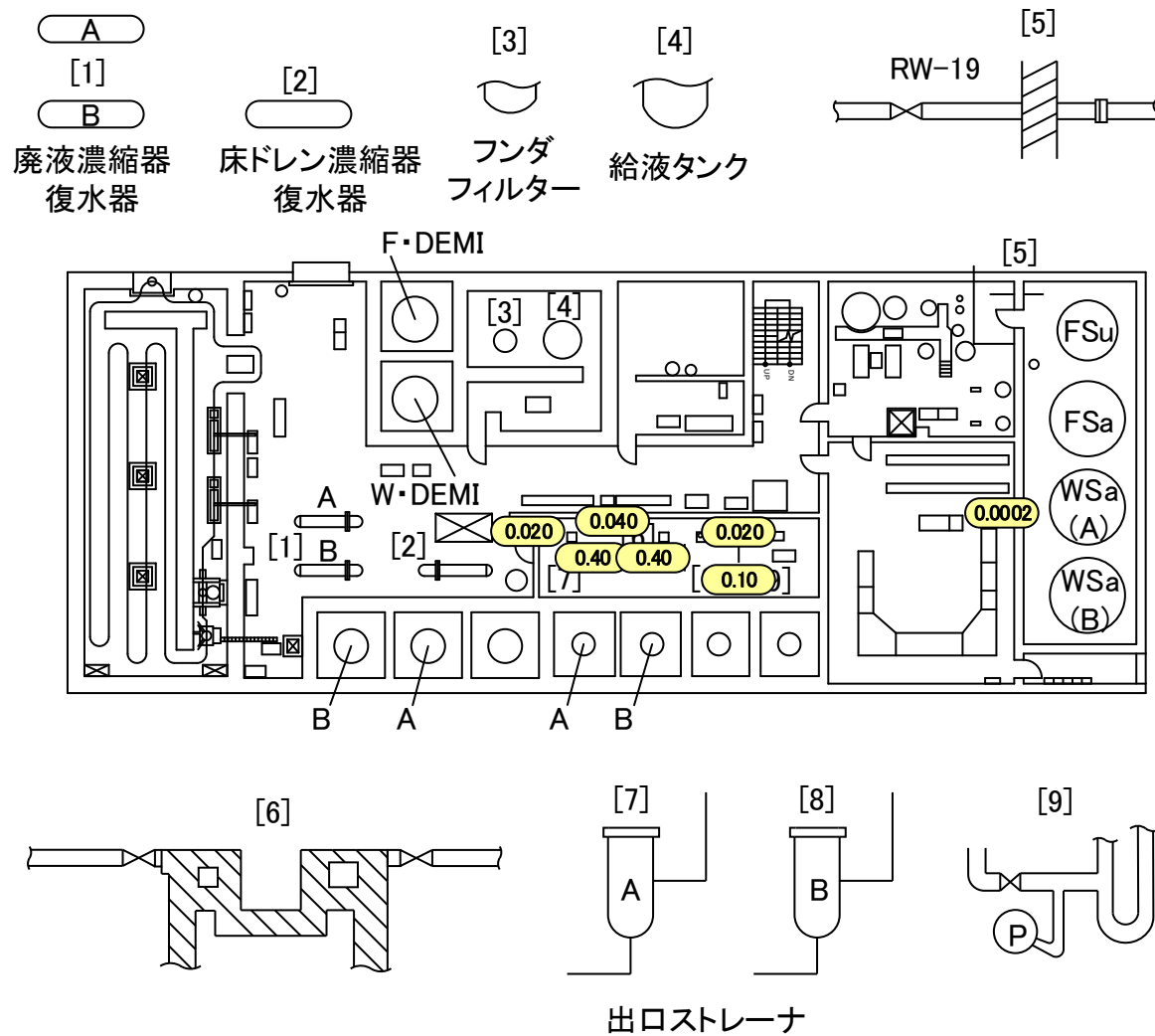

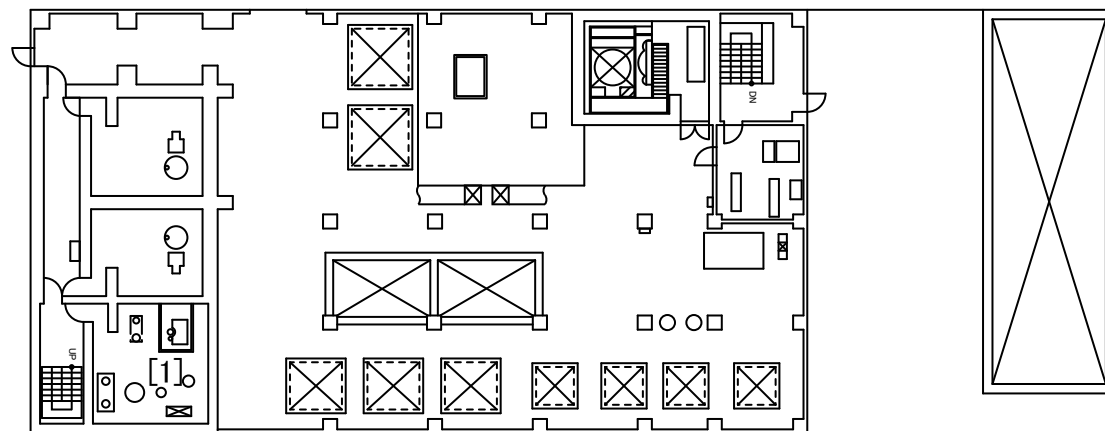

[1]



濃縮廃液計量タンク

福島第一 原子力発電所

図面名称:

5号機 廃棄物処理建屋 3階

[単位: mSv/h]

