

2015年12月28日
東京電力株式会社

建屋内の空間線量率について

データ採取期間

- ・ 5号機 : 2015年10月1日～2015年10月31日

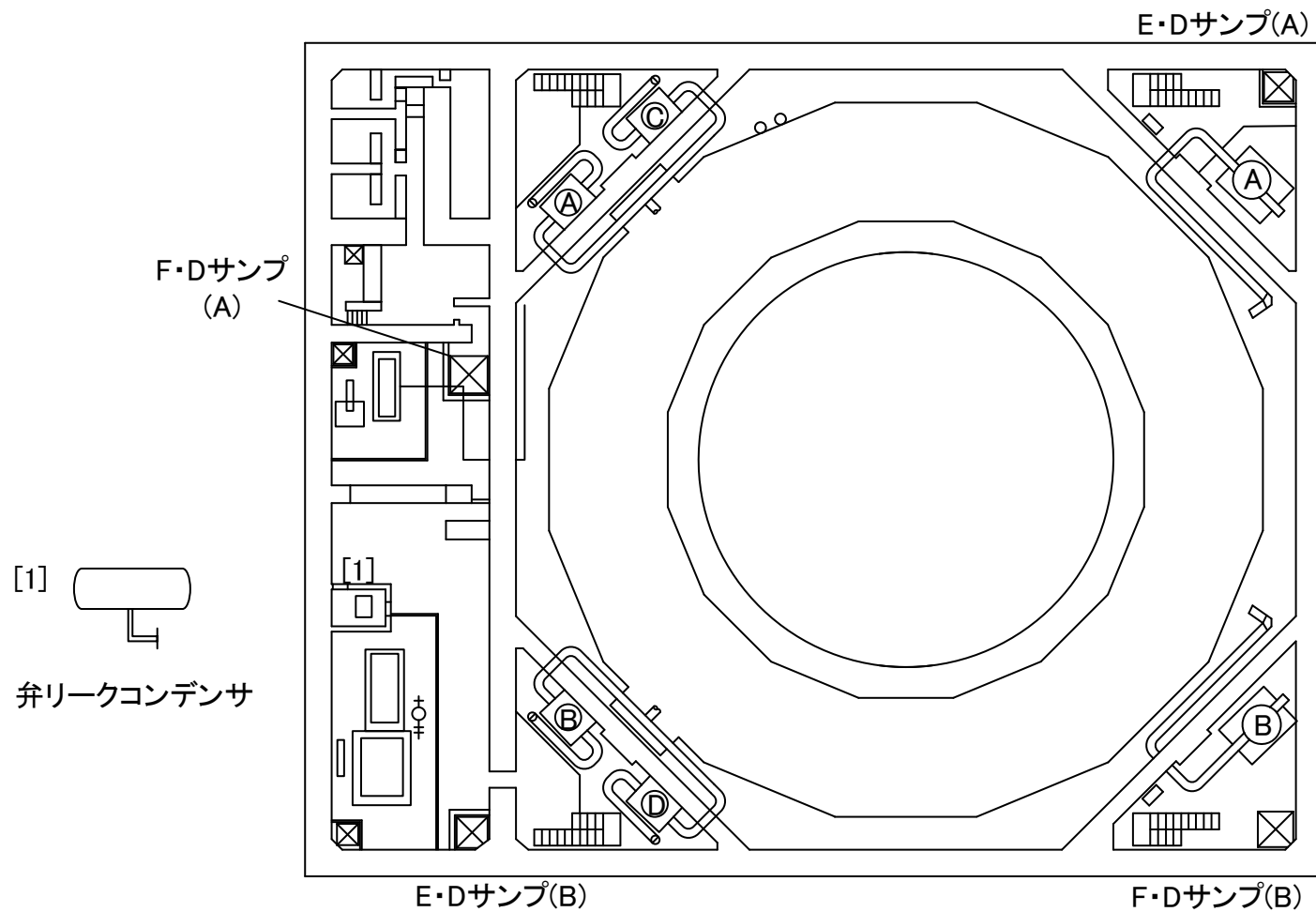

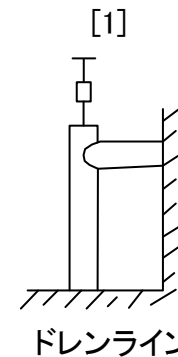
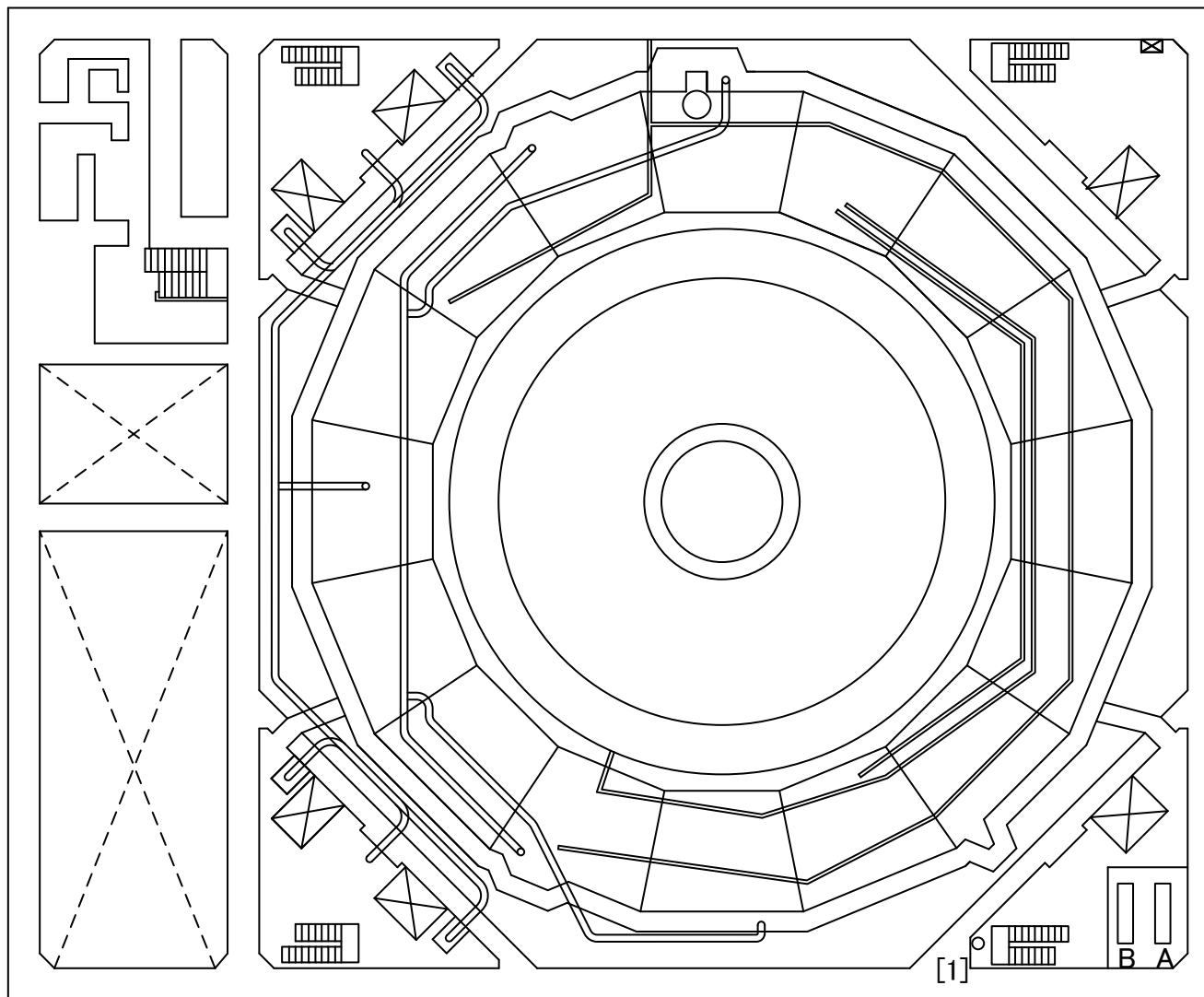

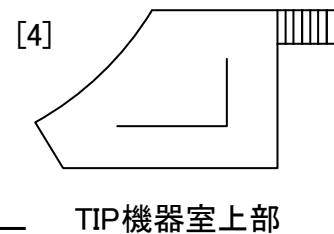
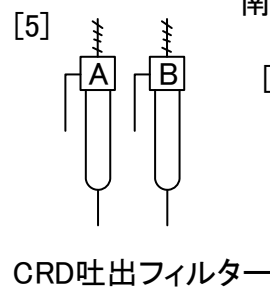
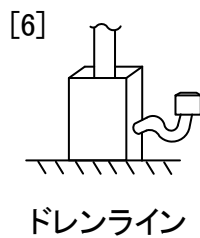
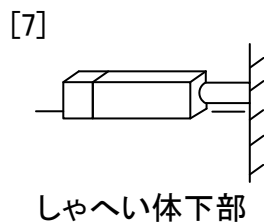
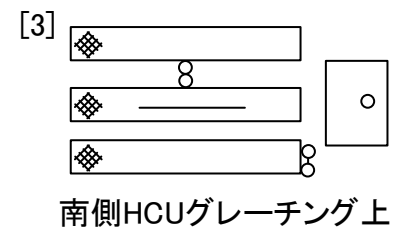
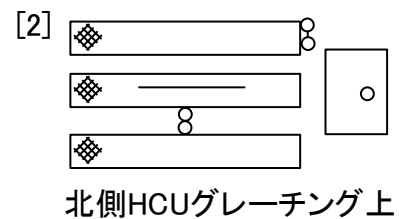
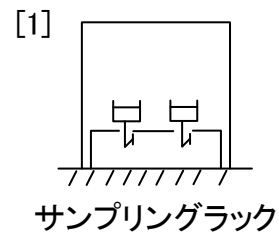
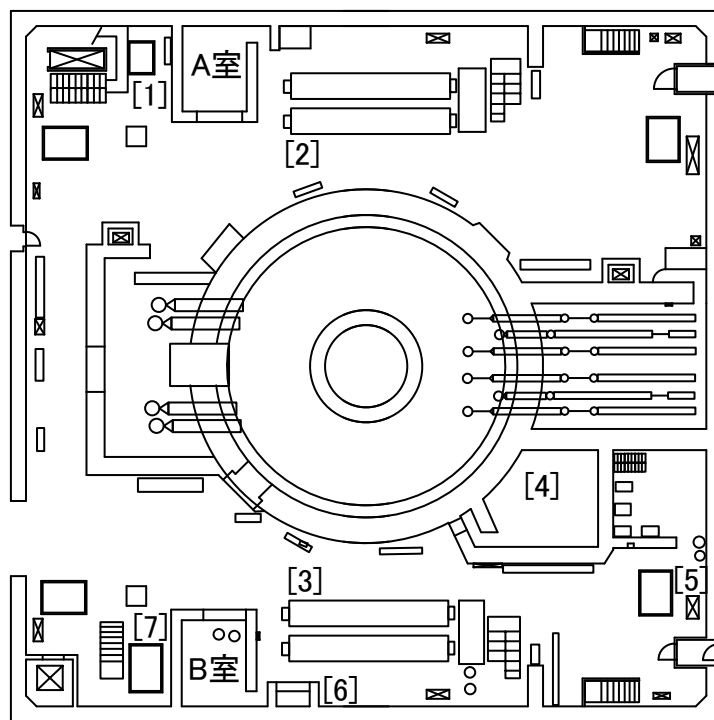

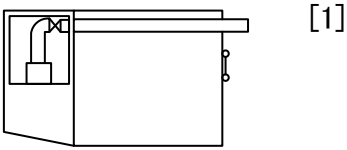
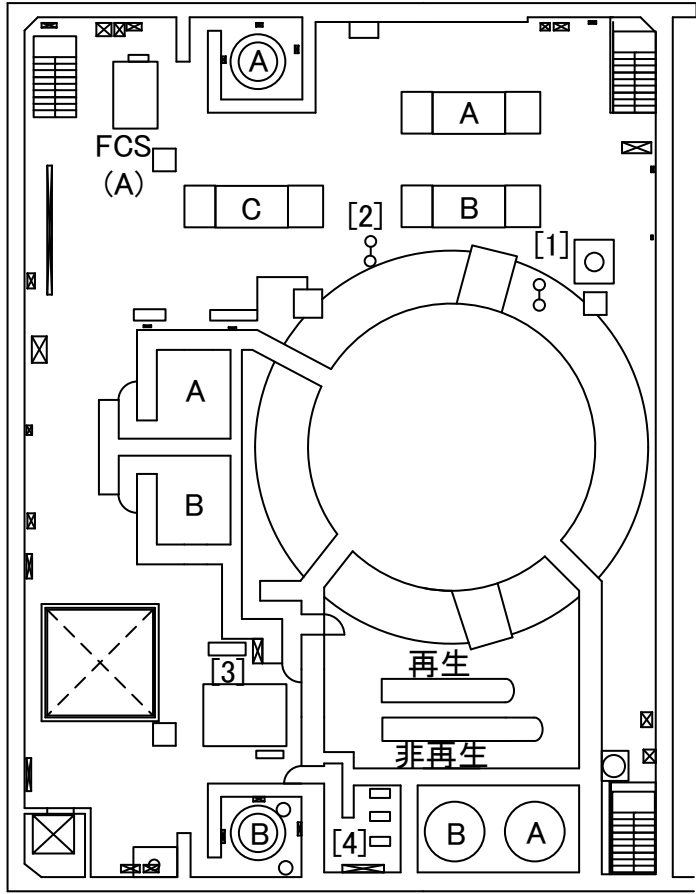

北東側グレーチング上

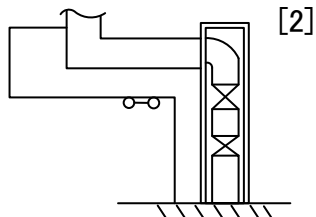

北側グレーチング上

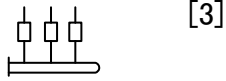

計装ラック下部

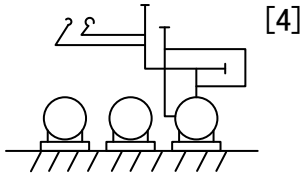

スラッジ放出混合ポンプ

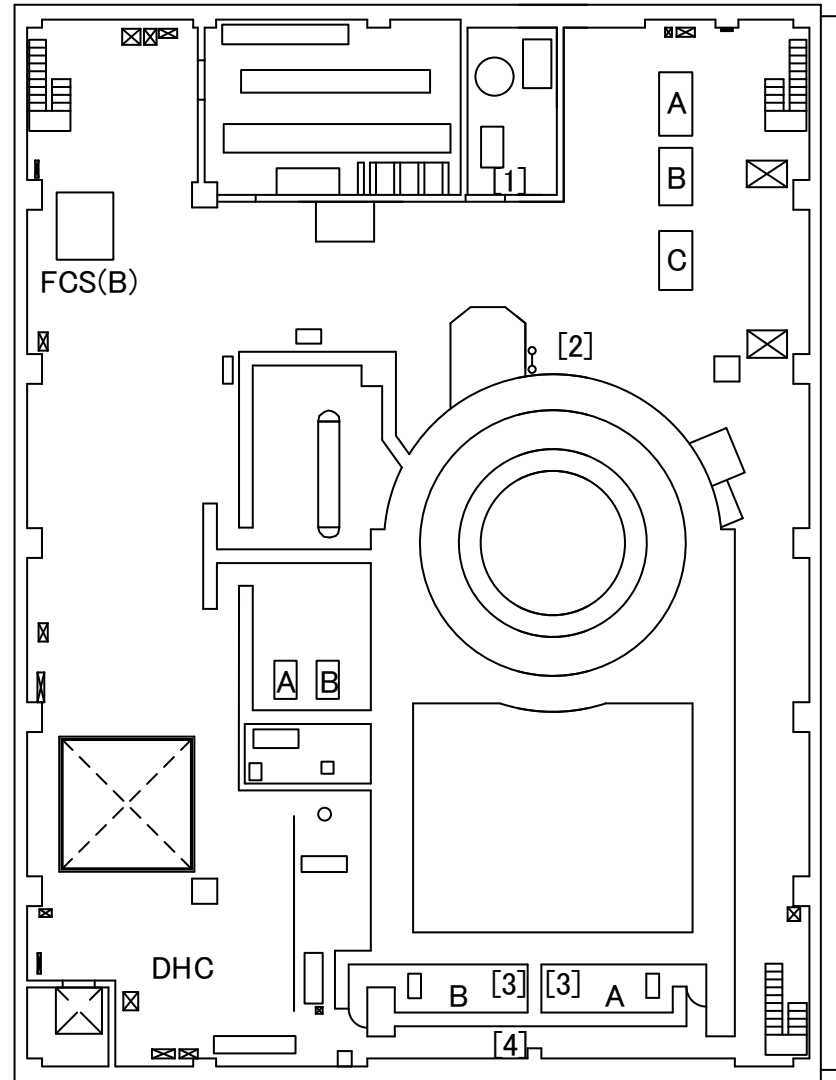
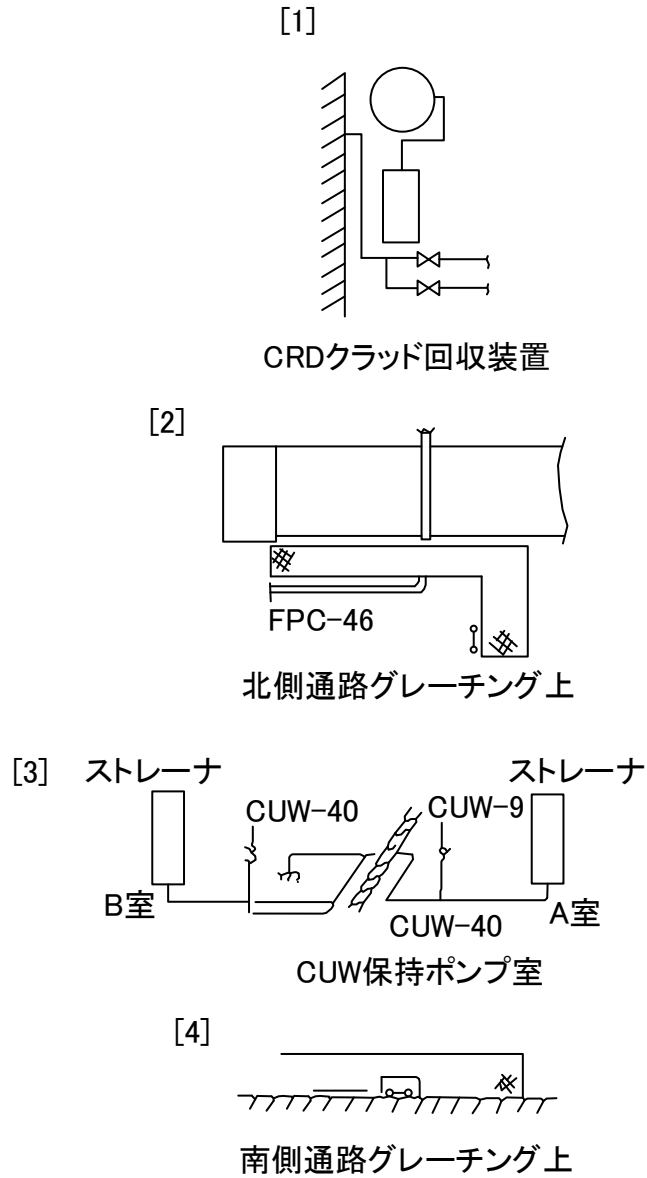

1F05RB004-00-01

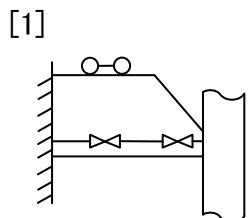

ウェル換気(東側)

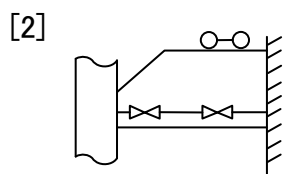

ウェル換気(西側)

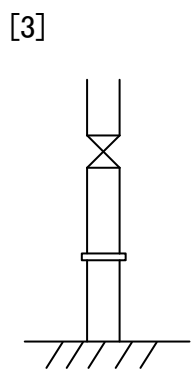

FPC-46

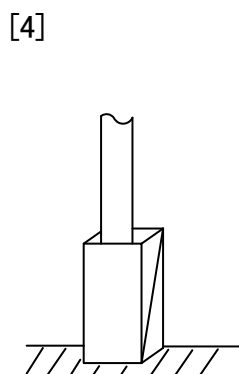

FPC-8

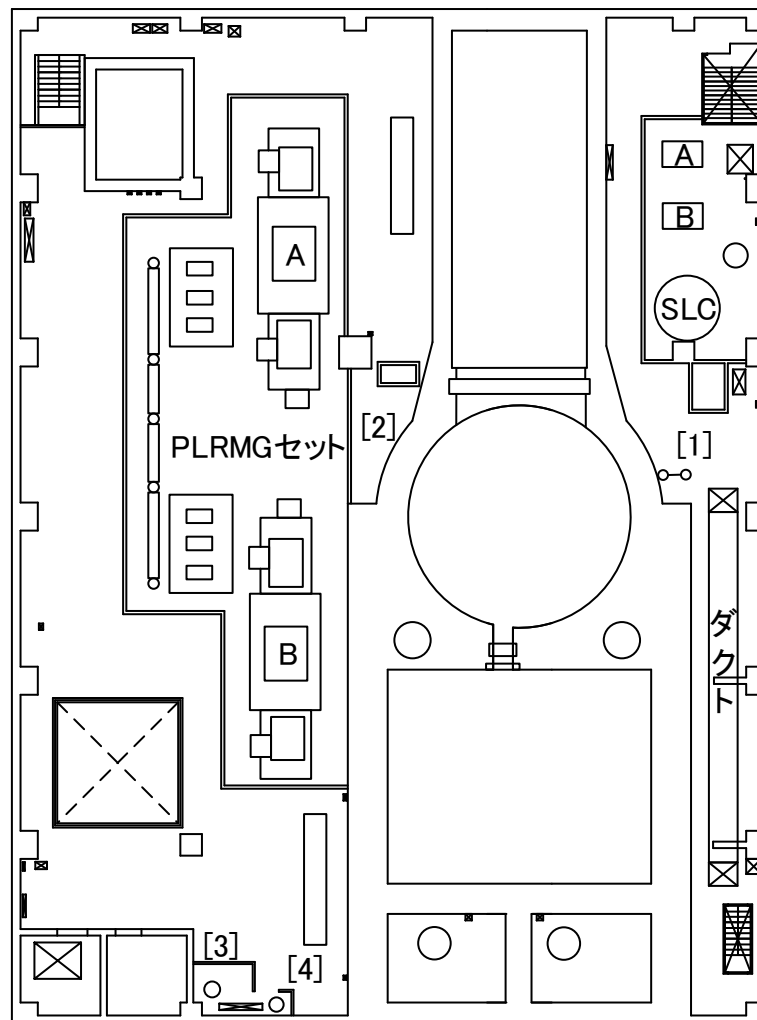

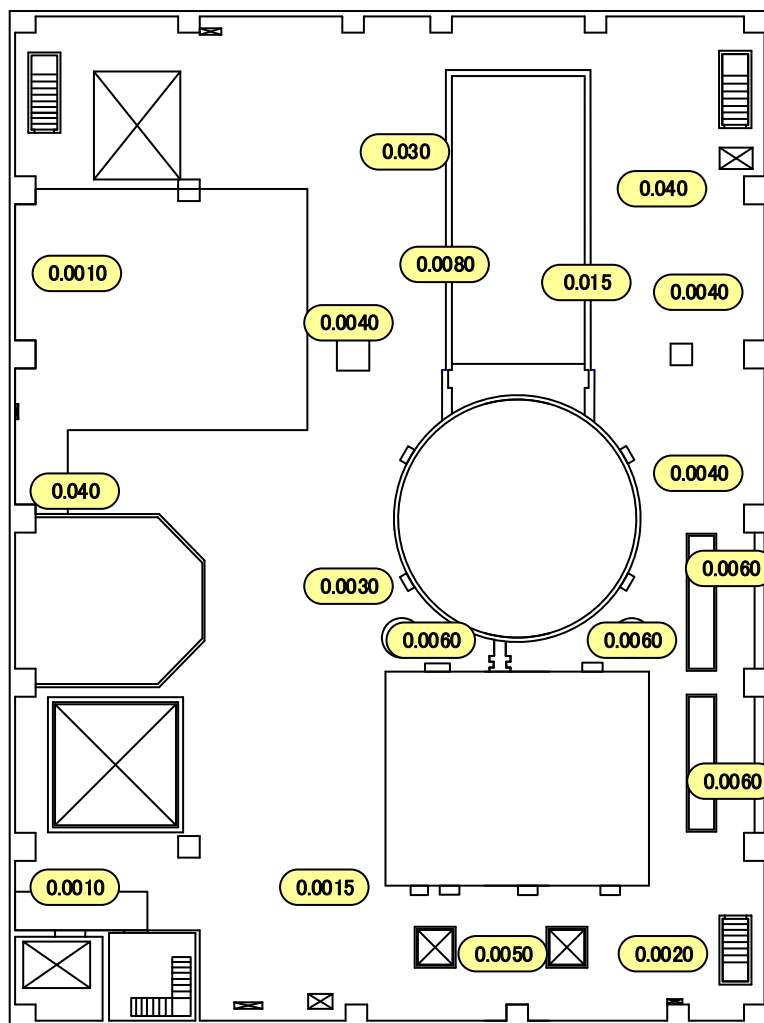

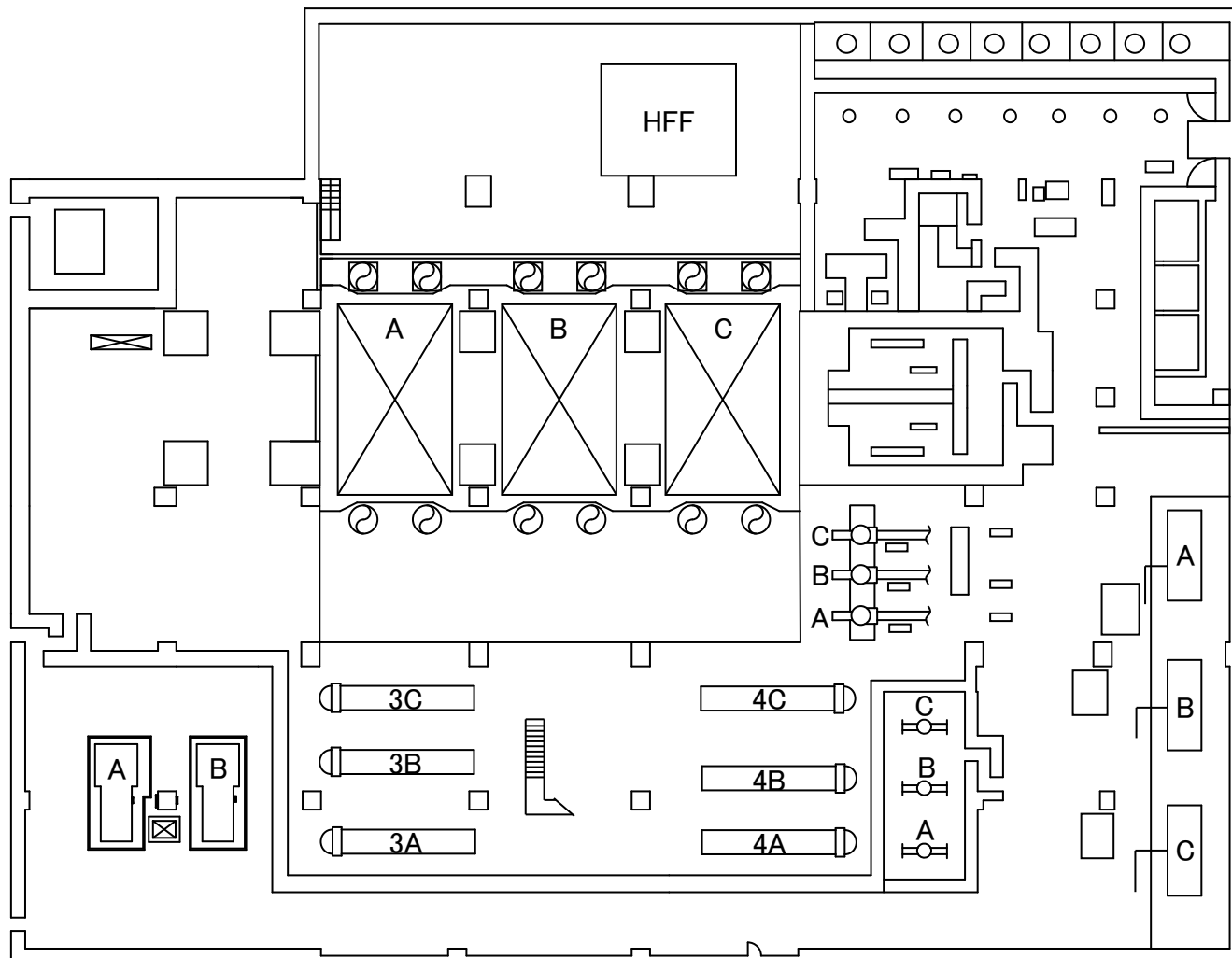

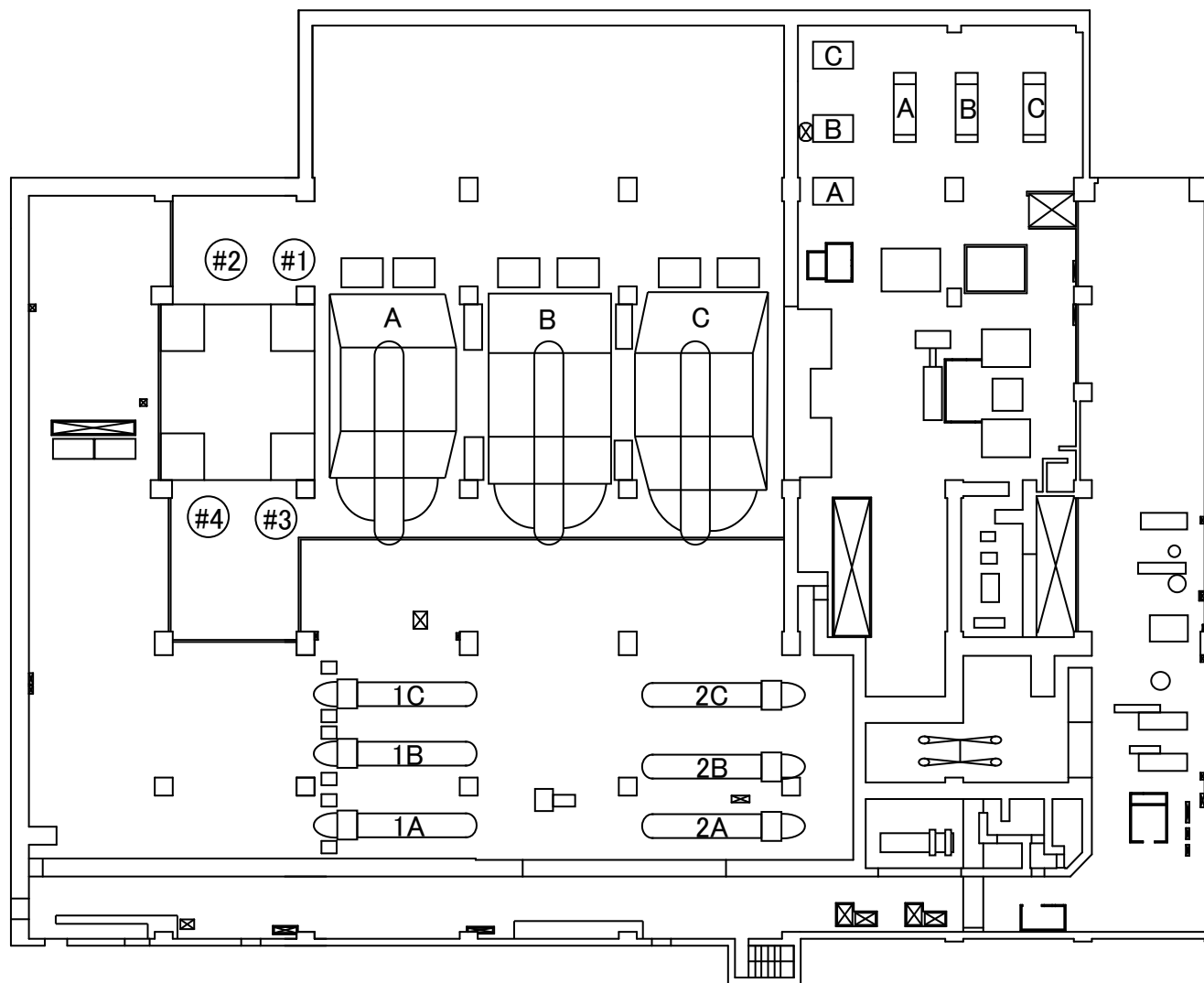

[1]
AS-23

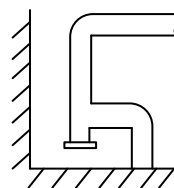

[2]
エバポレータ

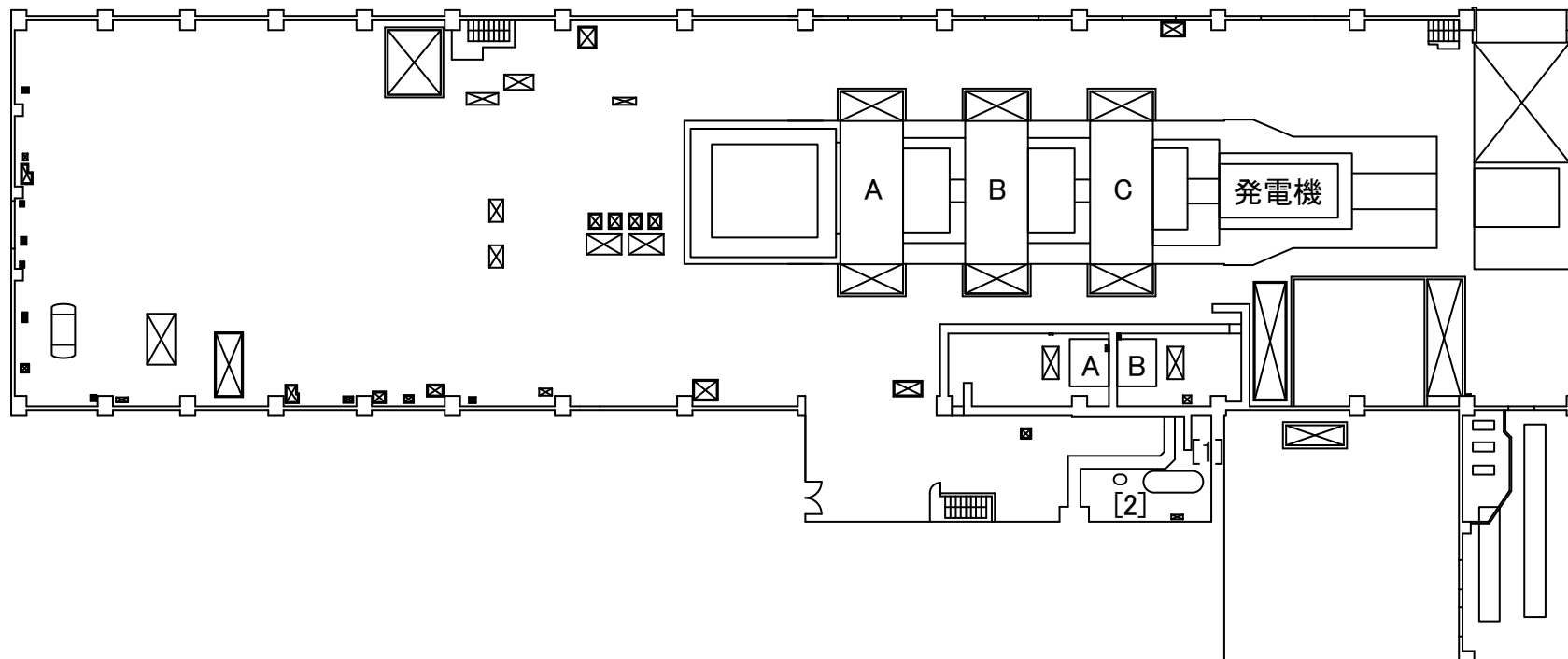
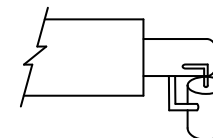

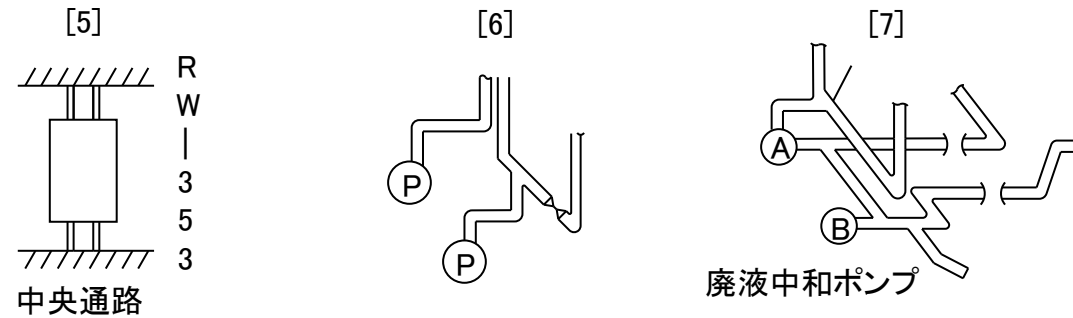
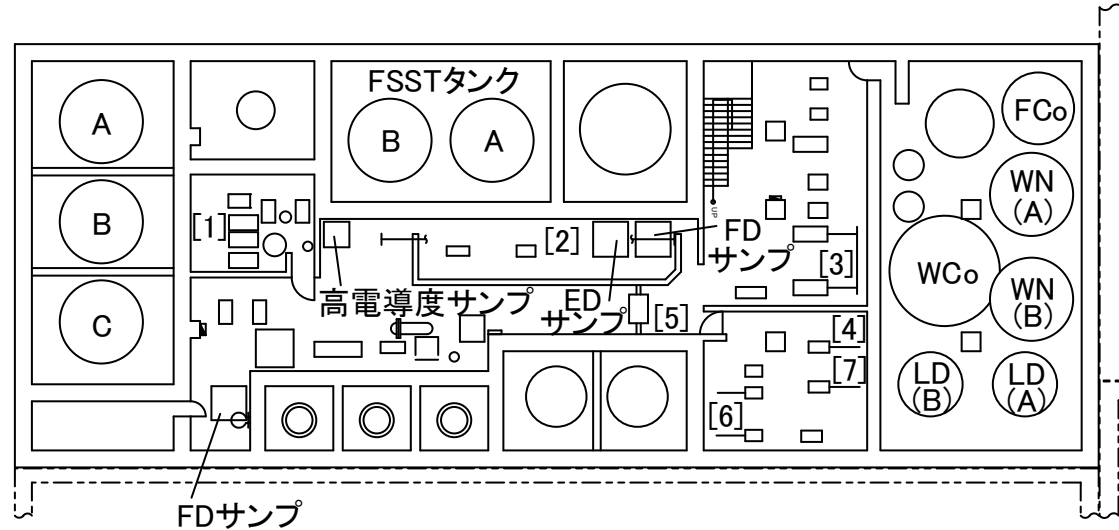
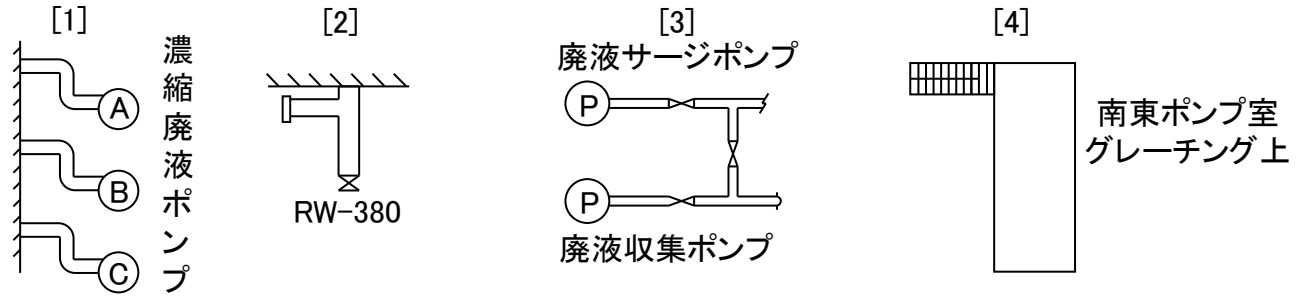

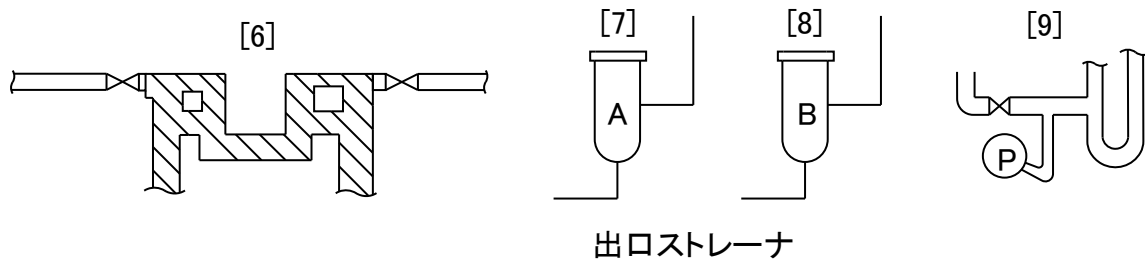
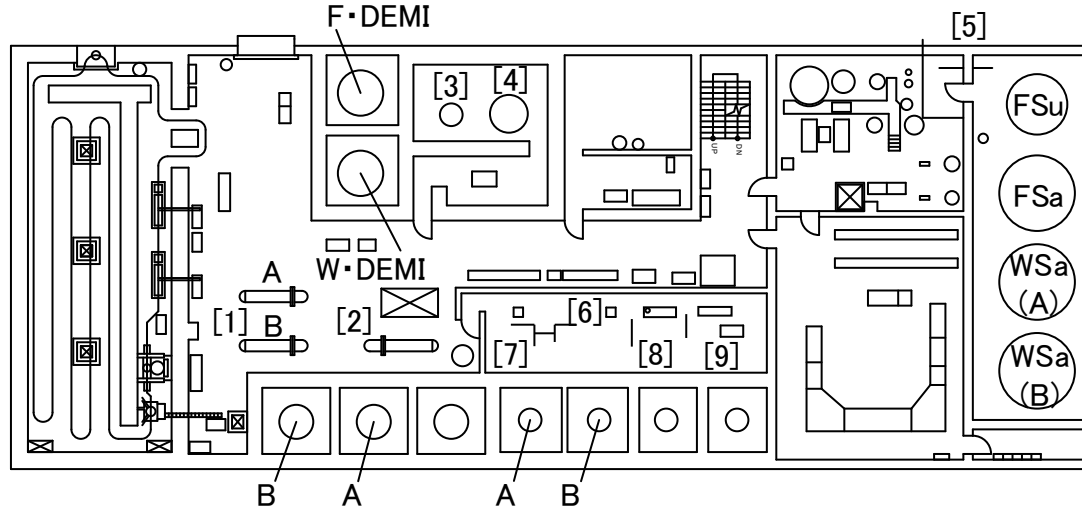
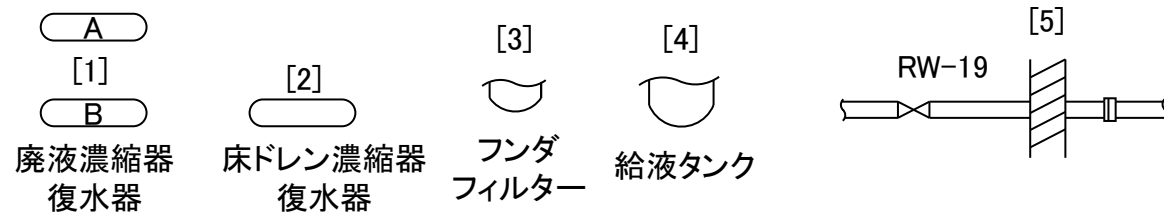

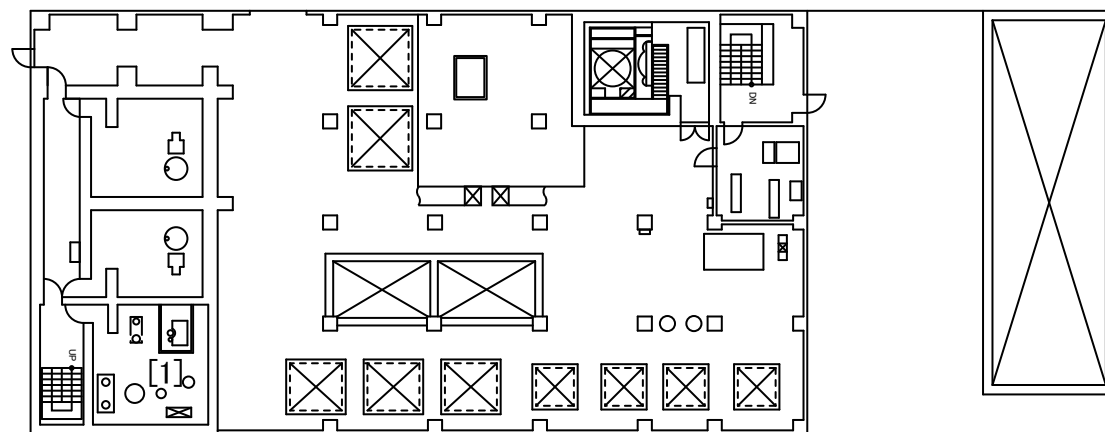

[1]



濃縮廃液計量タンク

