

2016年3月31日
東京電力株式会社

建屋内の空間線量率について

データ採取期間

- ・ 6号機 : 2016年1月1日～2016年1月31日

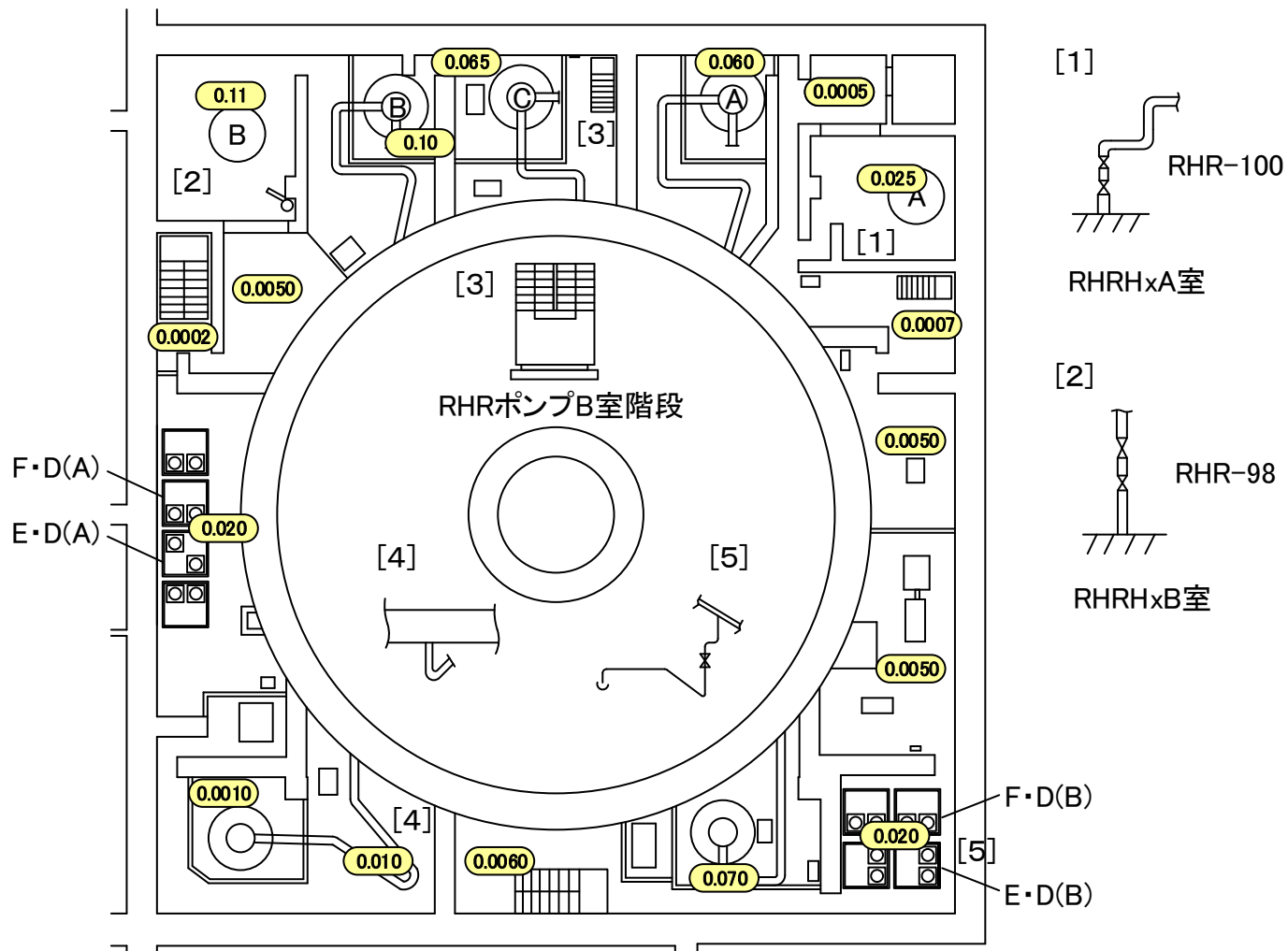

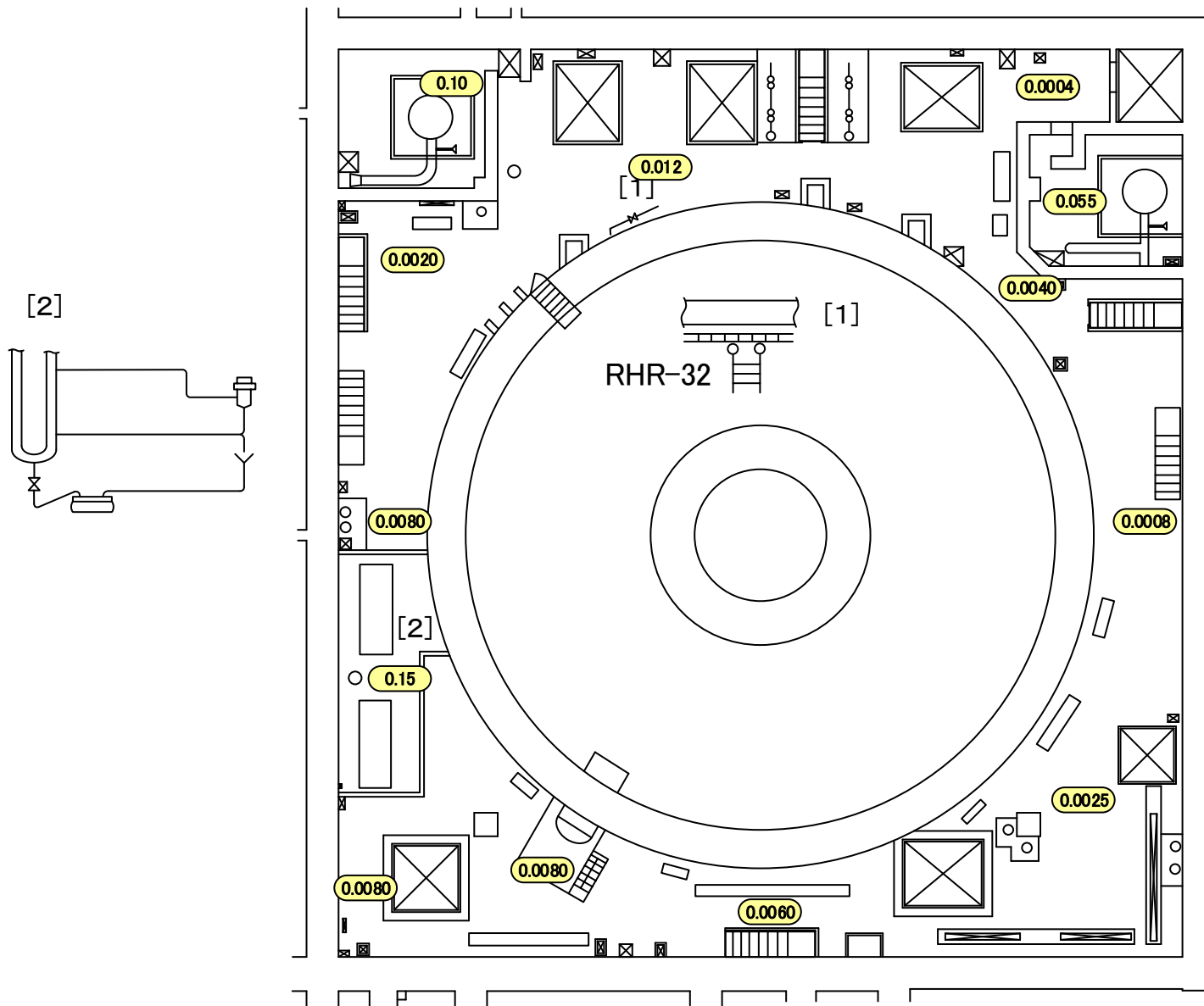

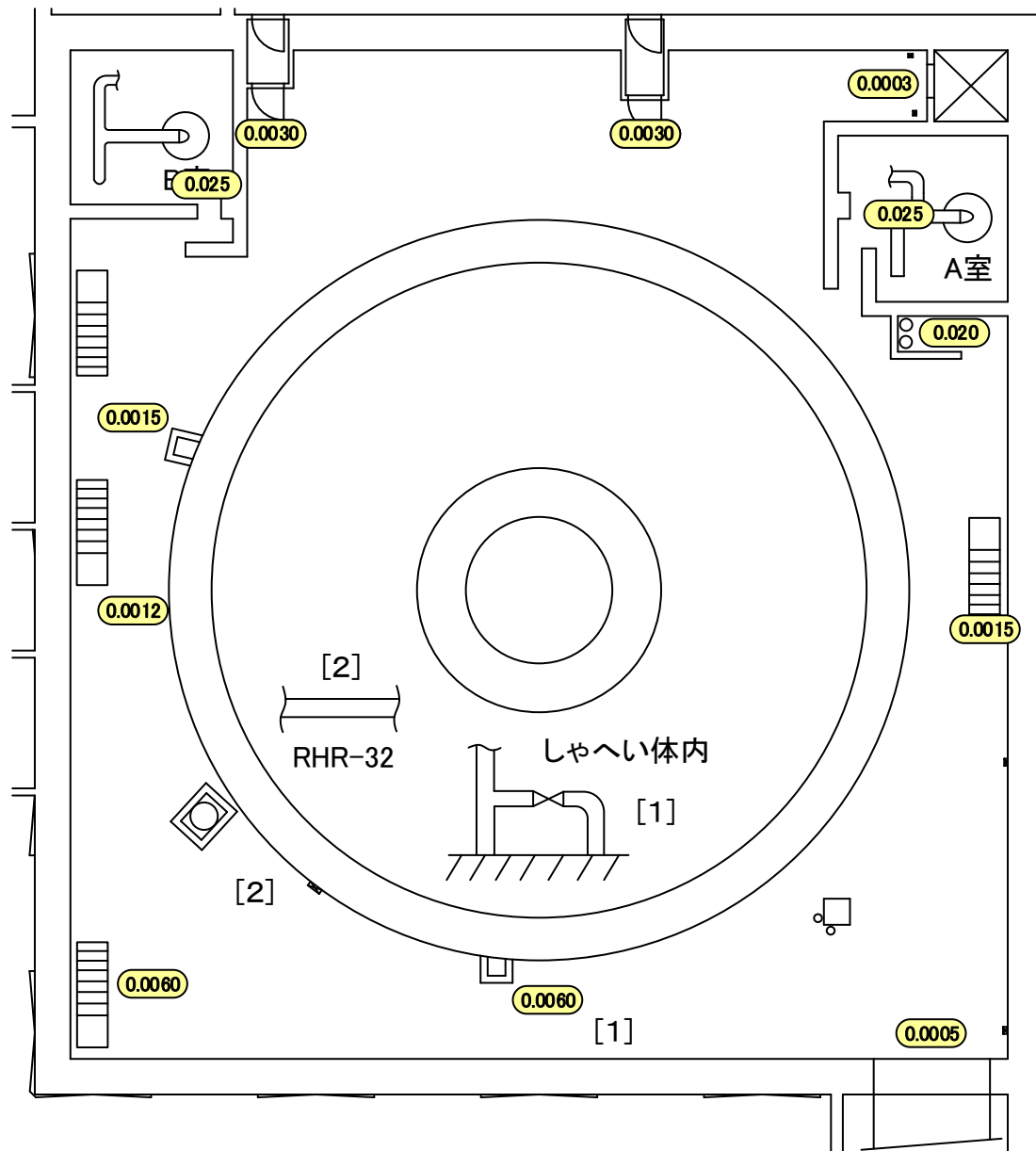

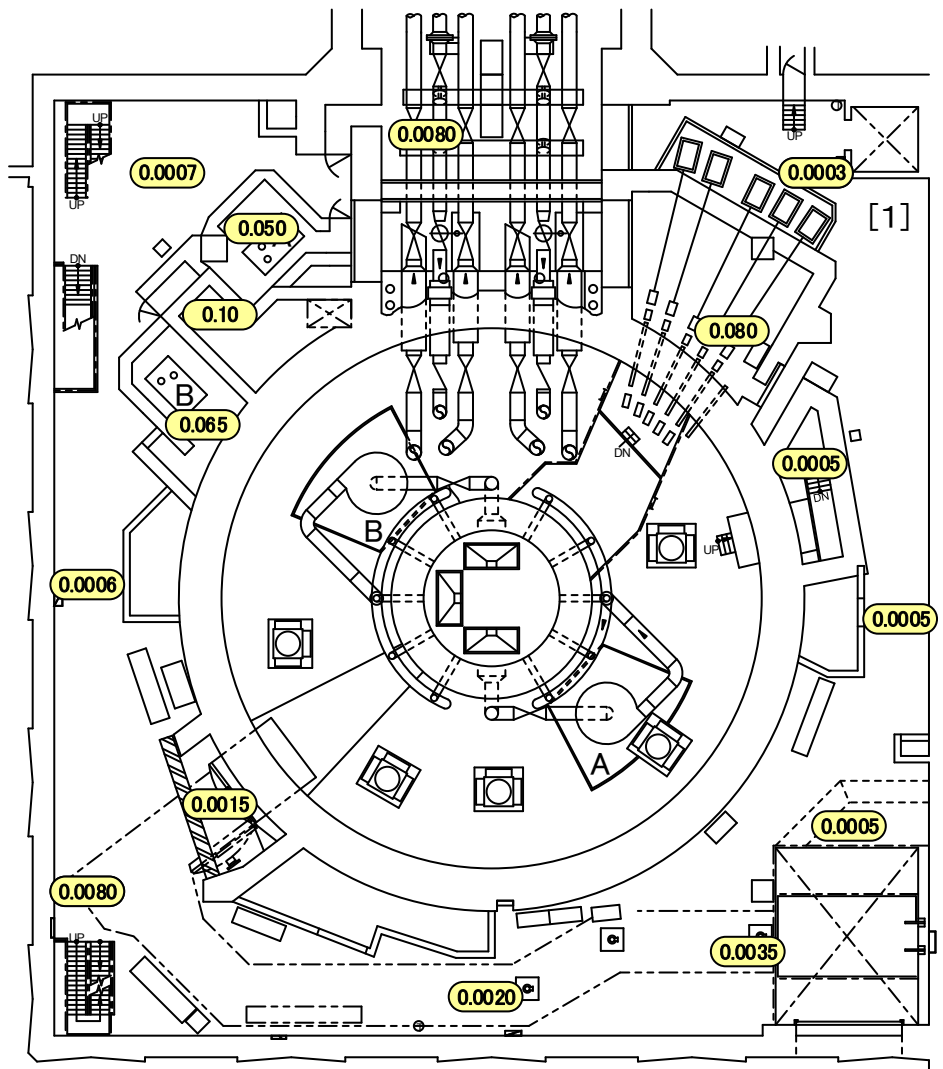

[1]

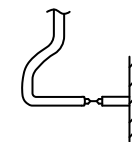

FPC-49

[1]
サンプリング
ラック

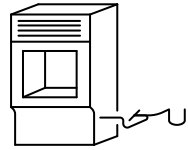

[2]
グレーチング
上

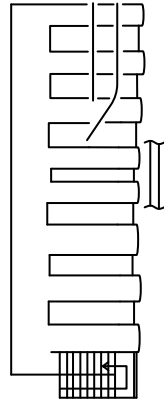

[3]
CRD吐出
フィルター

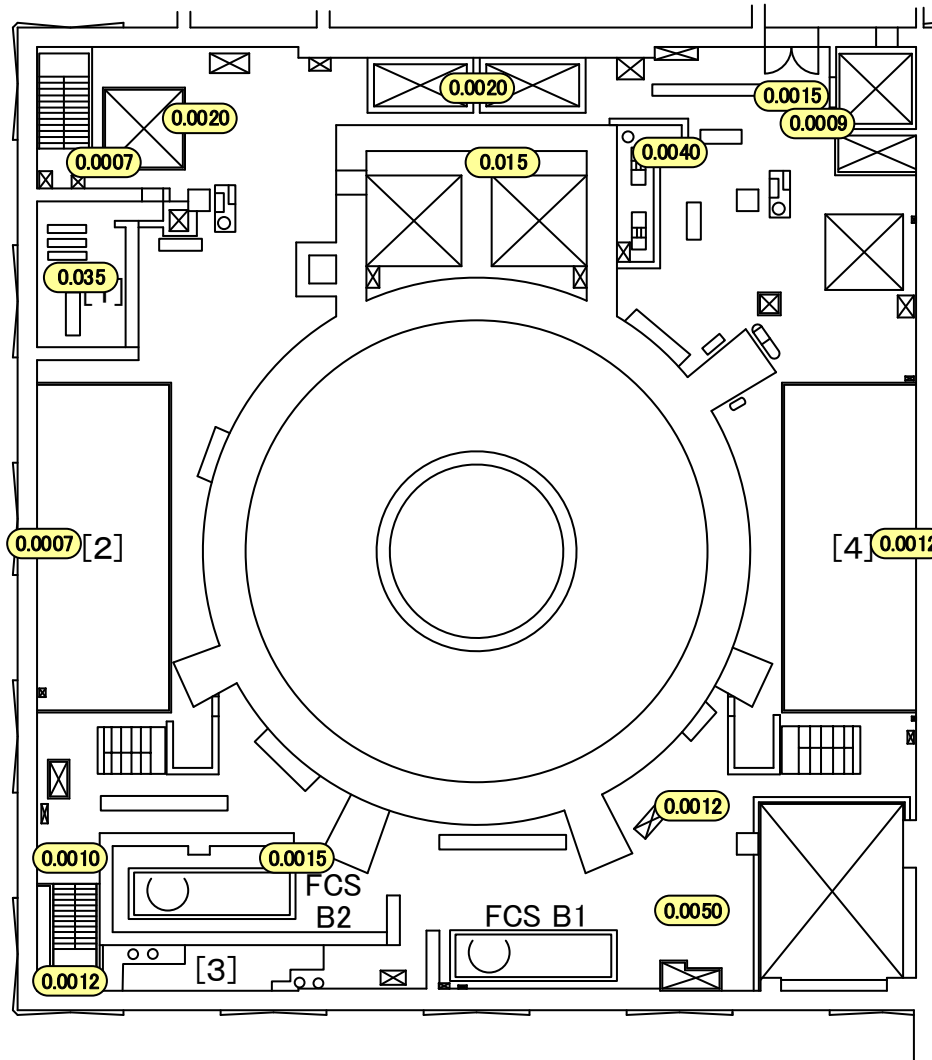
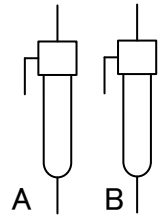

[4]
グレーチング
上

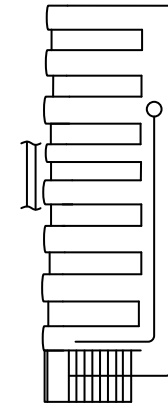

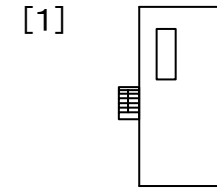
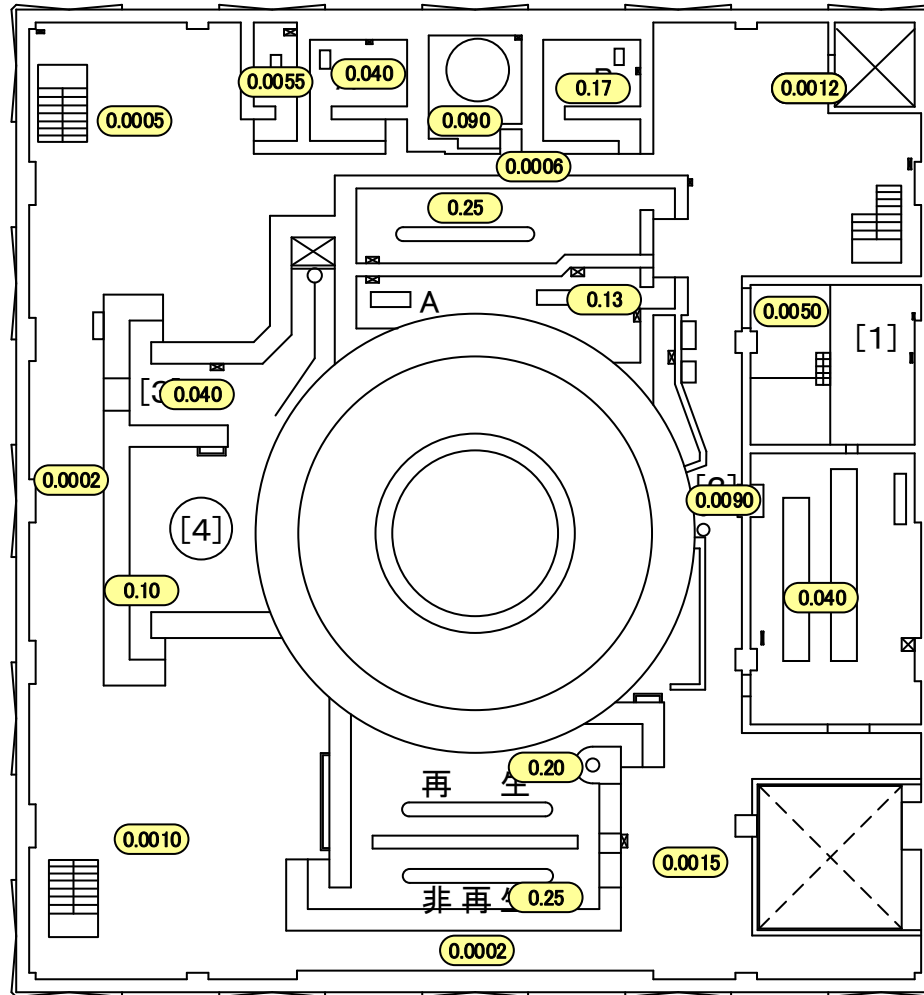

[1]
CRD半自動分解装置
操作エリア

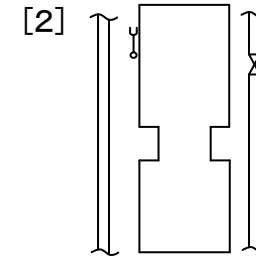

[2]
南側通路
グレーチング上

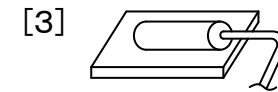

[3]
CUW逆洗水移送ポンプ

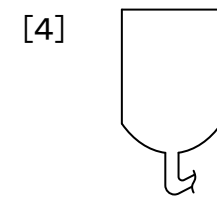

[4]
CUW逆洗水受タンク

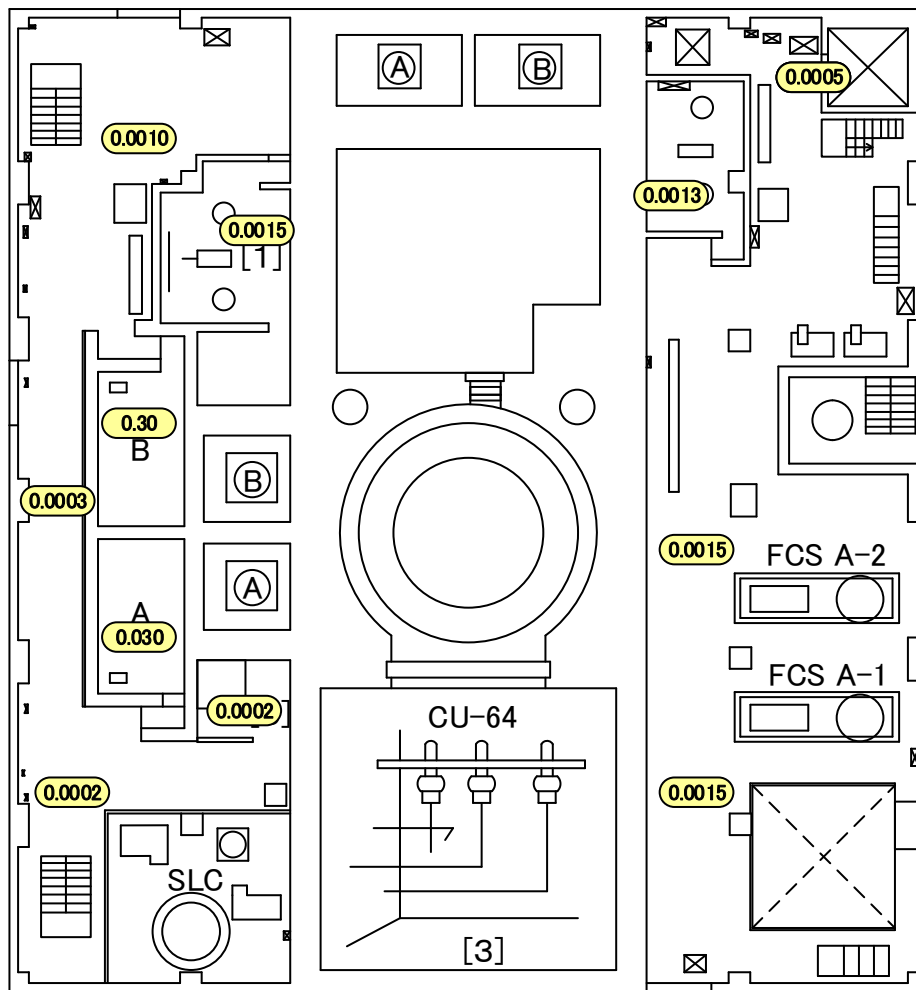
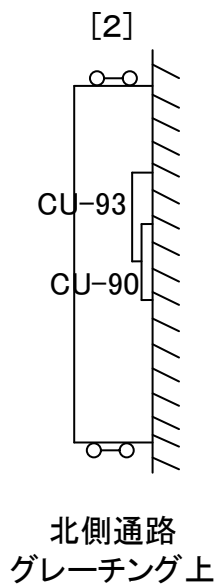
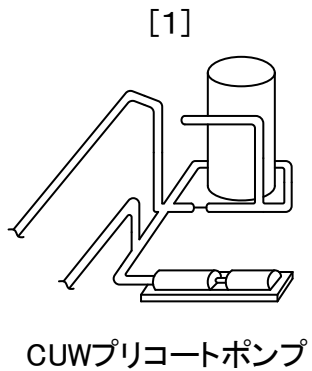

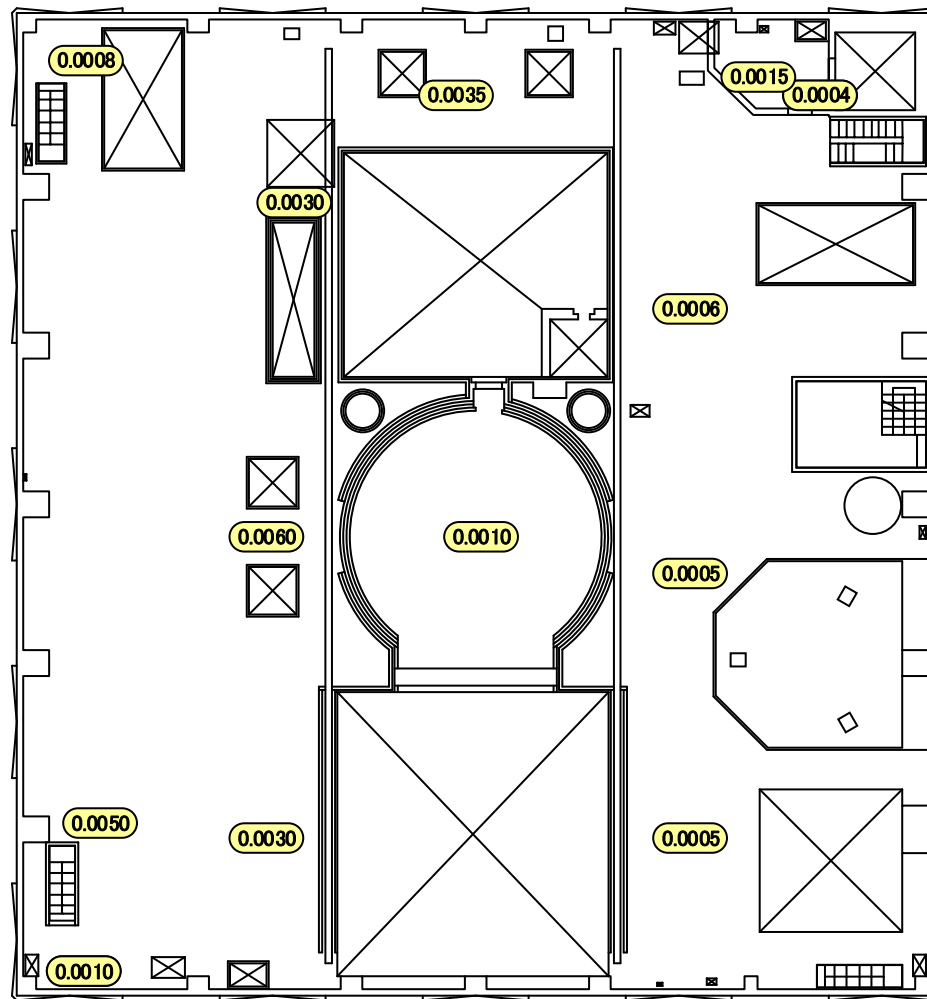

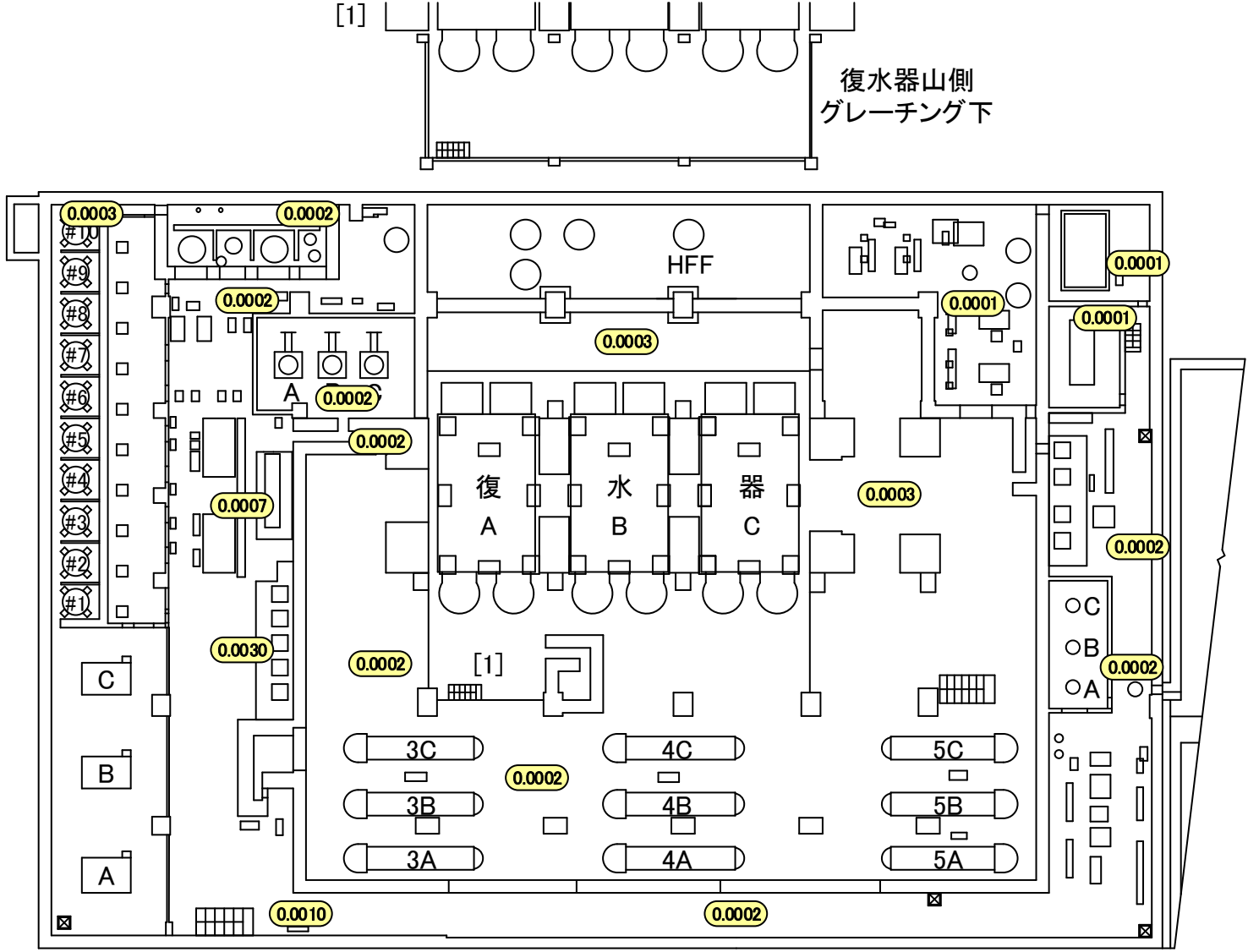

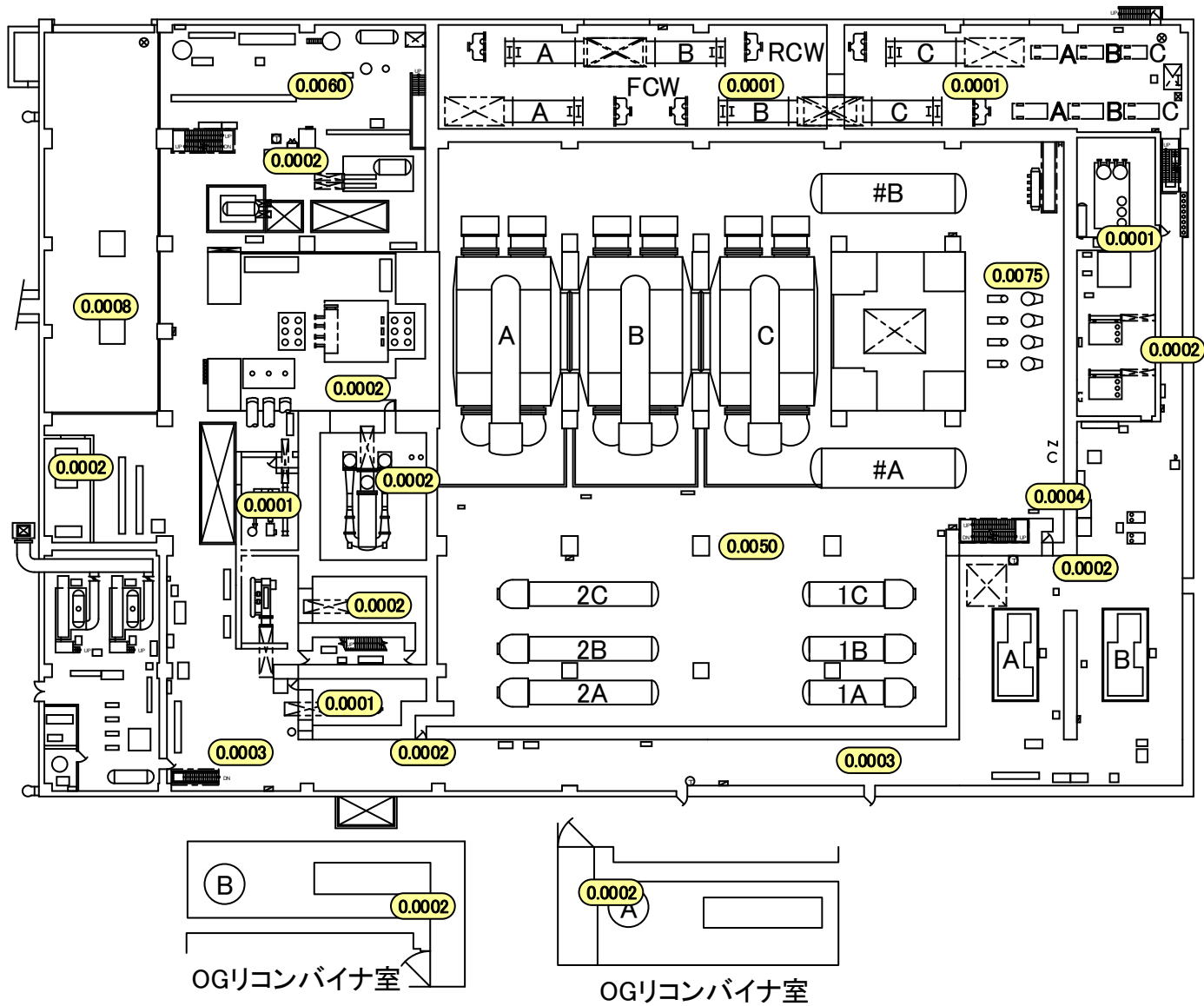

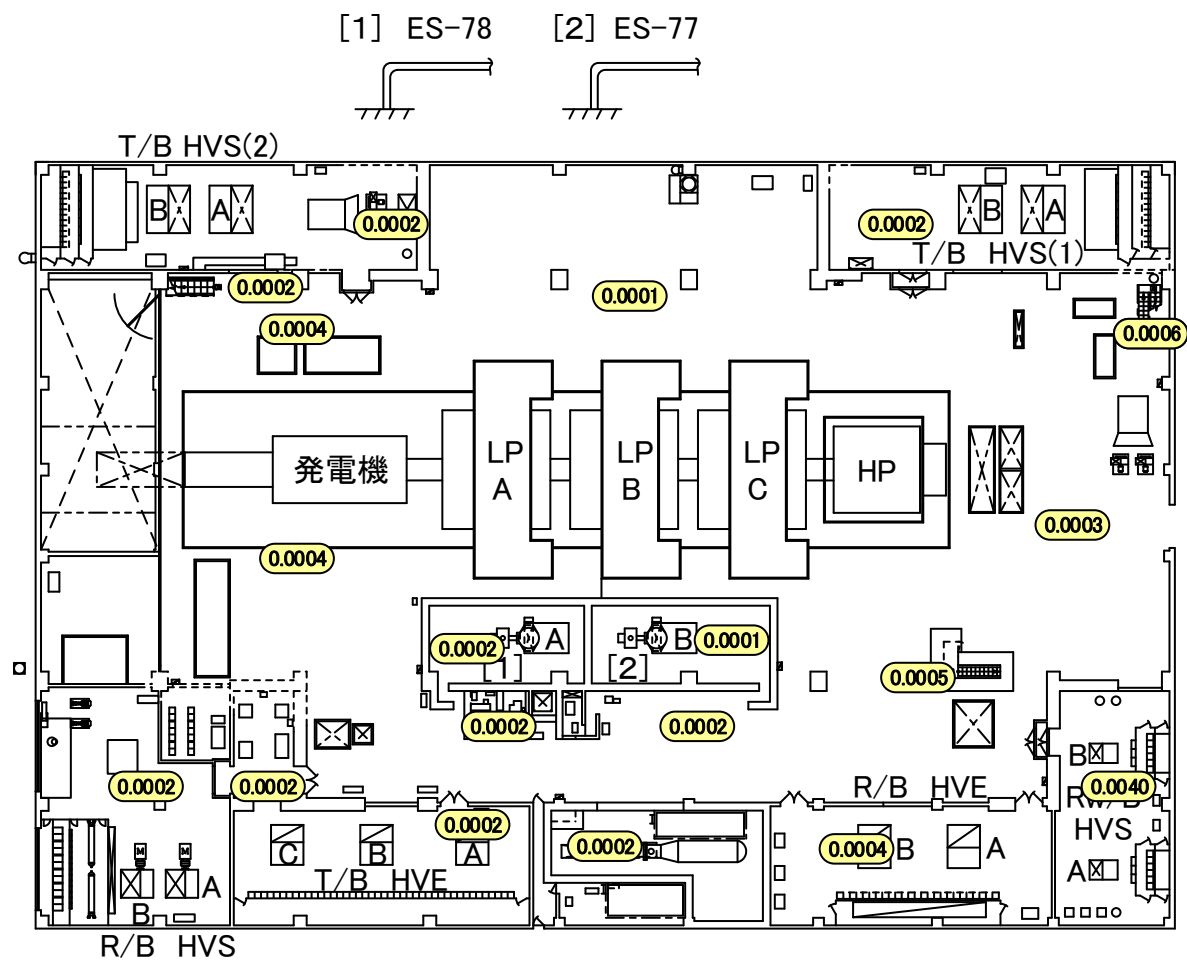

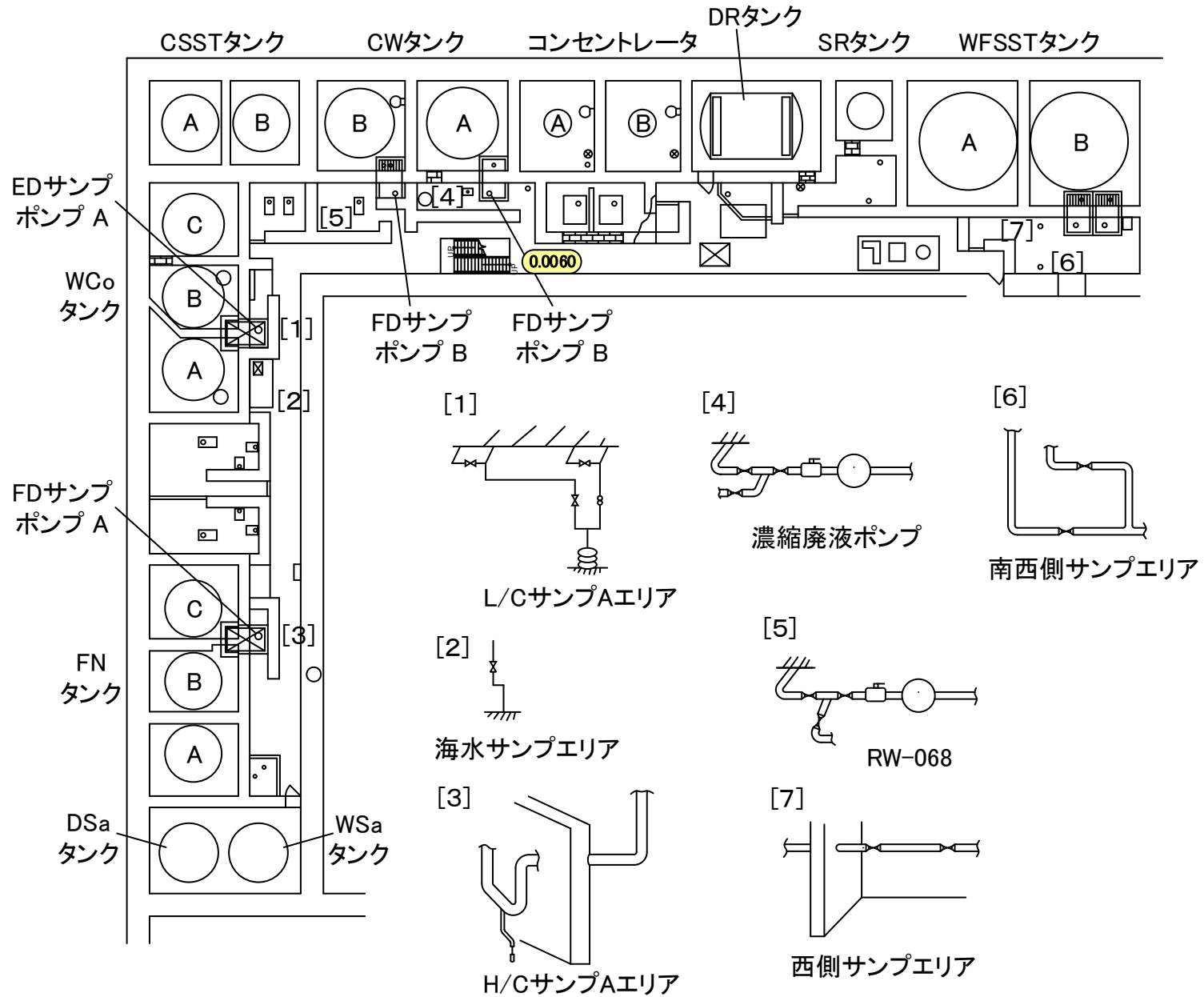

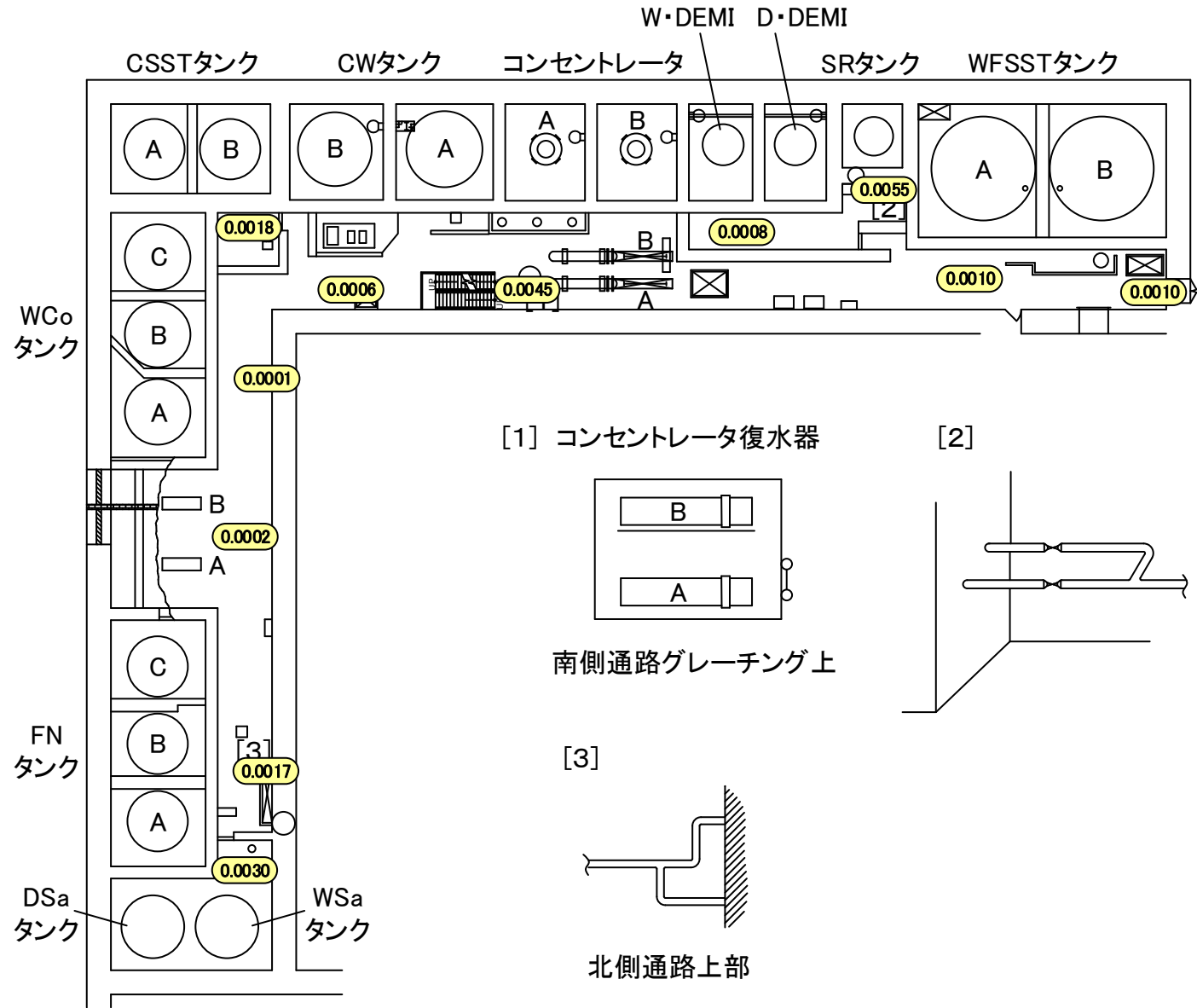

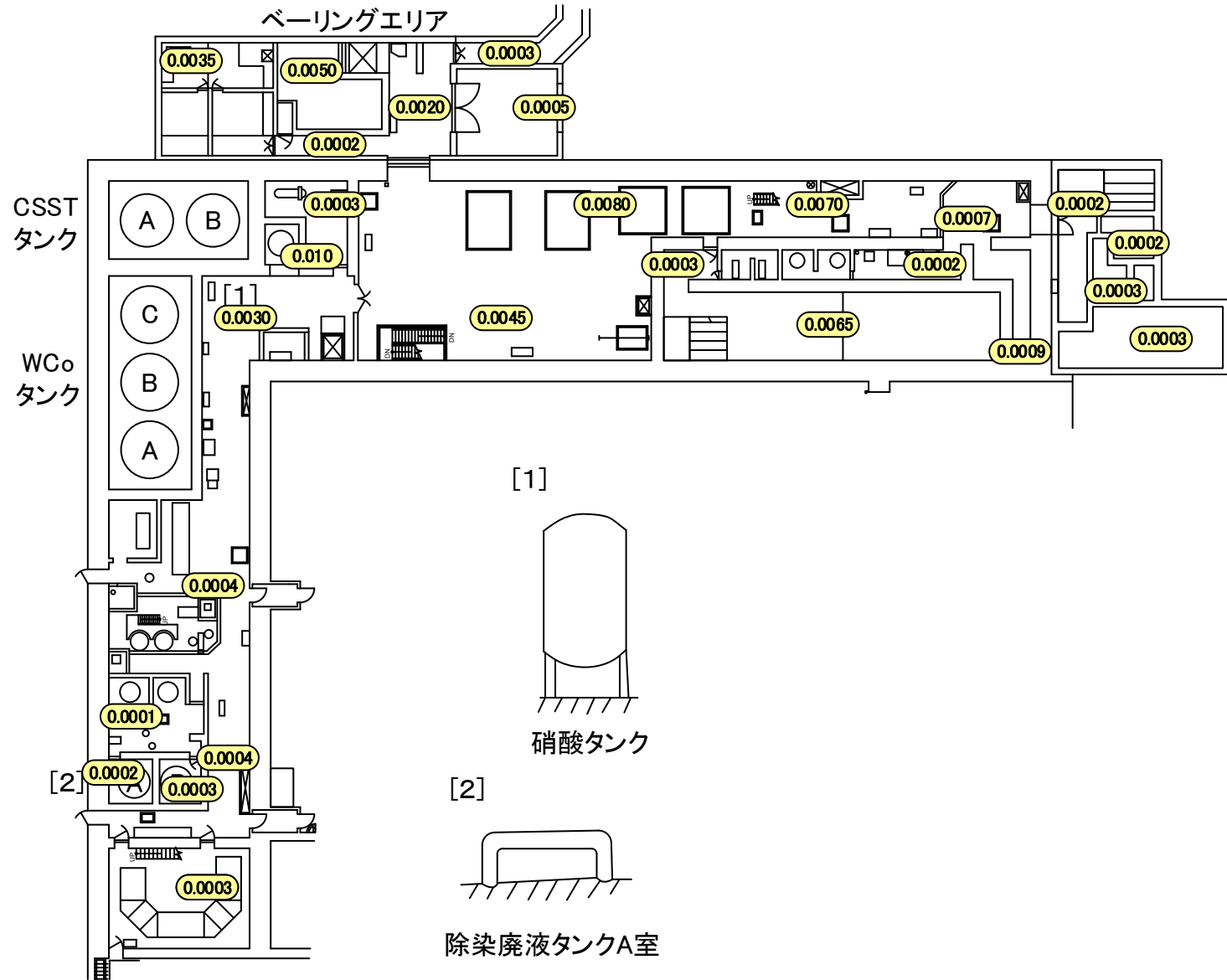

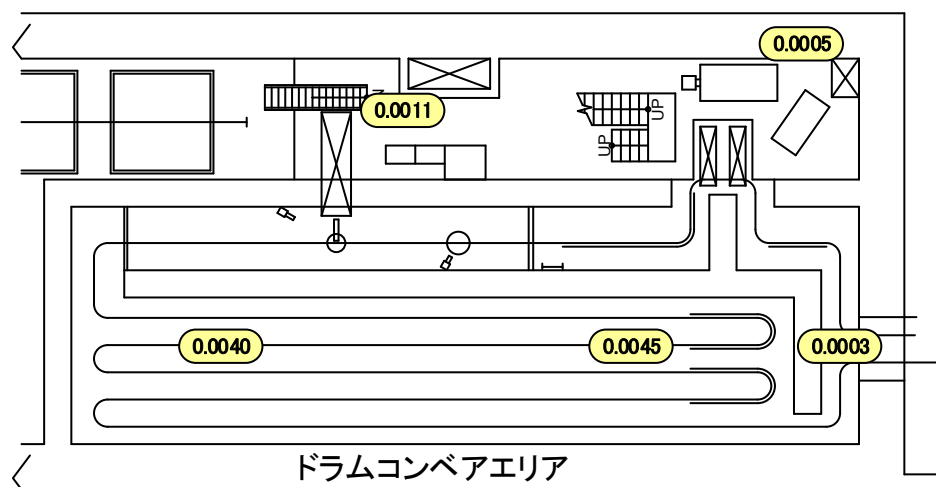

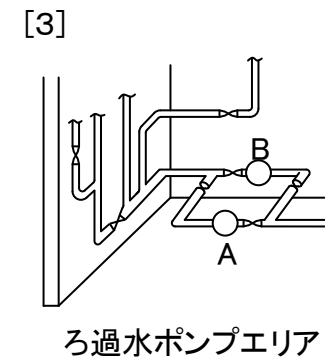
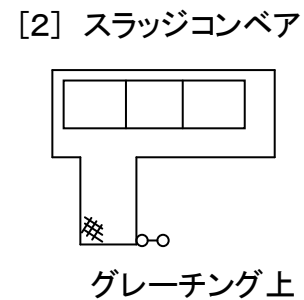
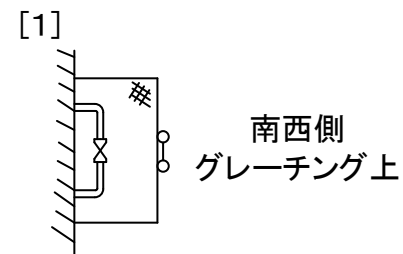
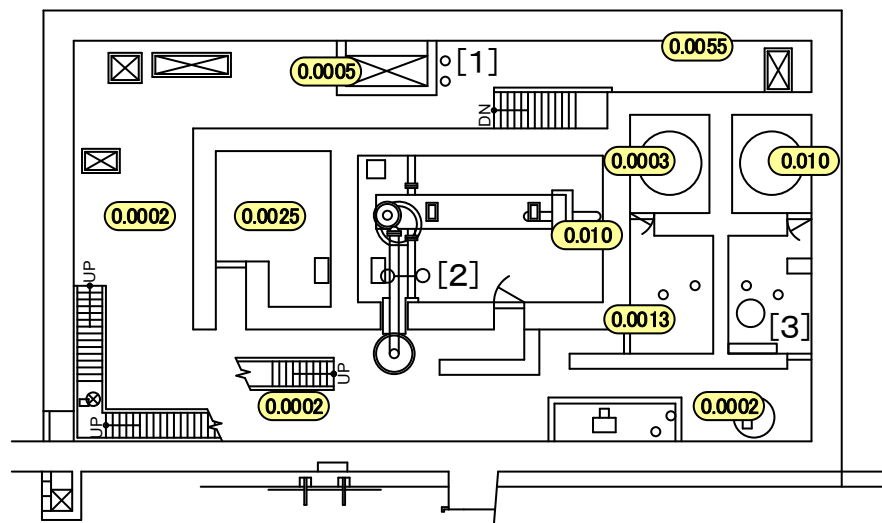

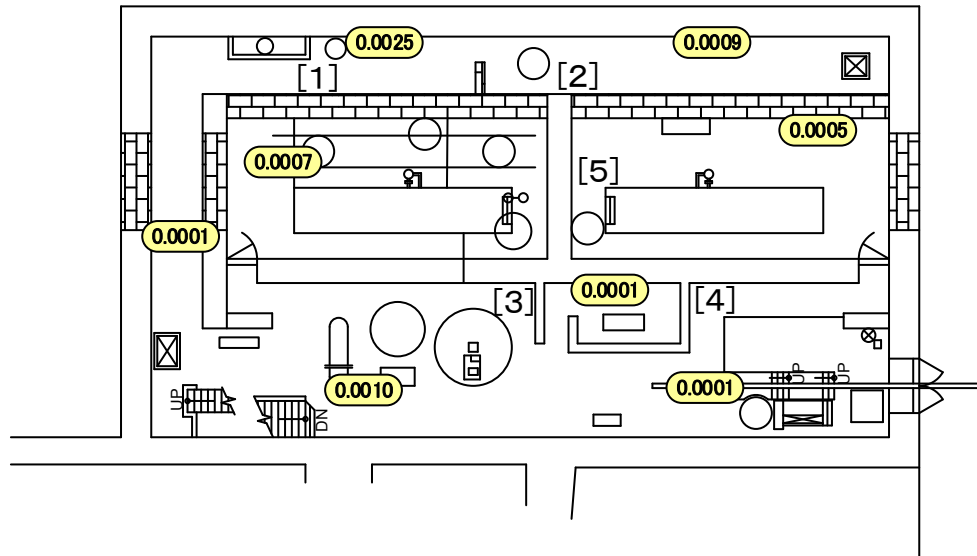

<D/G室>

非常用
D/G室

HPCS
D/G室

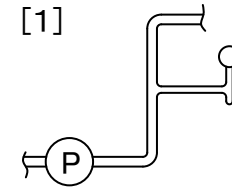

機器ドレン補助ろ過器ポンプ

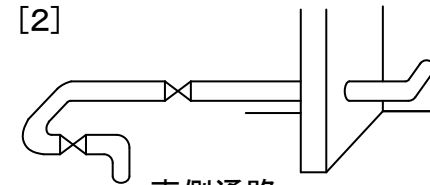

東側通路

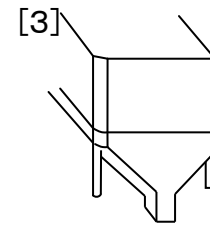

機器ドレンTBF

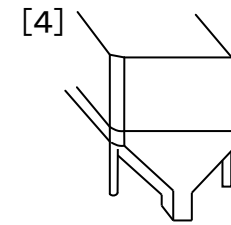

床ドレンTBF

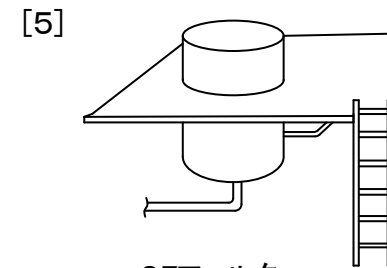

SFフィルター