<Reference>
March 22, 2013
Tokyo Electric Power Company

Air dose rates in the buildings

Data collection period (1/2)

- Unit 1: April, 2011 - February (2/18), 2013
- Unit 2: April, 2011 - February (2/18), 2013
- Unit 3: April (4/25), 2011 - February (2/18), 2013
- Unit 4: March (3/31), 2011 - February (2/18), 2013
- Unit 5: February (2/25), 2013
- Unit 6: February (2/26), 2013

Data collection period (2/2)

- Process Main Building (PM):
April, 2011 – February (2/18), 2013
- Incineration Workshop Building (MSW):
May, 2011 – February (2/14), 2013
- Miscellaneous Solid Waste Volume Reduction Treatment Building (HTI):
April, 2011 – February (2/13), 2013
- Side Bunker Building (SB):
May, 2011 – March (3/7), 2012
- Suppression Pool Water Surge-Tank Building (SPT)
May, 2011 – November (11/30), 2012
- Auxiliary Operation Shared Facility:
August, 2011 – January (1/18), 2013

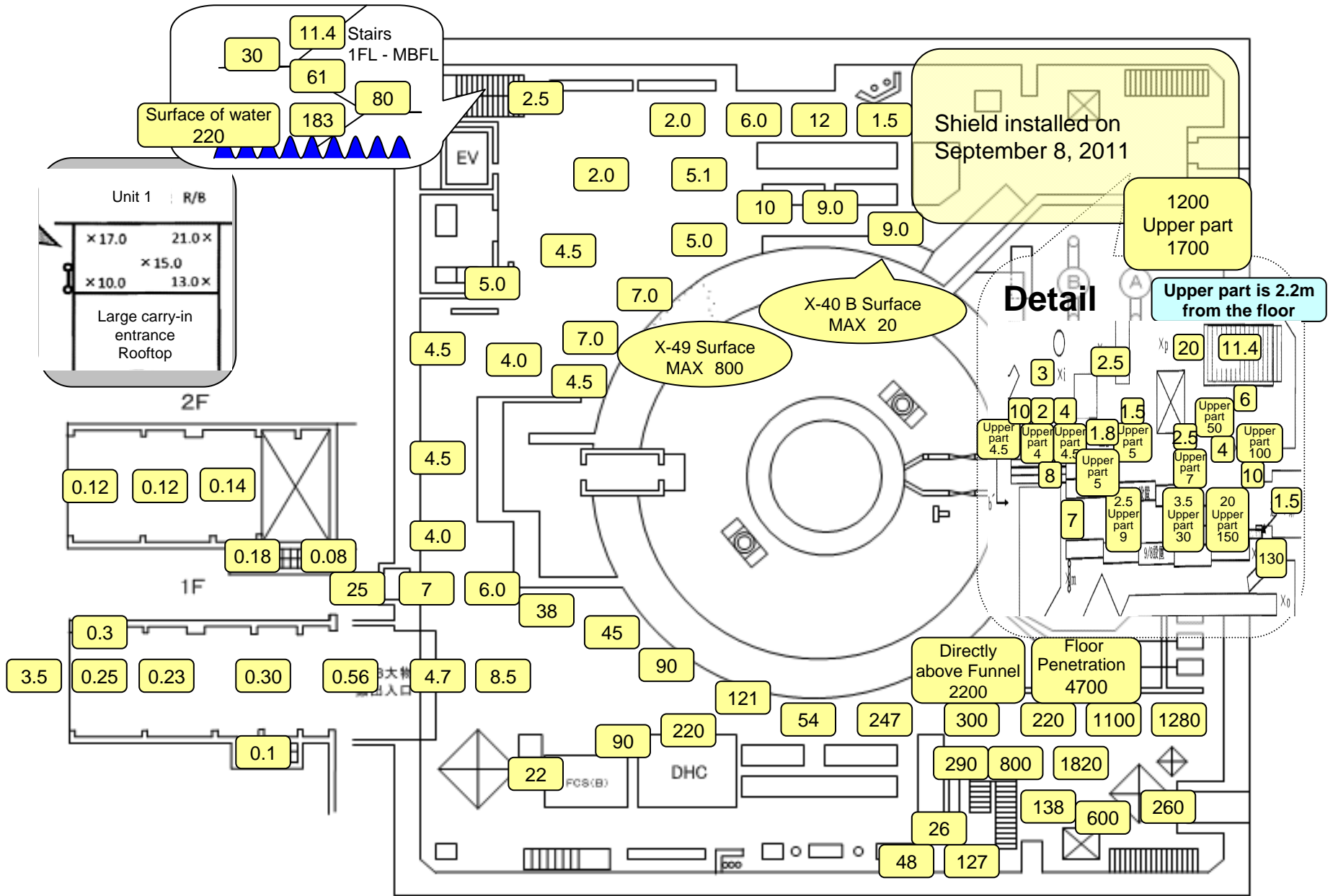

Unit 1 Reactor Building 1F

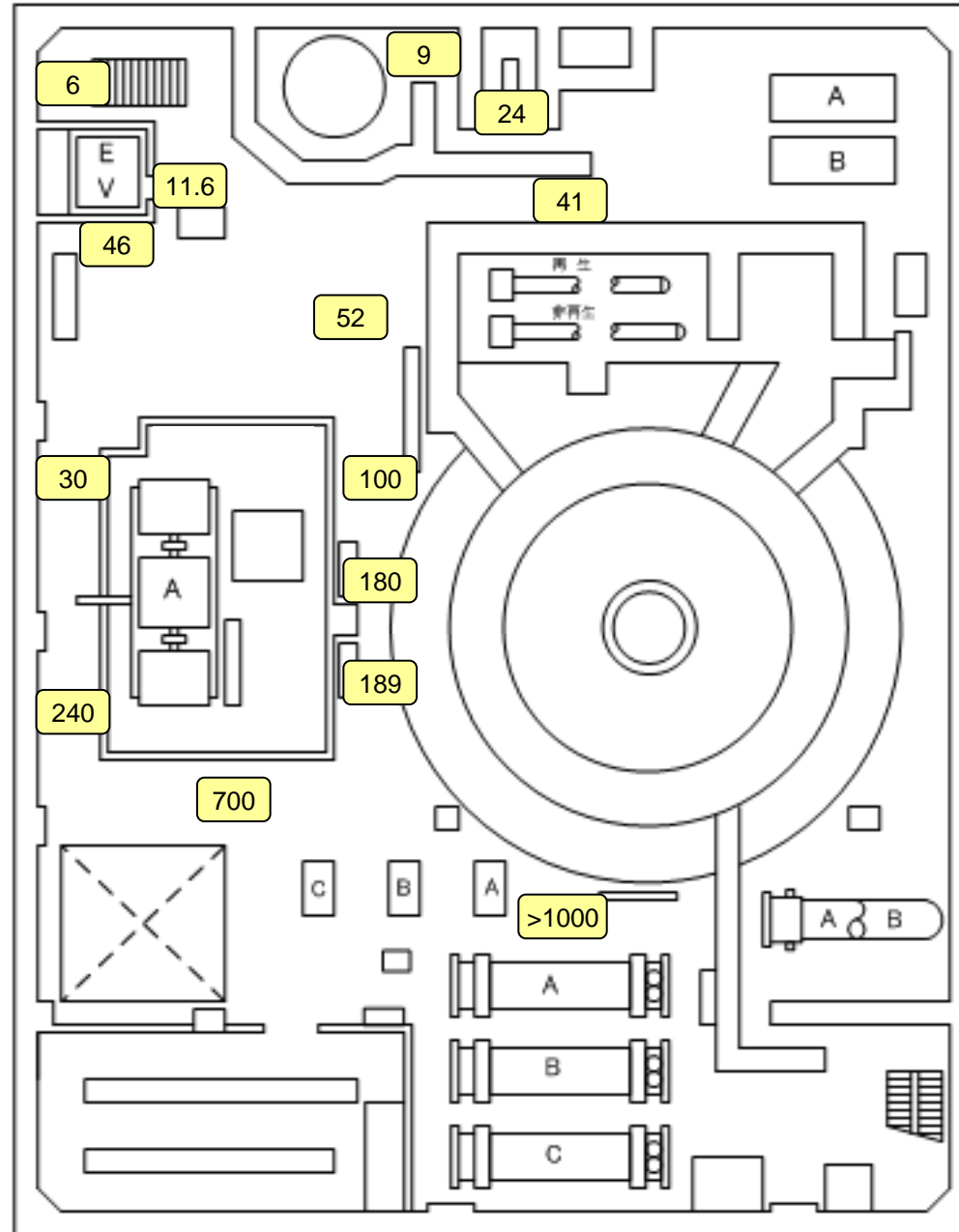

Unit: mSv/h

Unit 1 Reactor Building 2F

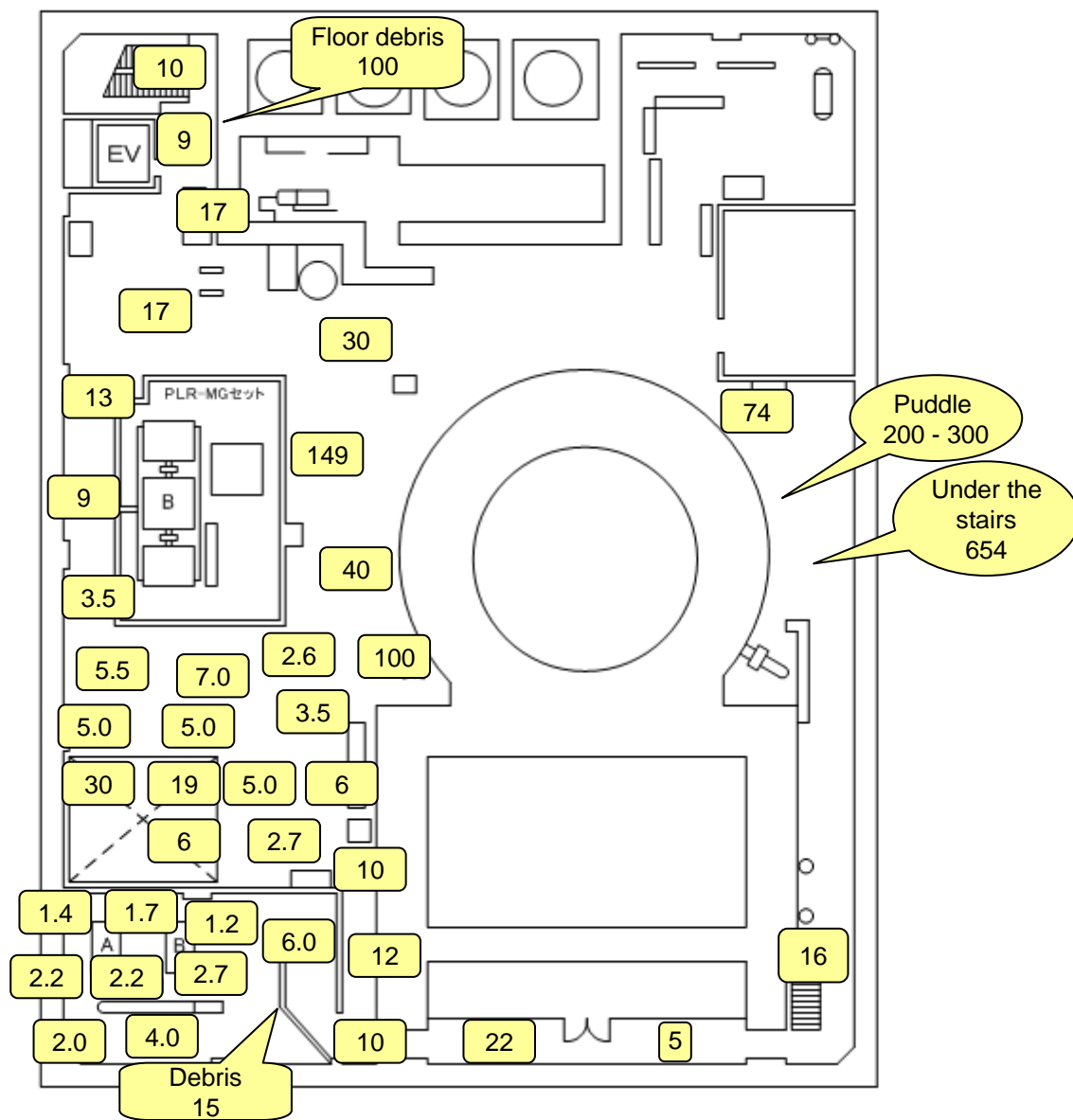

Unit: mSv/h

Unit 1 Reactor Building 3F

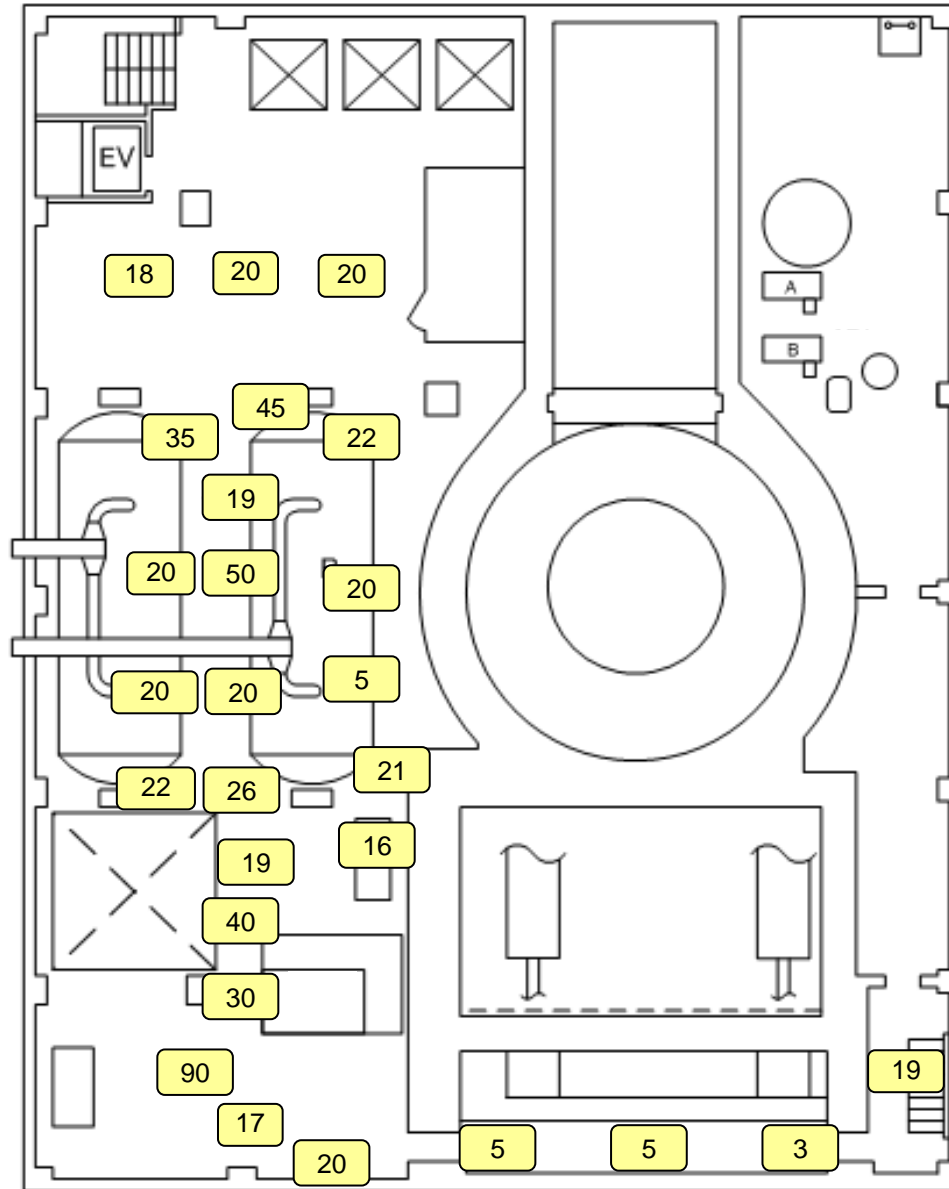

Unit: mSv/h

Unit 1 Reactor Building 4F

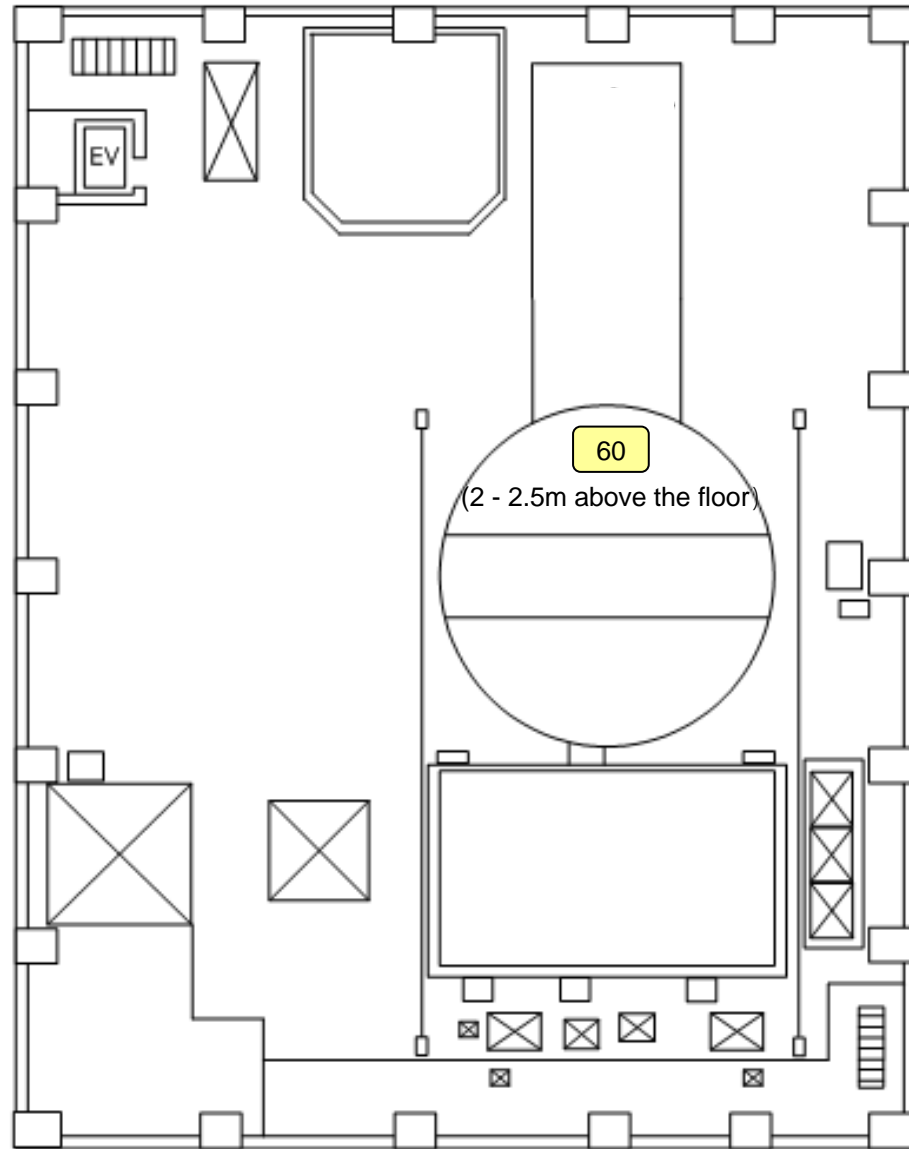

Unit: mSv/h

Unit 1 Reactor Building 5F

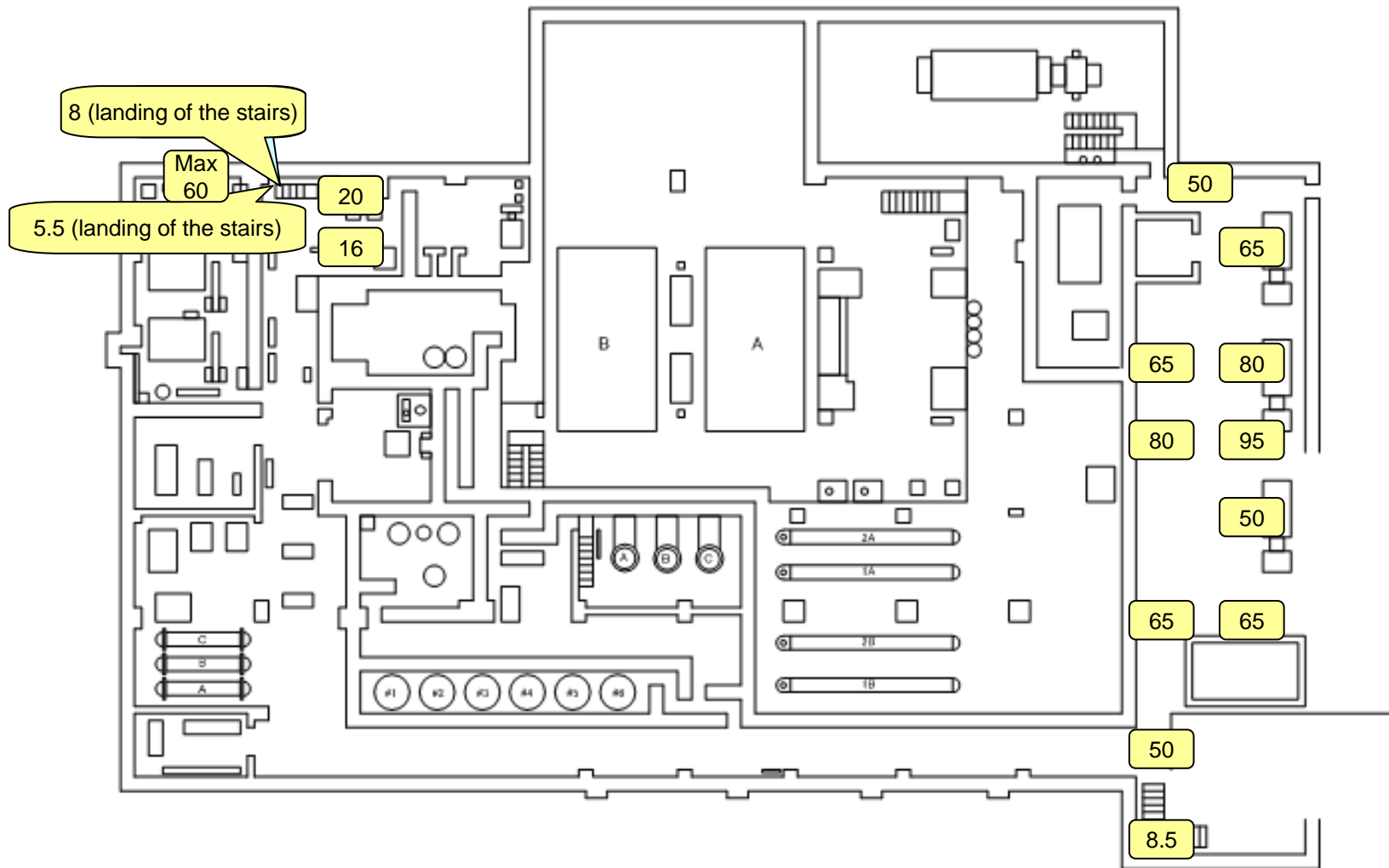

Unit: mSv/h

Unit 1 Turbine Building B1F

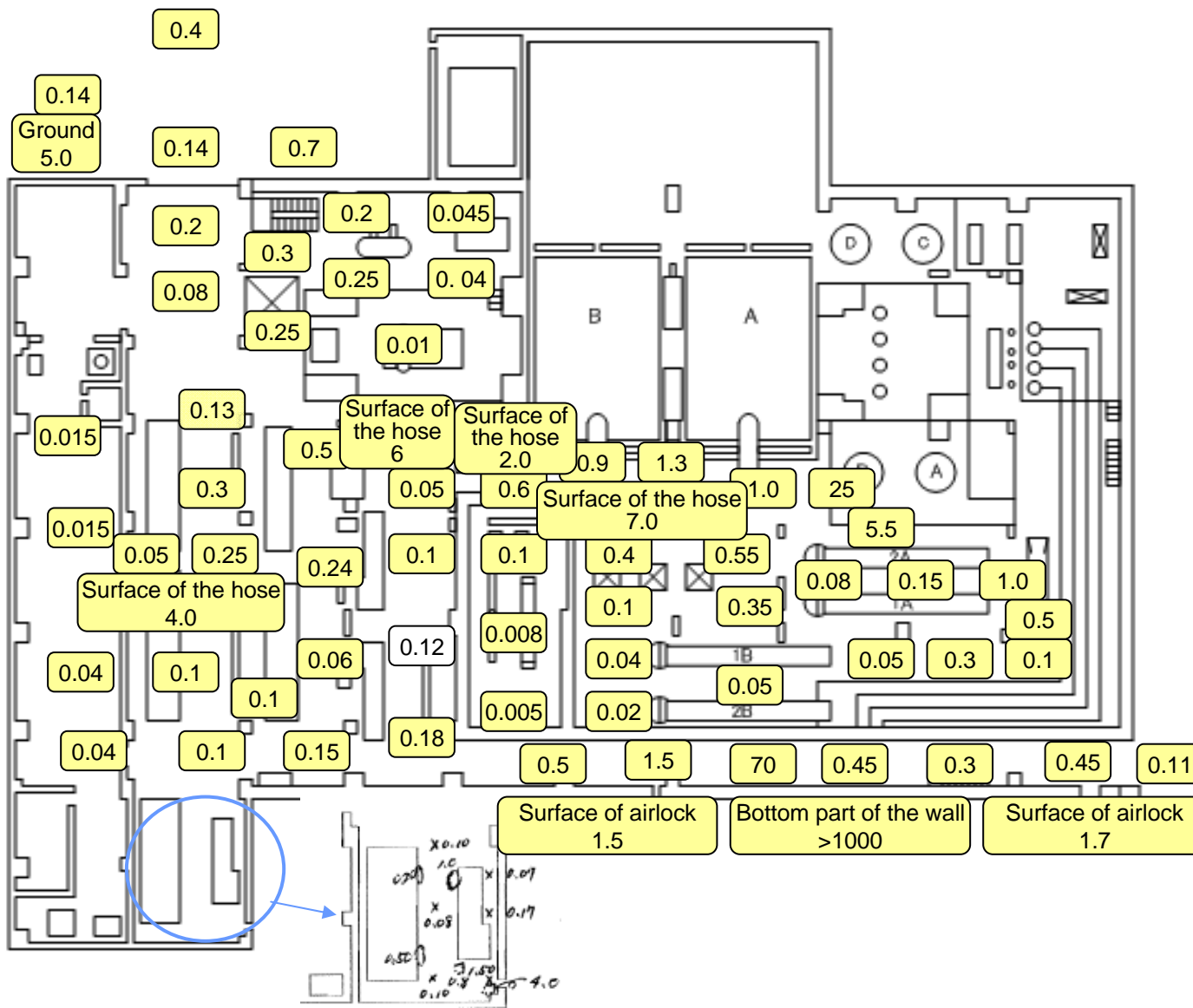

Unit: mSv/h

Unit 1 Turbine Building 1F

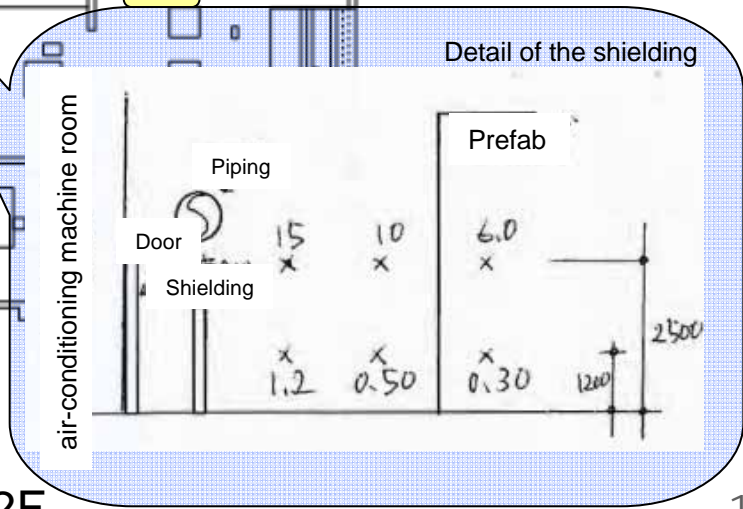
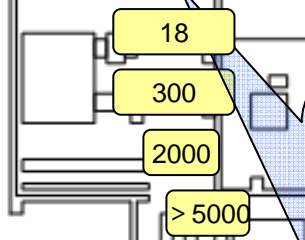
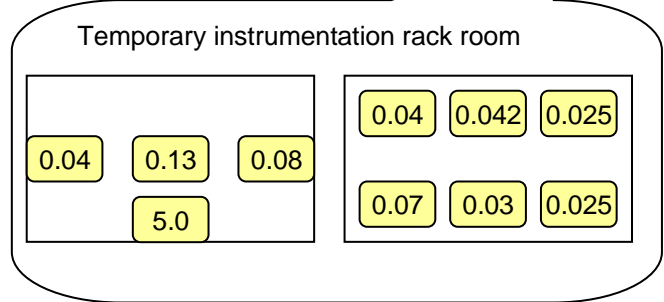
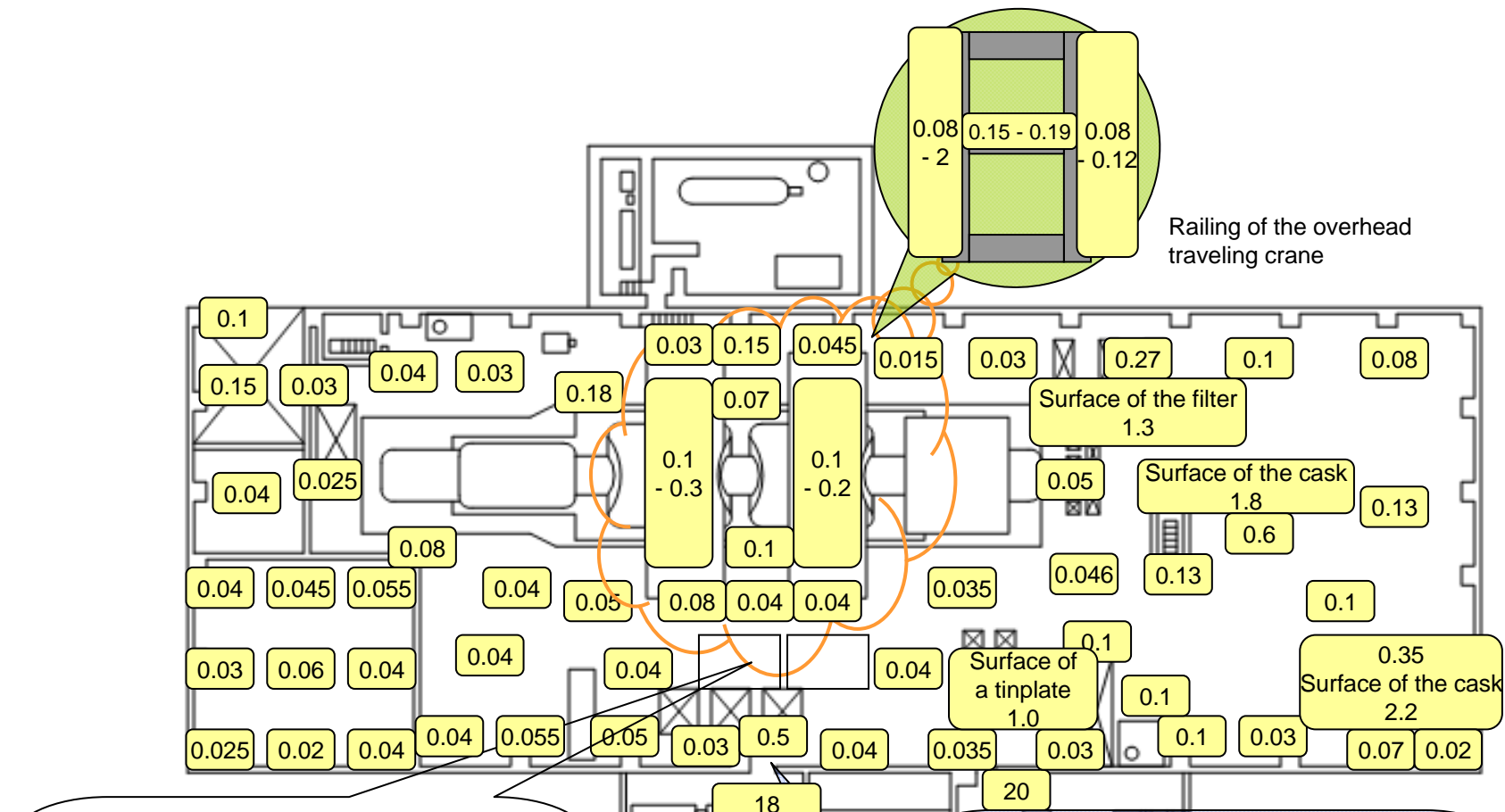

Unit: mSv/h

Unit 1 Turbine Building 2F

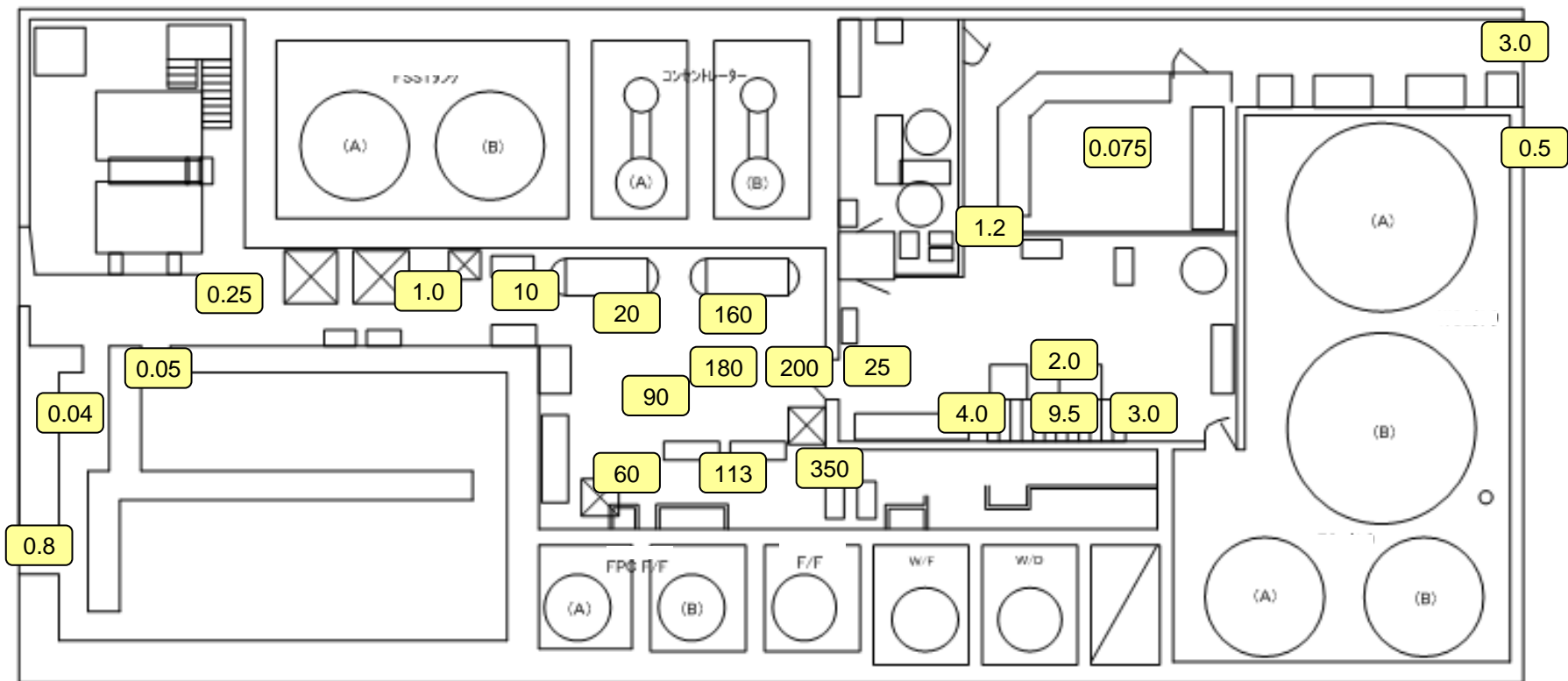

Unit: mSv/h

Unit 1 Waste Treatment Building 1F

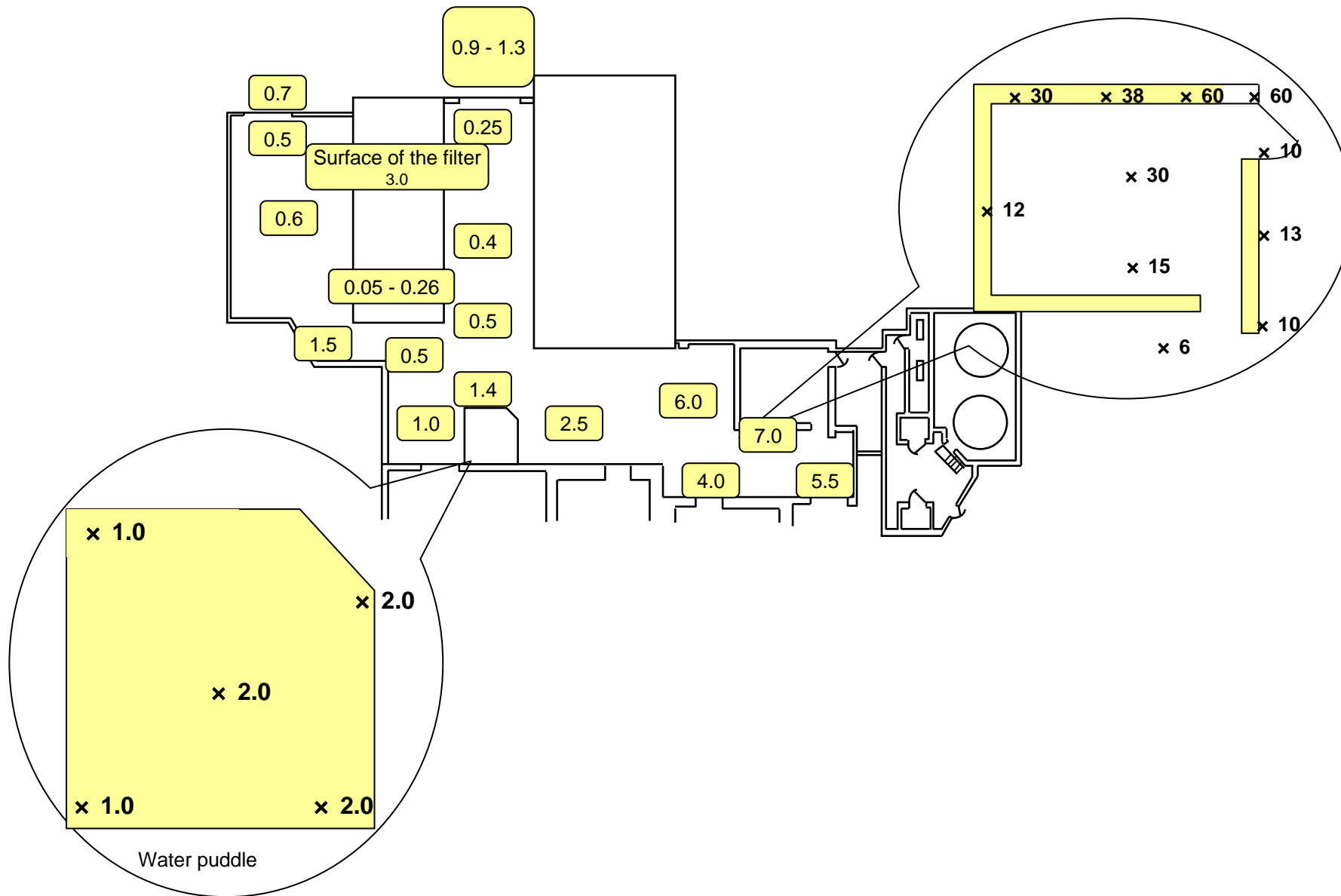

Unit: mSv/h

Unit 1 Waste Treatment Building Oil Drum Carry Out Gate

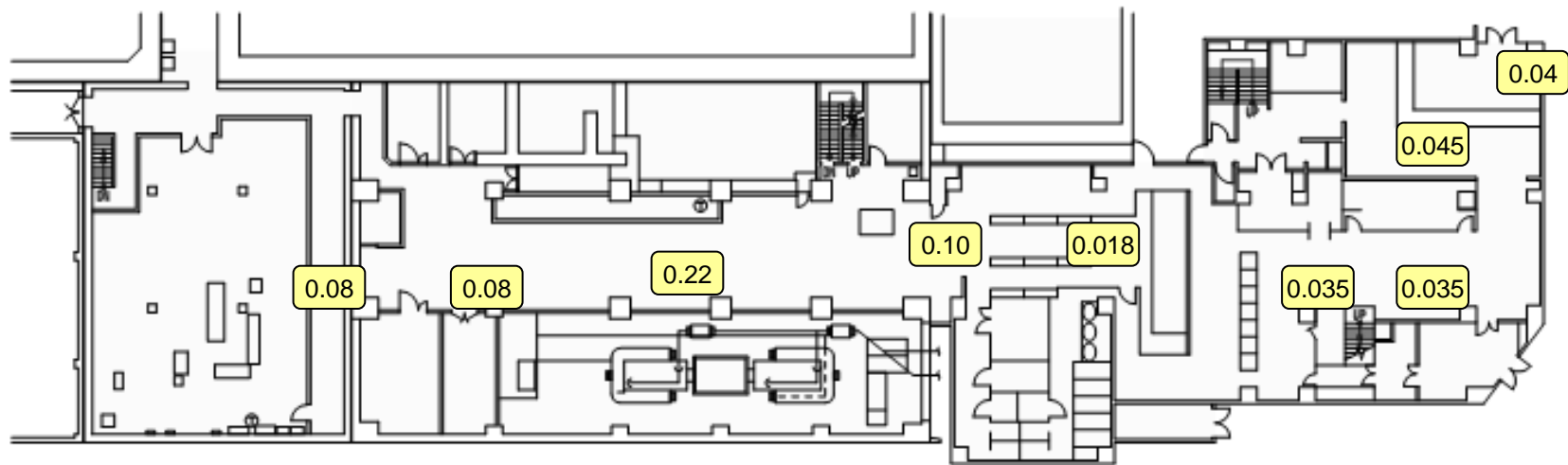

Unit: mSv/h

Unit 1, 2 Service Building 1F

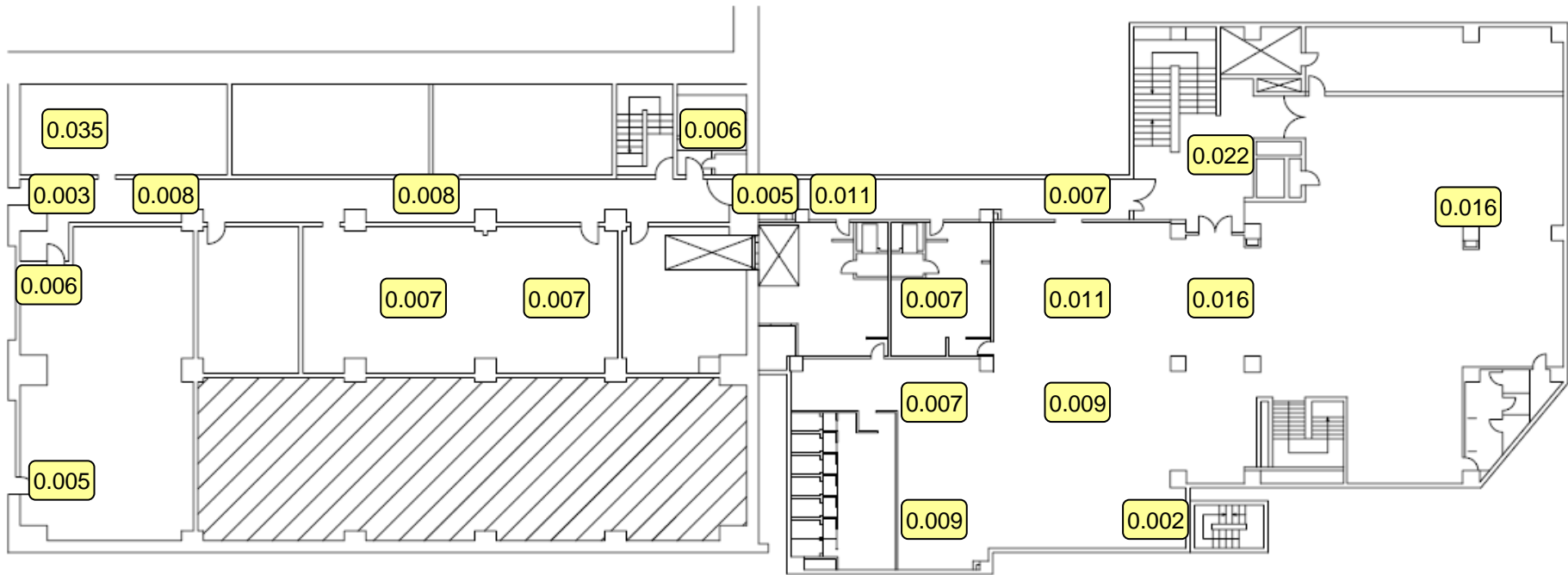

Unit: mSv/h

Unit 1, 2 Service Building 2F

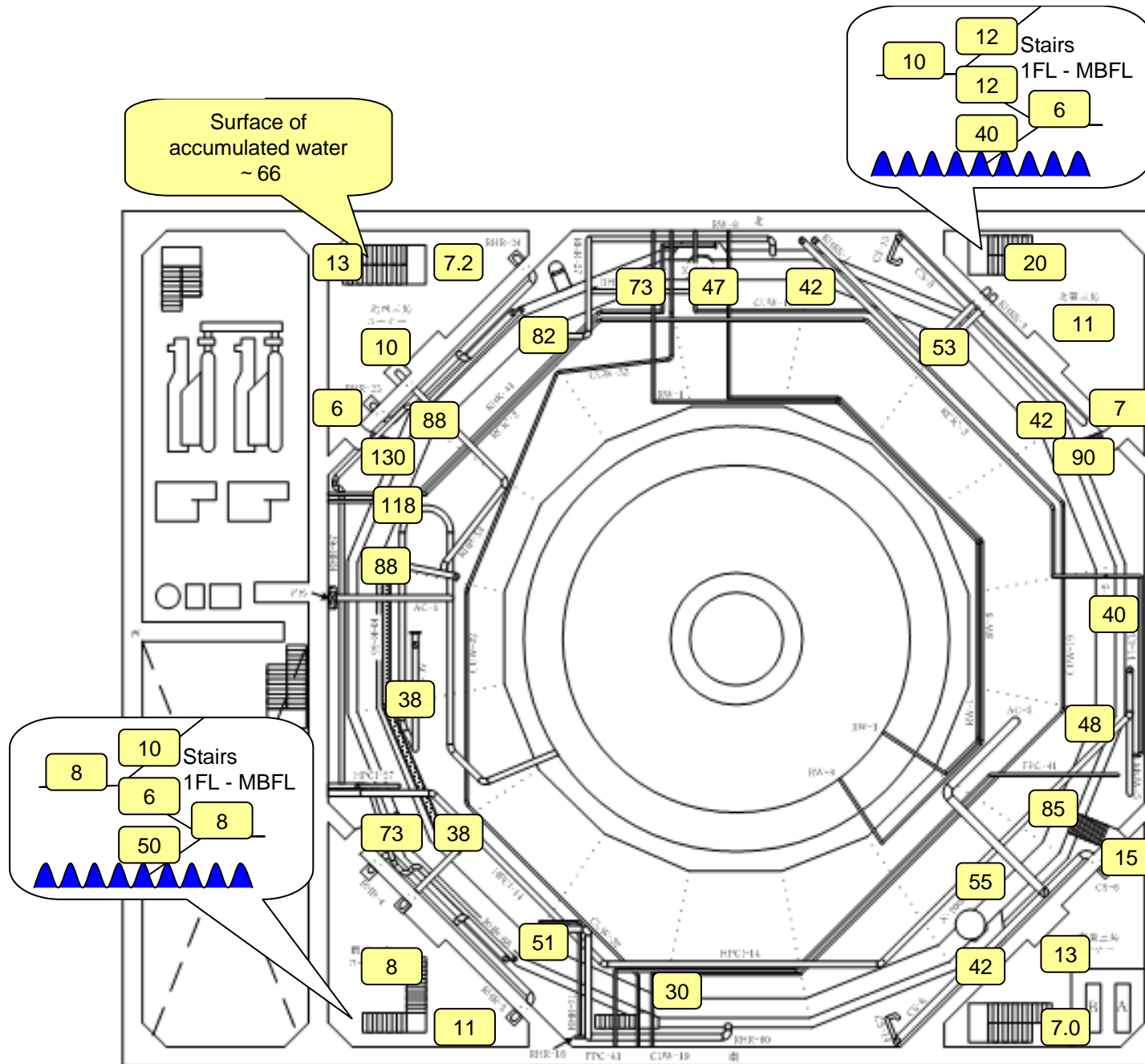

Unit: mSv/h

Unit 2 Reactor Building MB1F

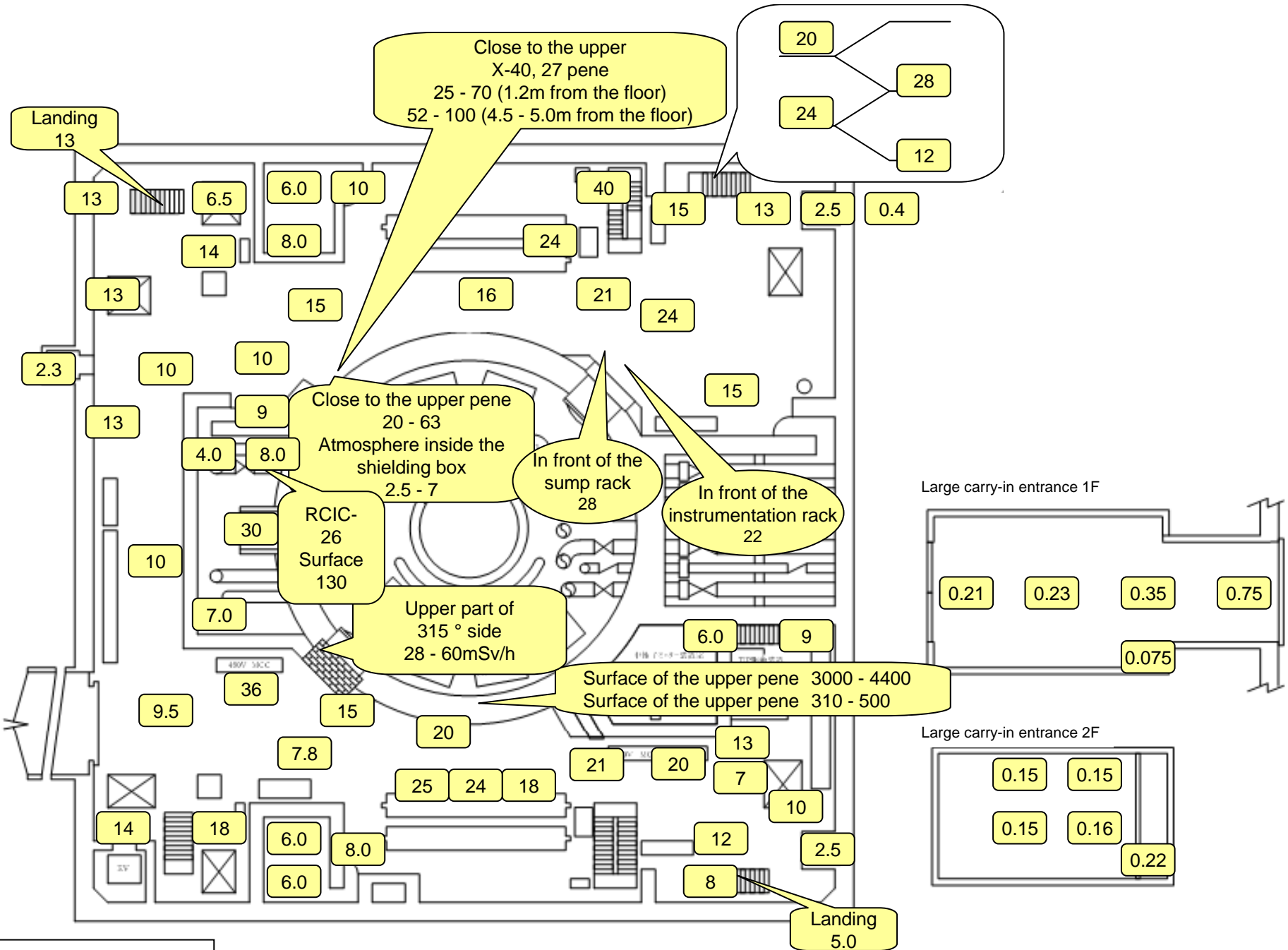

Unit 2 Reactor Building 1F

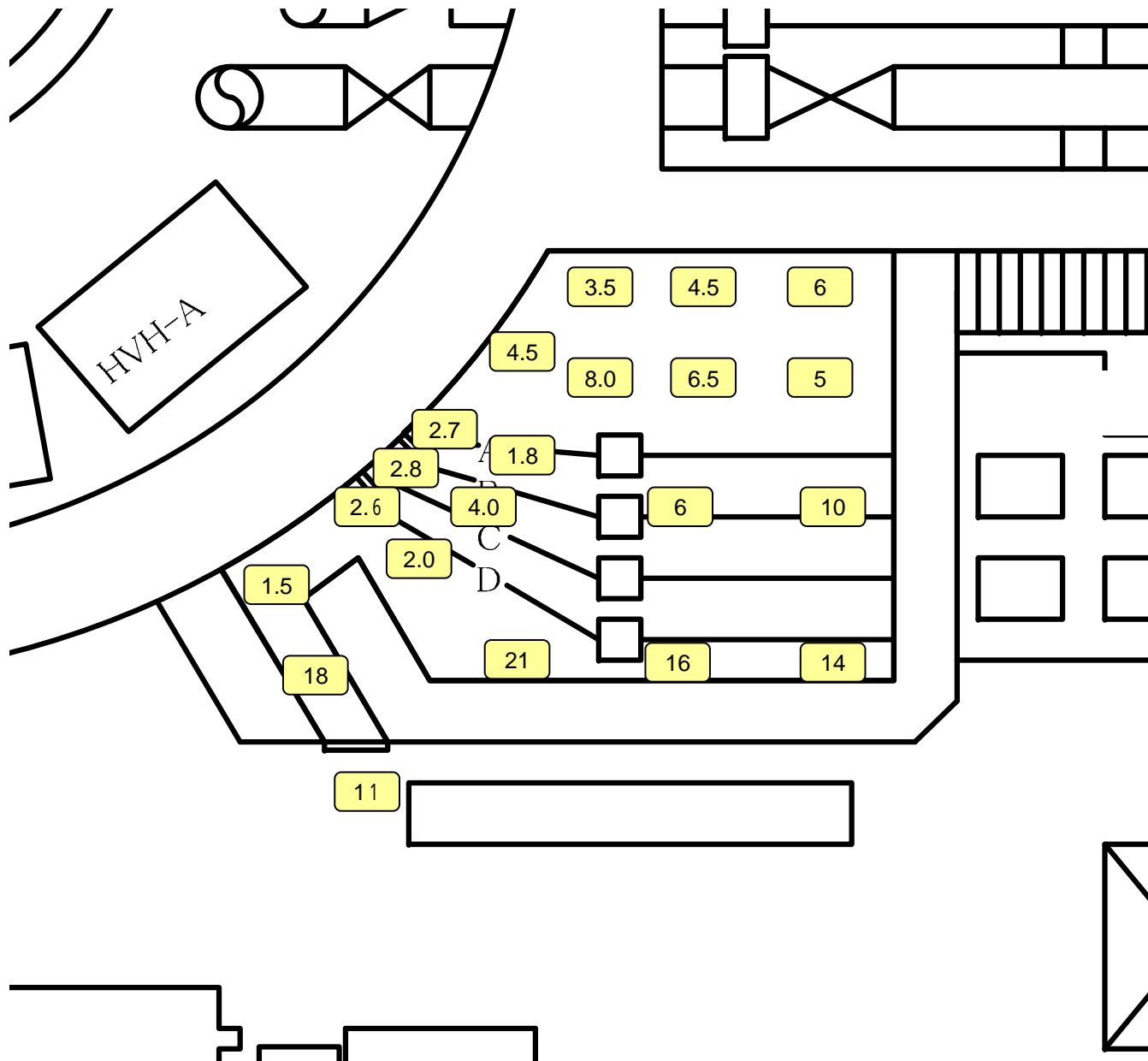

Unit: mSv/h

Unit 2 Reactor Building 1F Southeast Side (Inside the TIP Room)

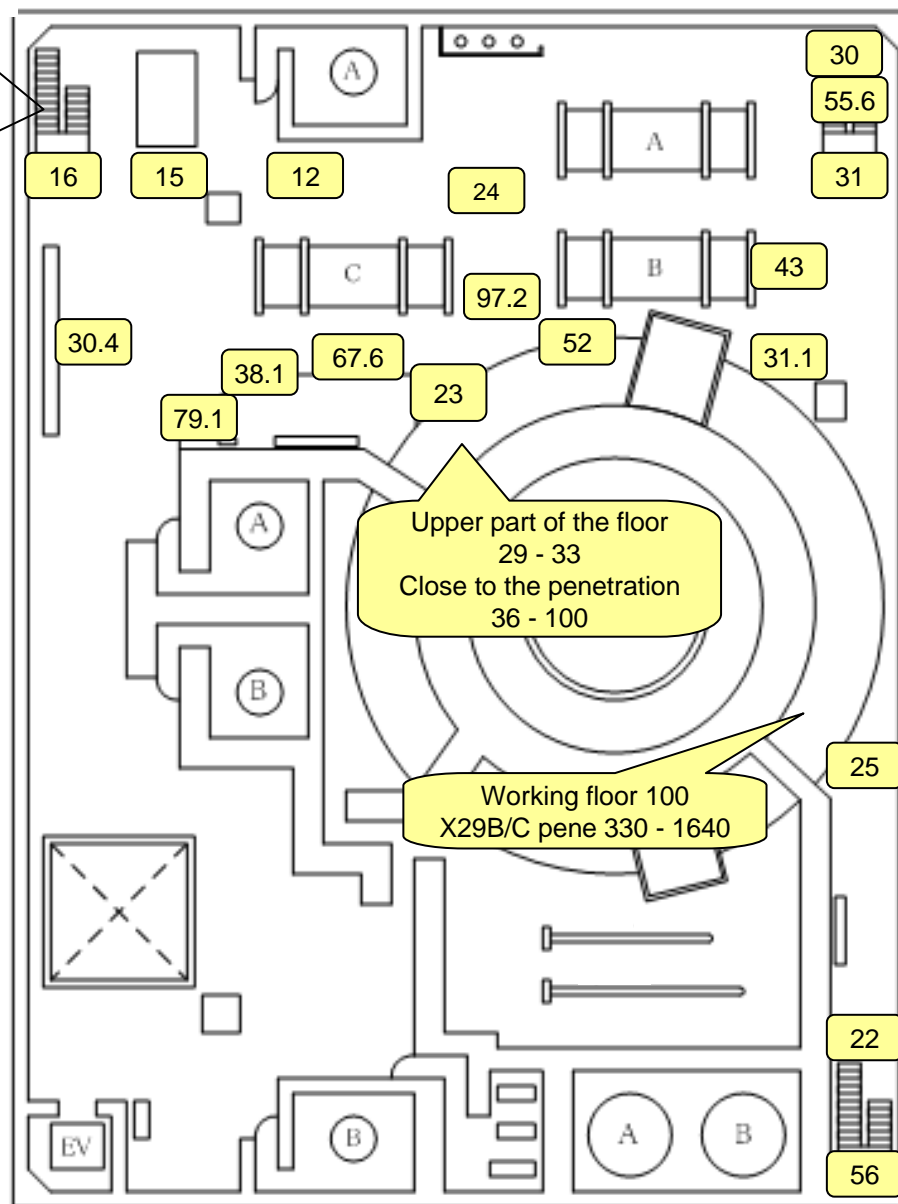
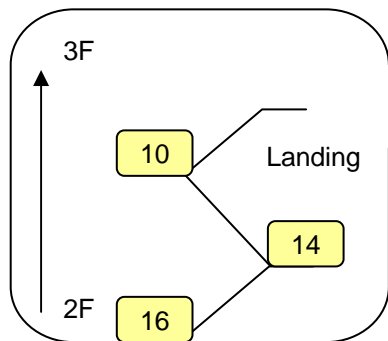

Unit: mSv/h

Unit 2 Reactor Building 2F

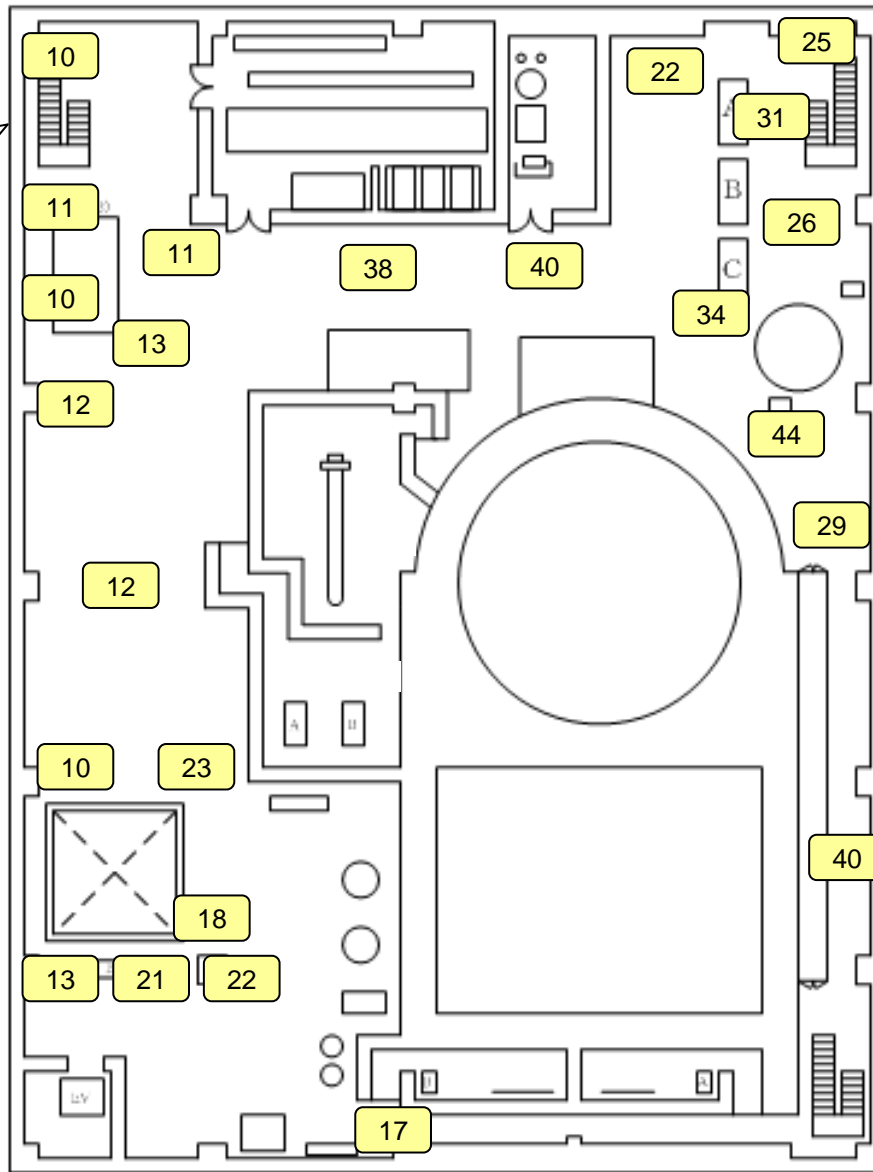
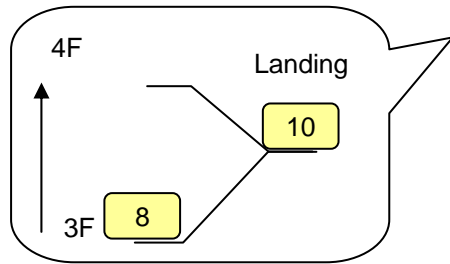

Unit: mSv/h

Unit 2 Reactor Building 3F

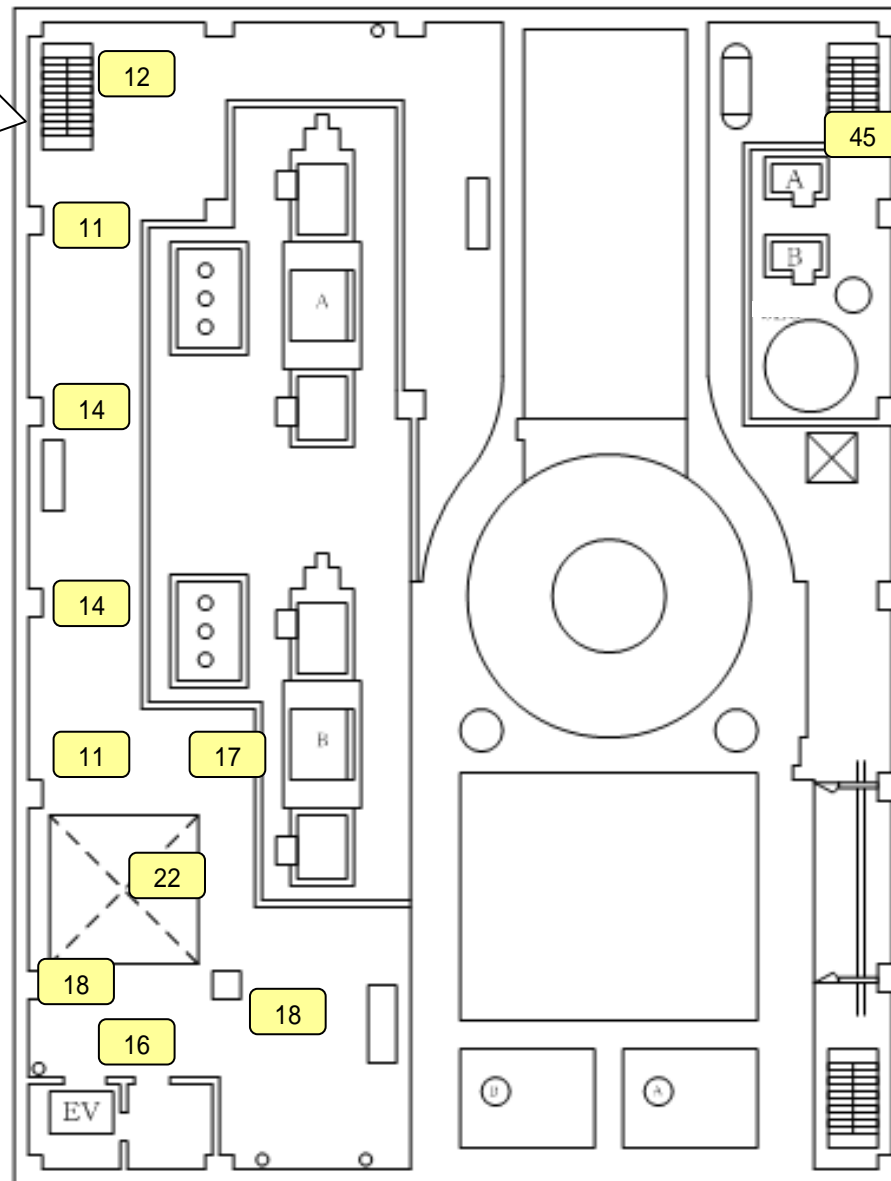
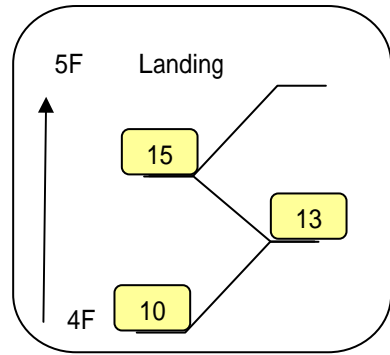

Unit: mSv/h

Unit 2 Reactor Building 4F

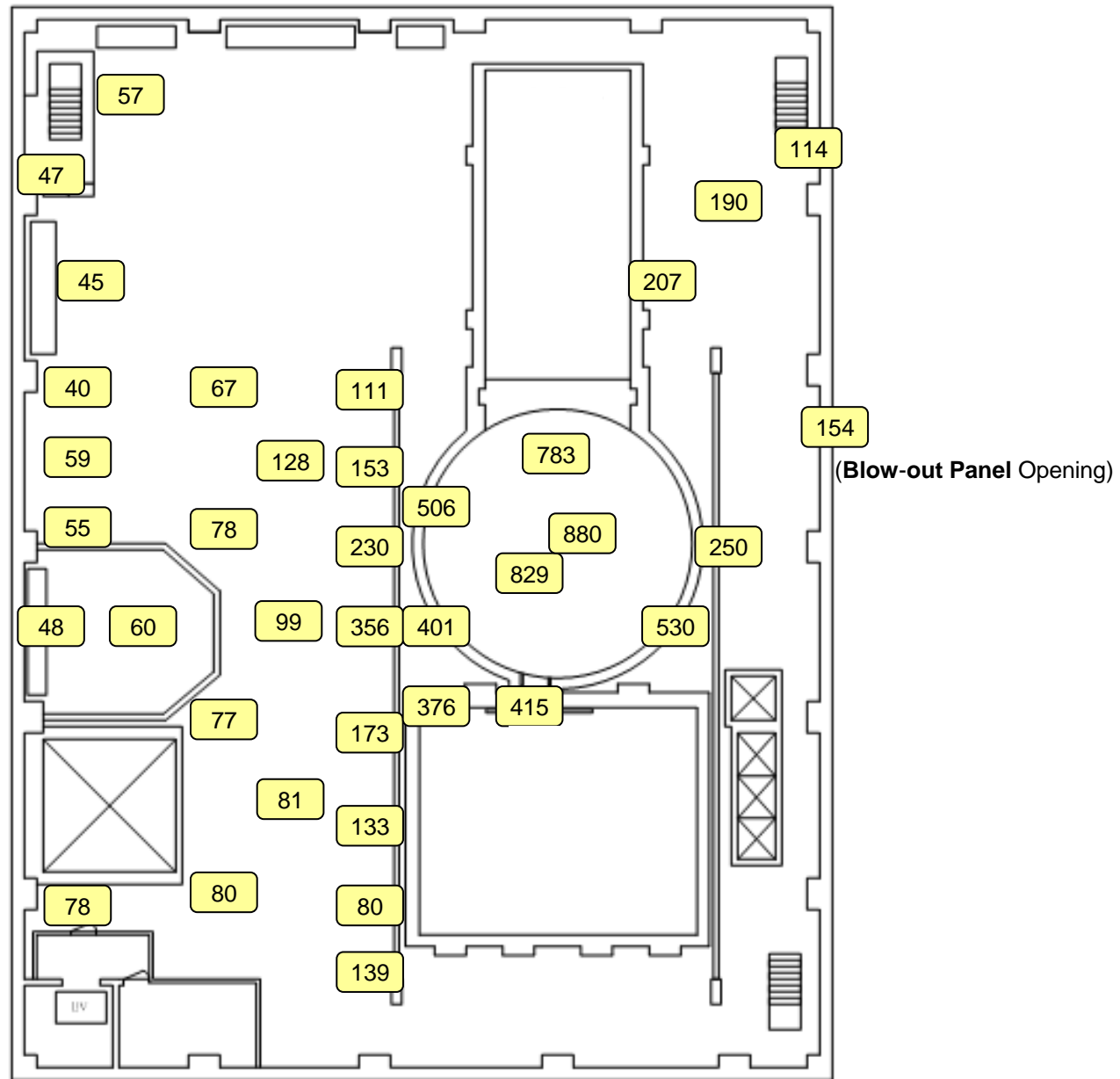

Unit: mSv/h

Unit 2 Reactor Building 5F

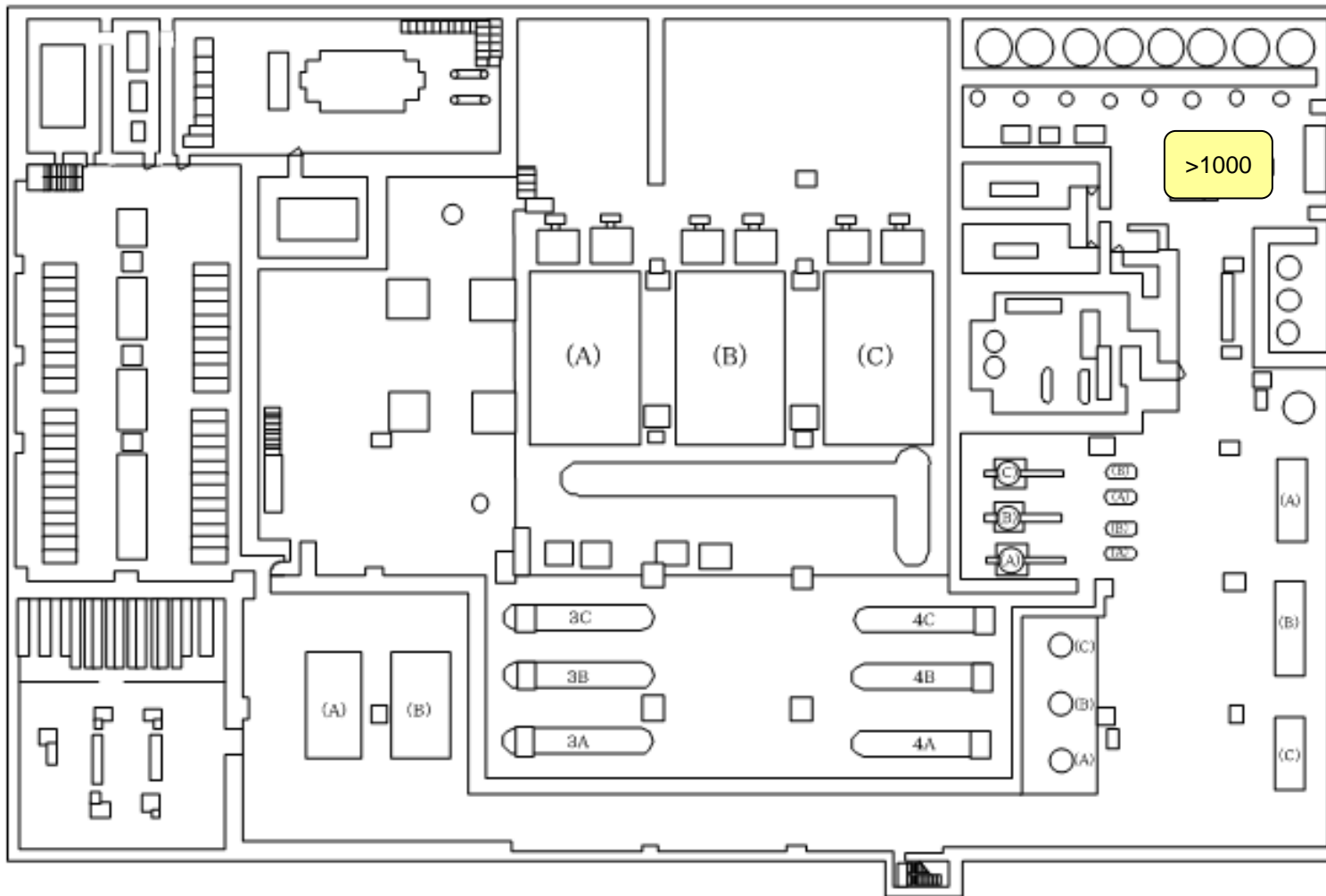

Unit 2 Turbine Building B1F

Unit: mSv/h

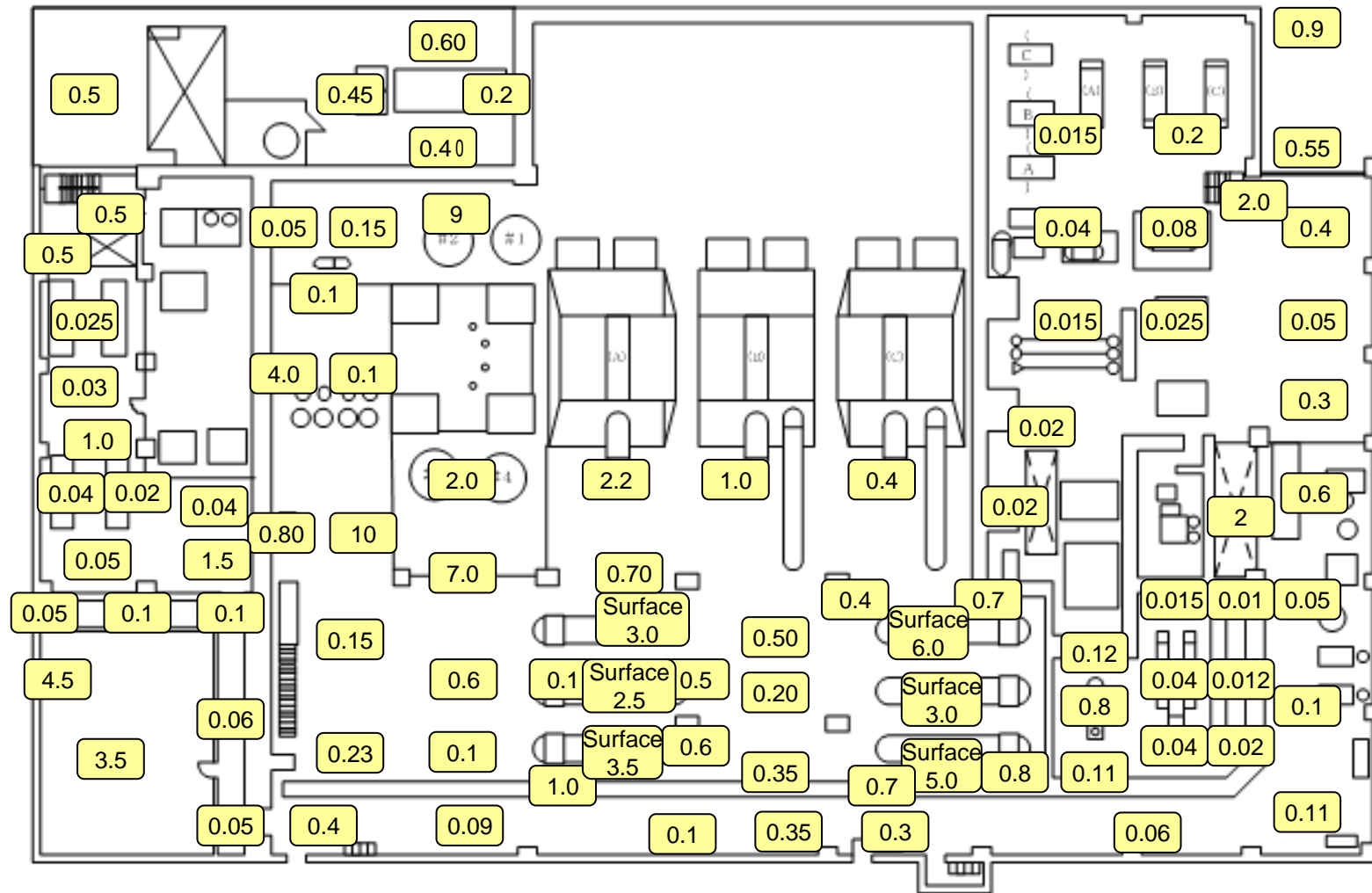

Unit 2 Turbine Building 1F

Unit: mSv/h

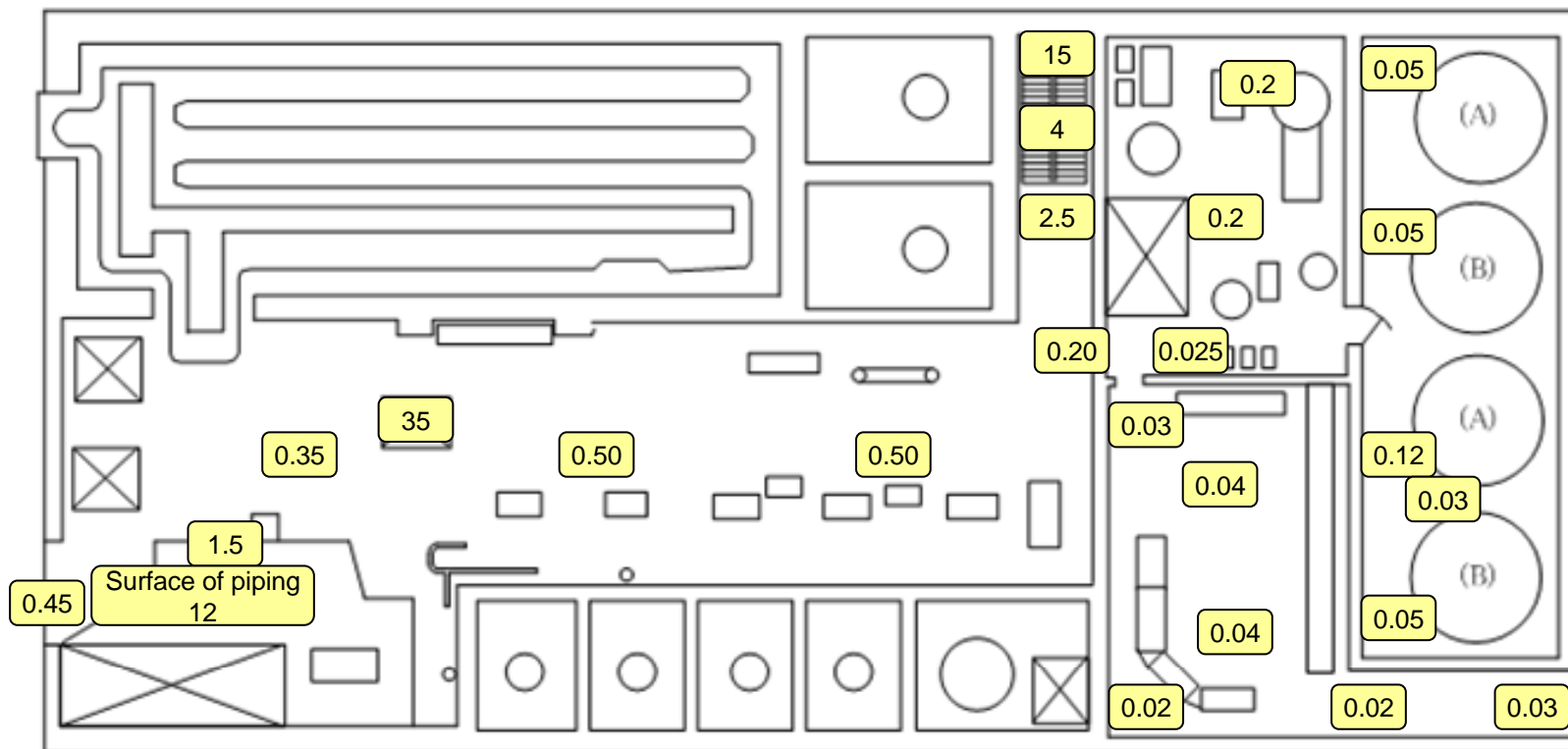

Unit 2 Waste Treatment Building 1F

Unit: mSv/h

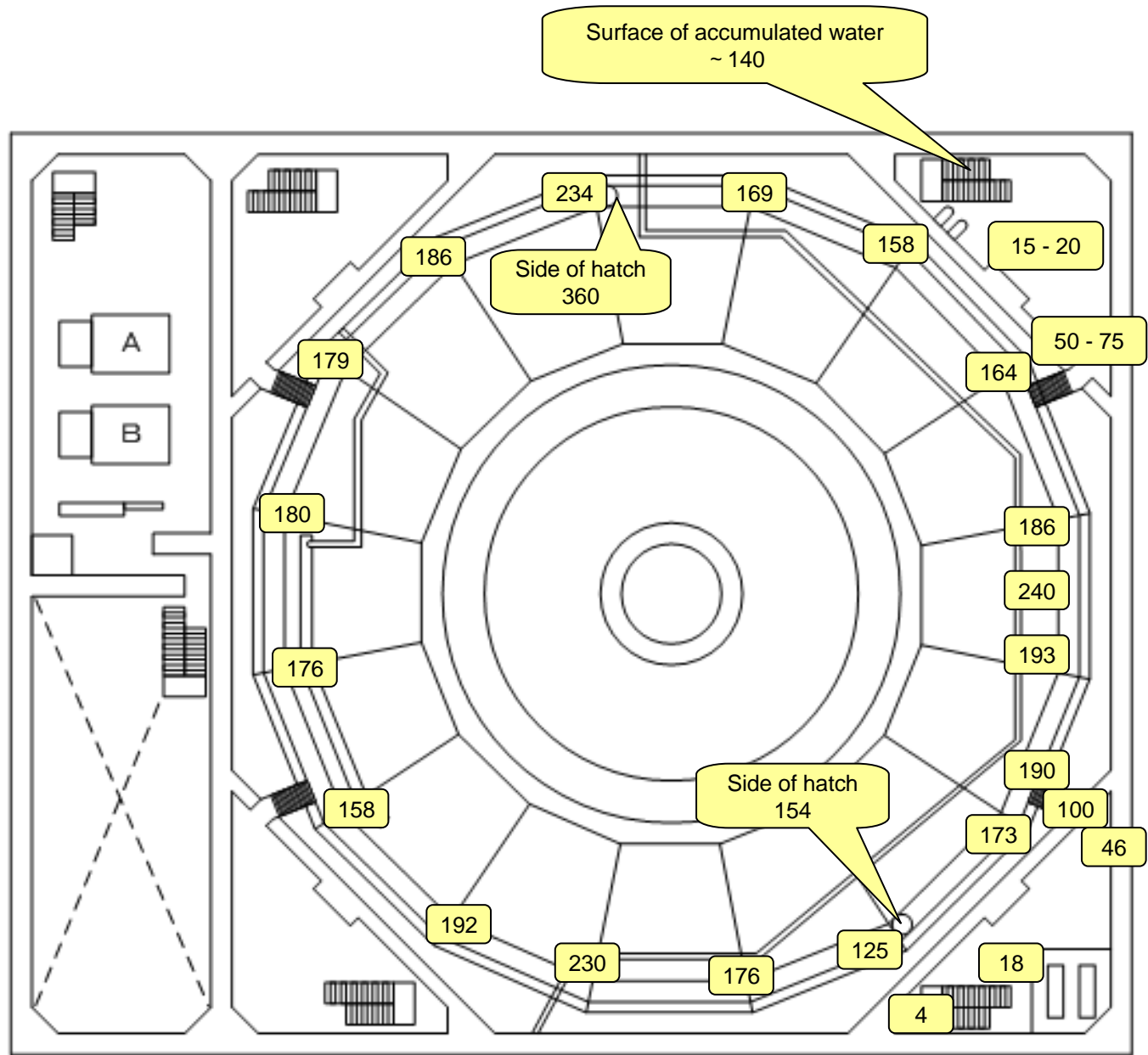

Unit: mSv/h

Unit 2 Waste Treatment Building MB1F

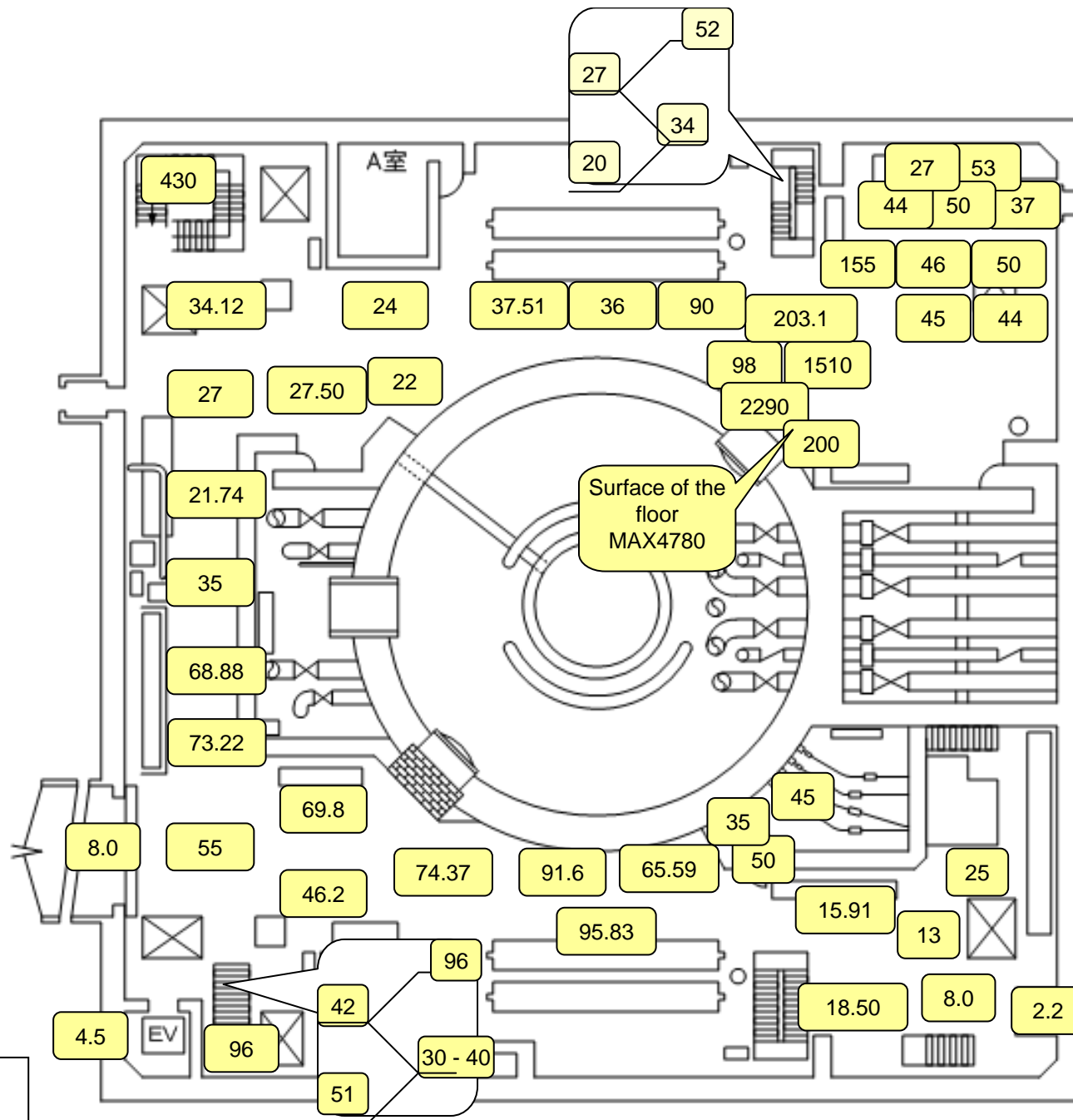

Unit: mSv/h

Unit 3 Reactor Building 1F

Unit: mSv/h

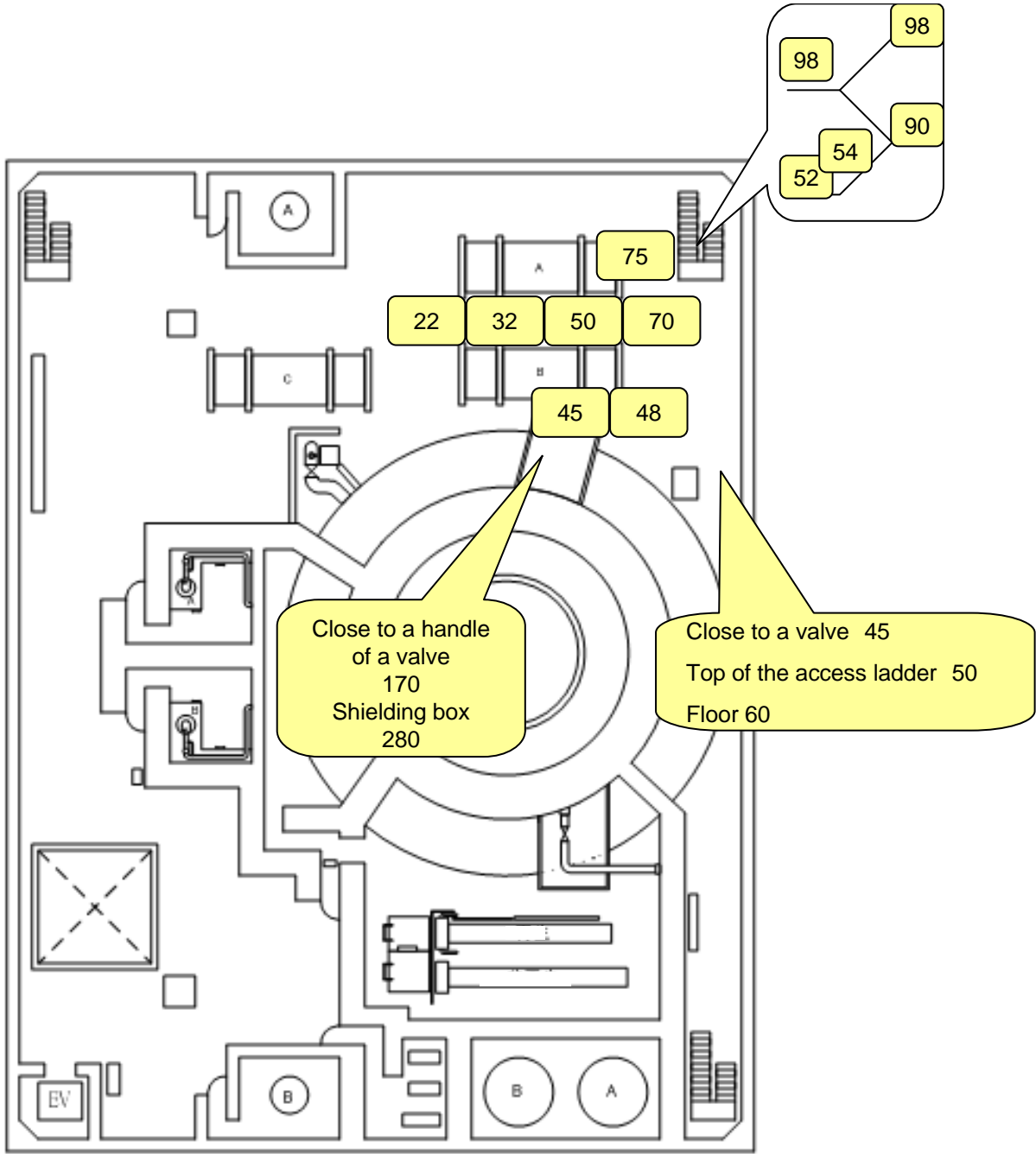

Unit 3 Reactor Building 2F

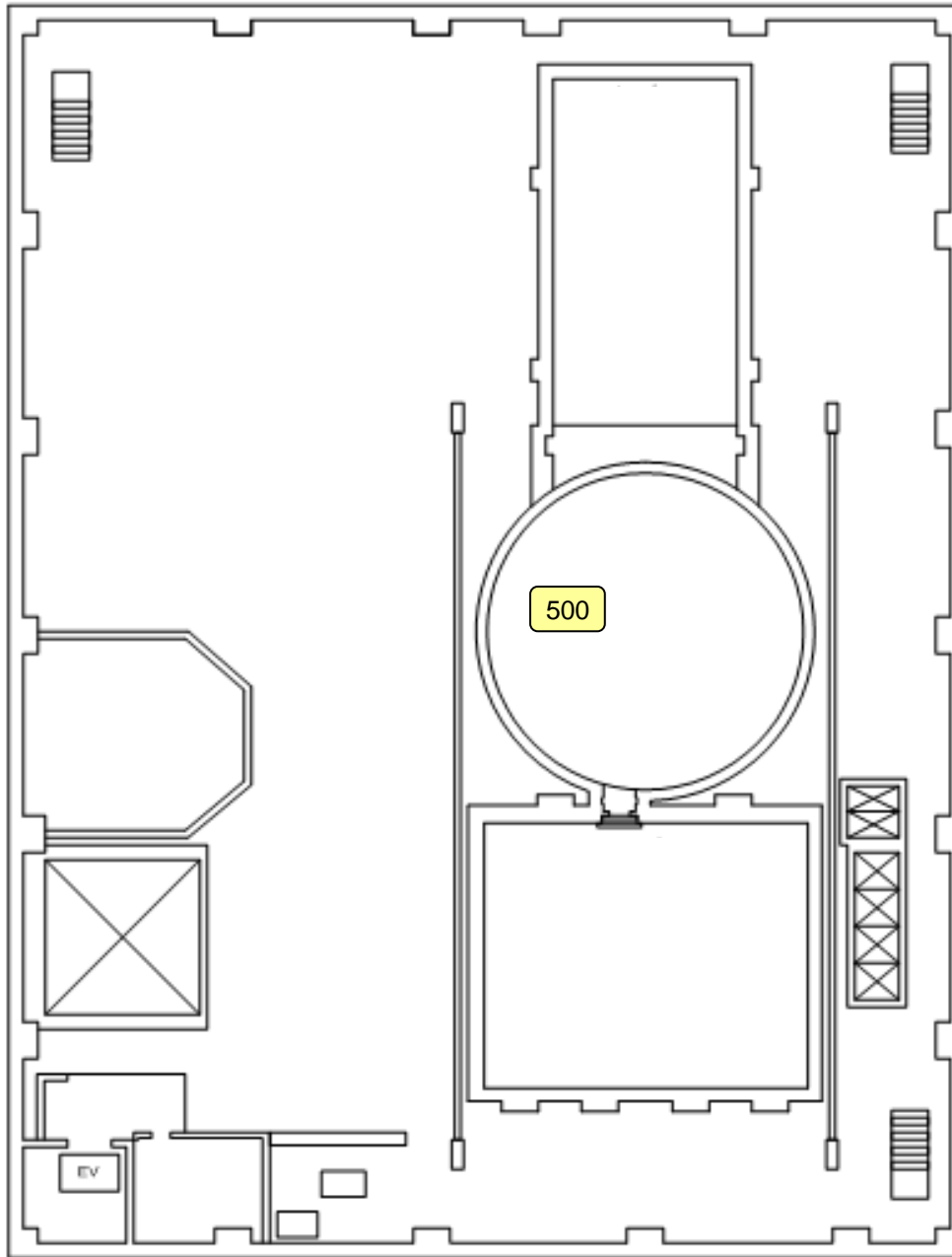

Unit: mSv/h

Unit 3 Reactor Building 5F

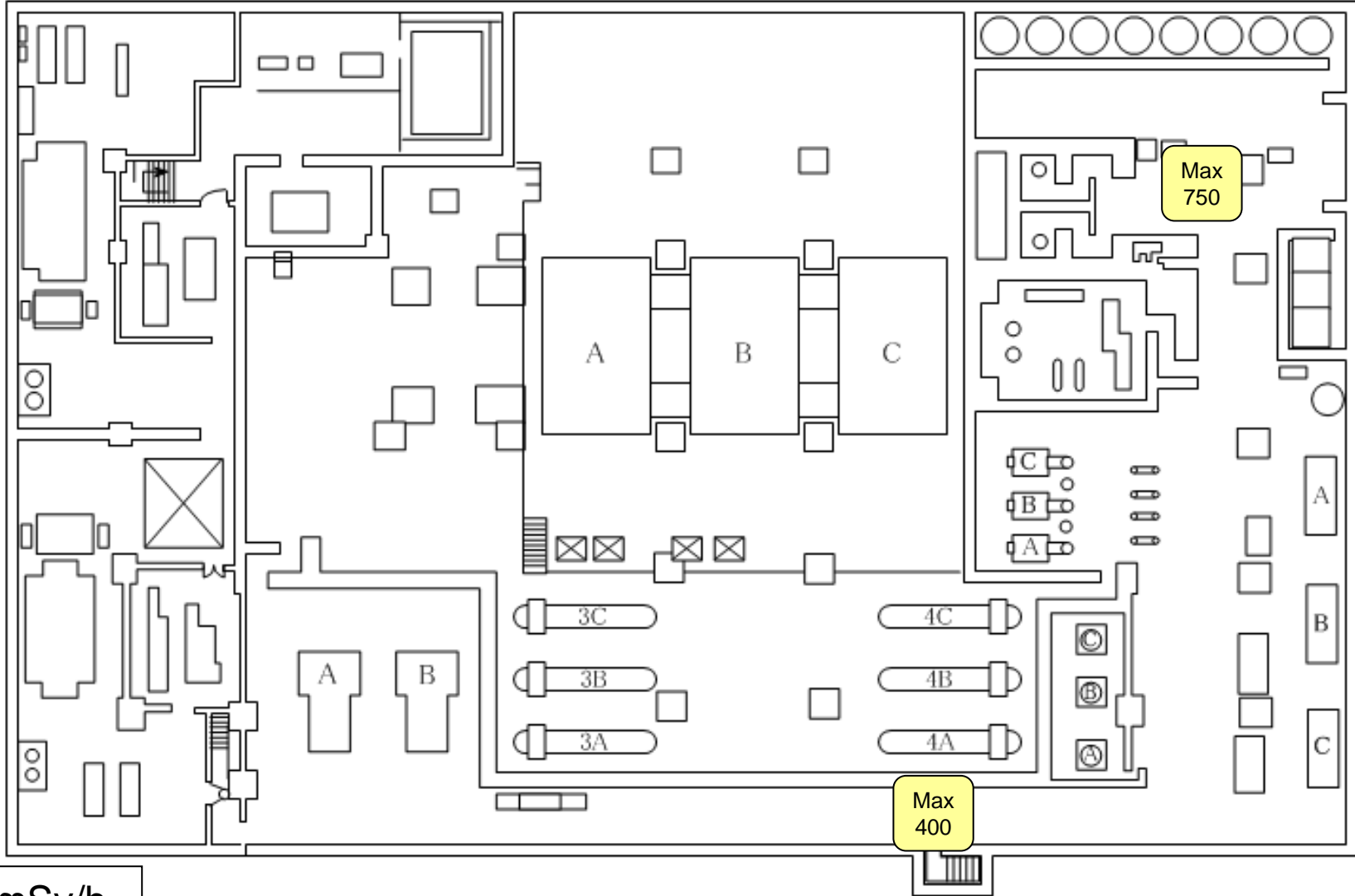

Unit: mSv/h

Unit 3 Turbine Building B1F

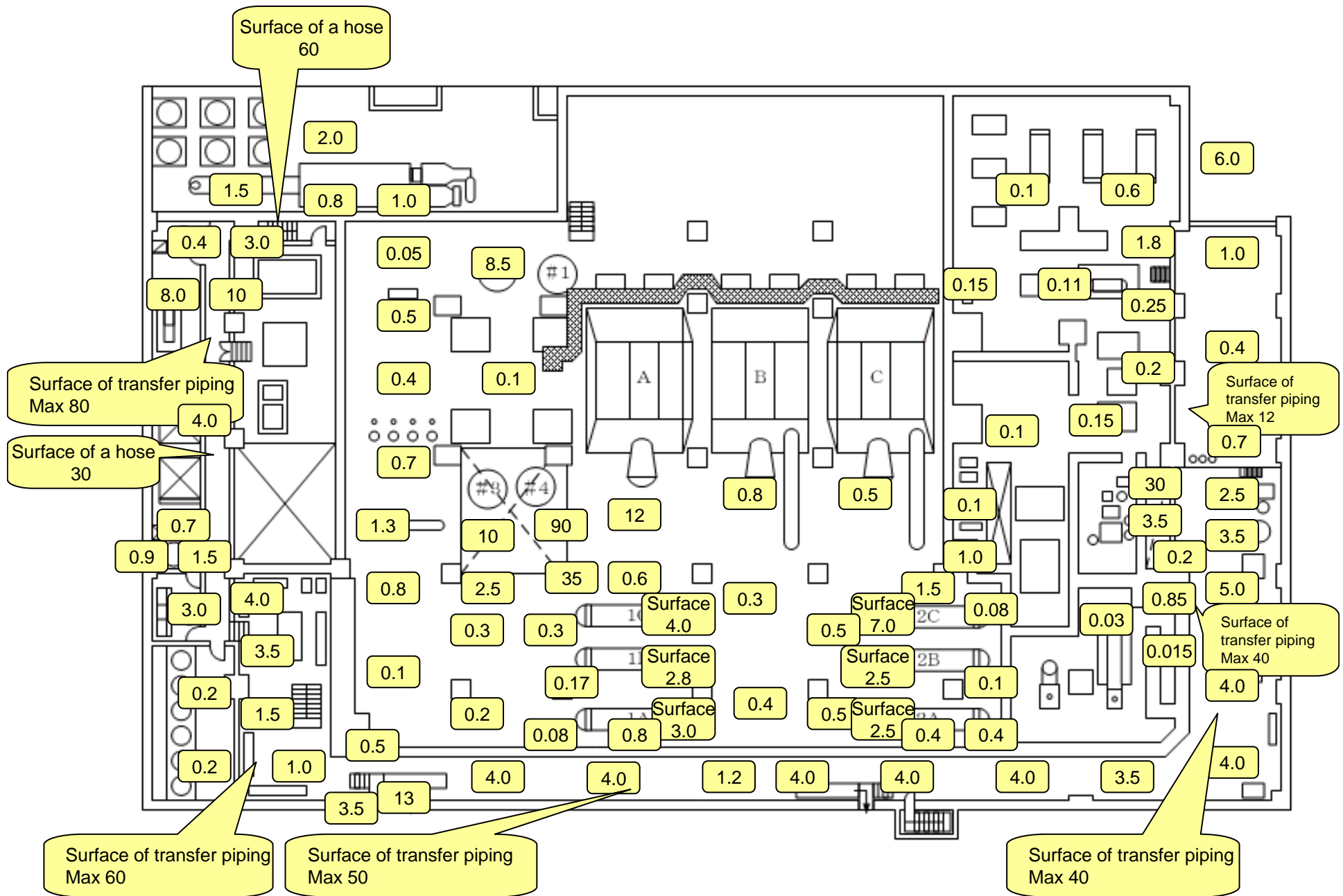

Unit: mSv/h

Unit 3 Turbine Building 1F

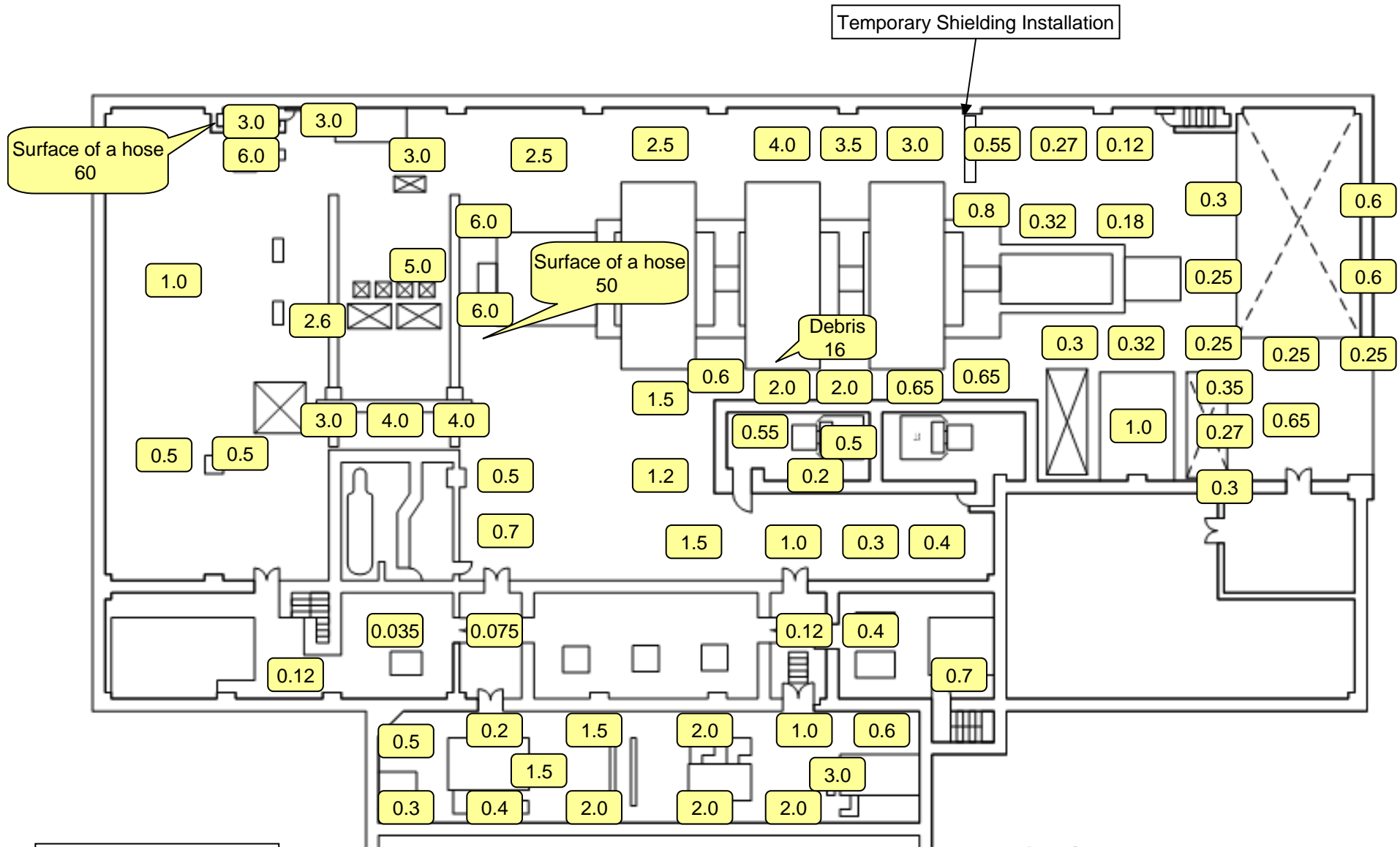

Unit: mSv/h

Unit 3 Turbine Building 2F

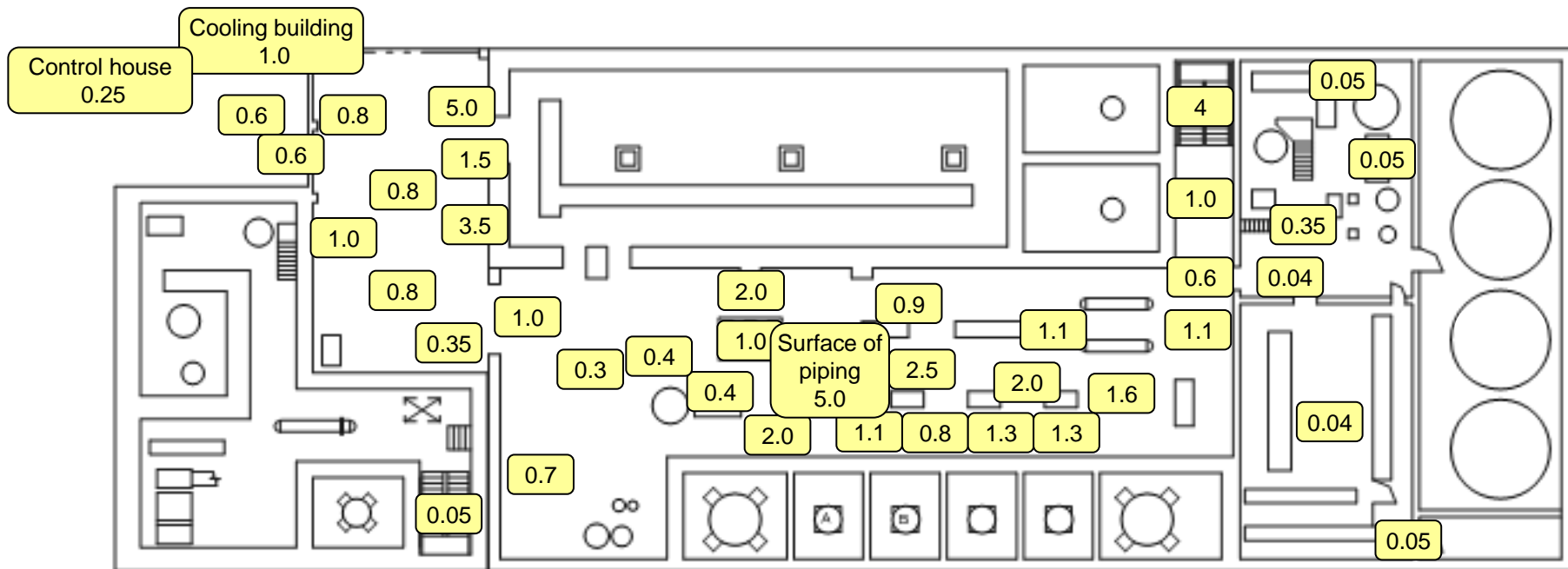

Unit: mSv/h

Unit 3 Waste Treatment Building 1F

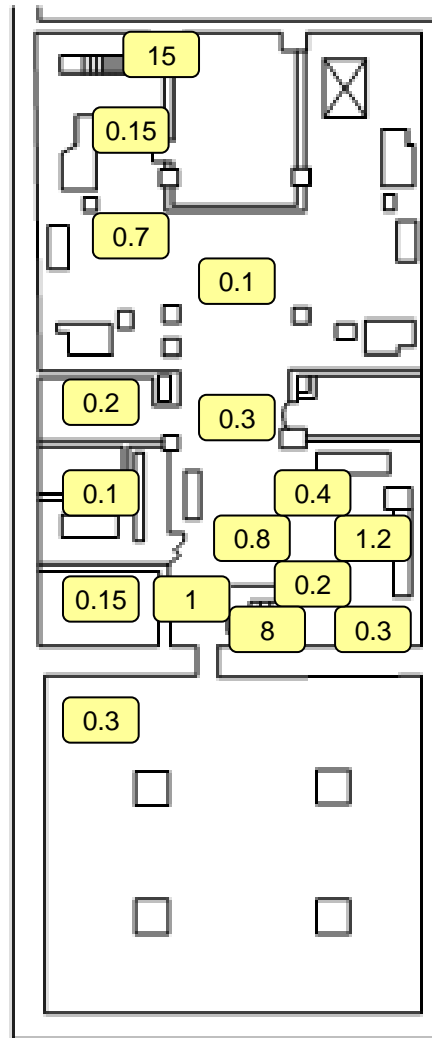

Unit: mSv/h

Unit 3, 4 Service Building MB1F



Unit: mSv/h

Unit 3, 4 Service Building 1F

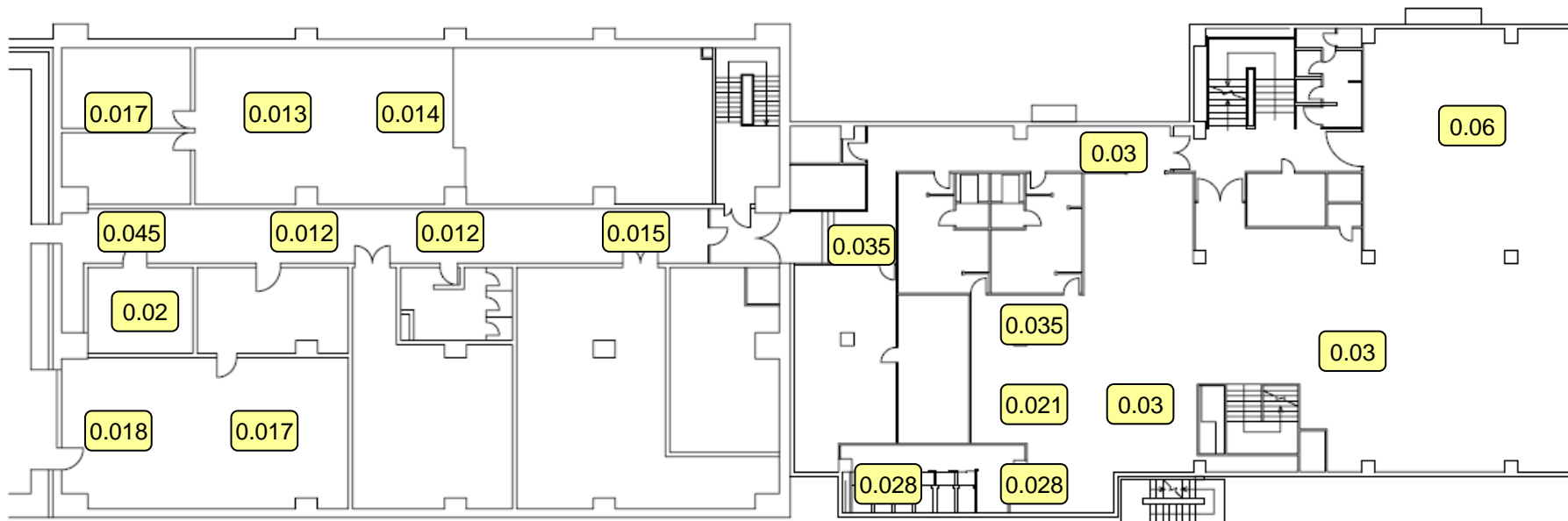

Unit: mSv/h

Unit 3, 4 Service Building 2F

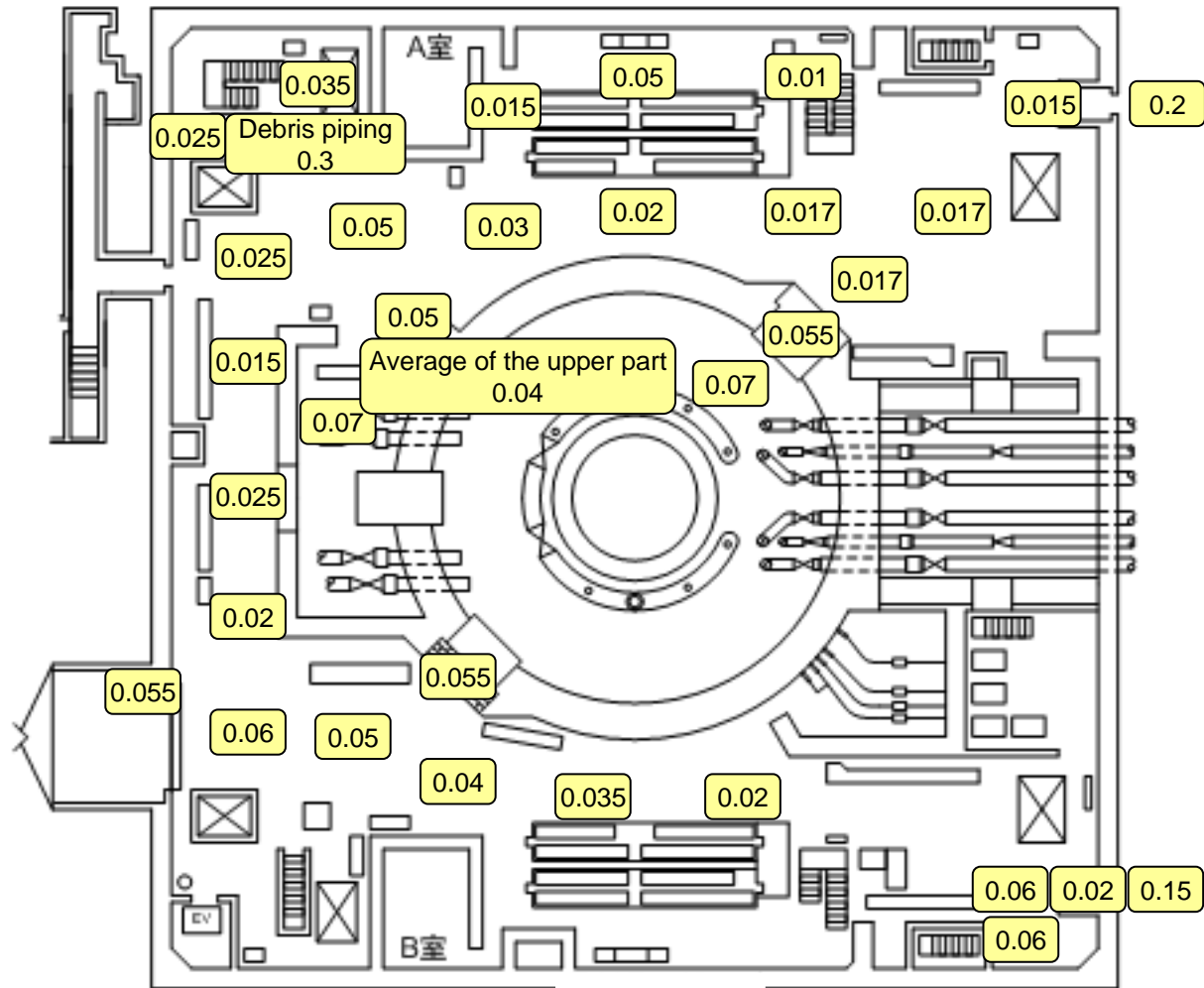

Unit: mSv/h

Unit 4 Reactor Building 1F

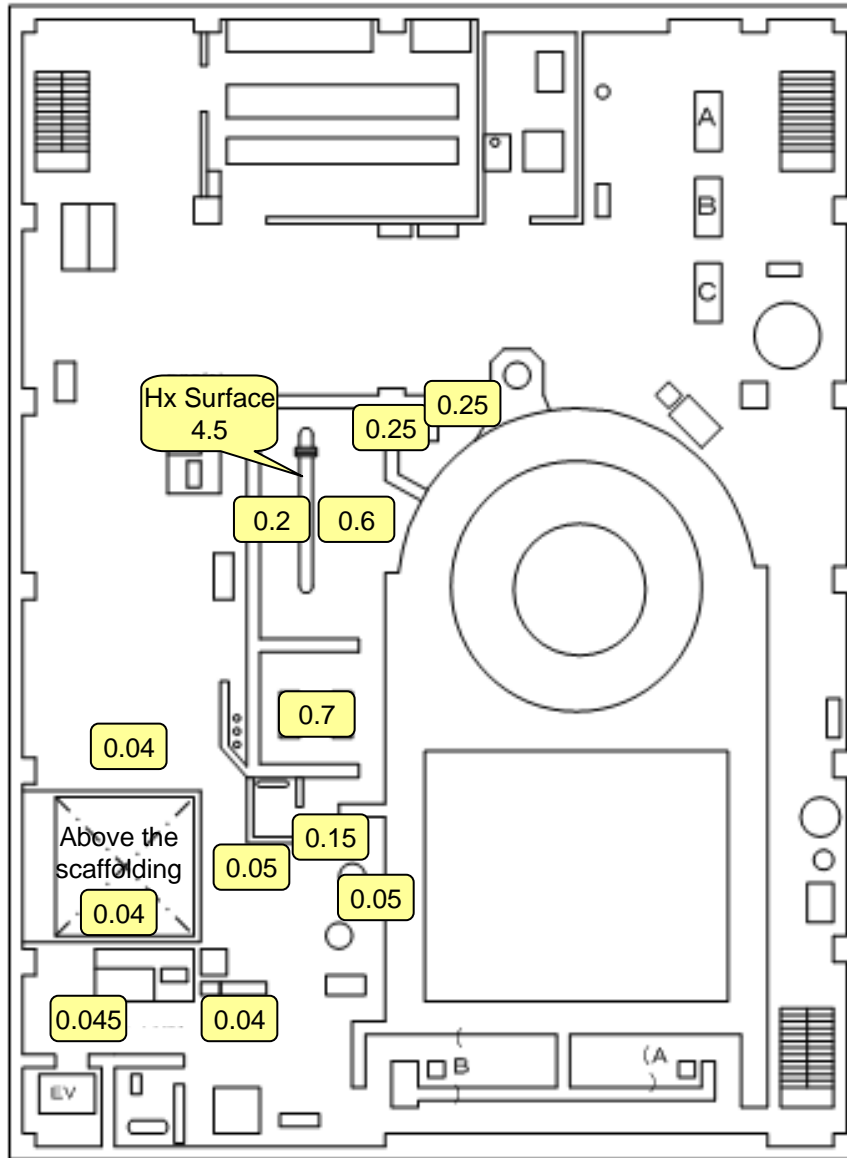

Unit: mSv/h

Unit 4 Reactor Building 3F

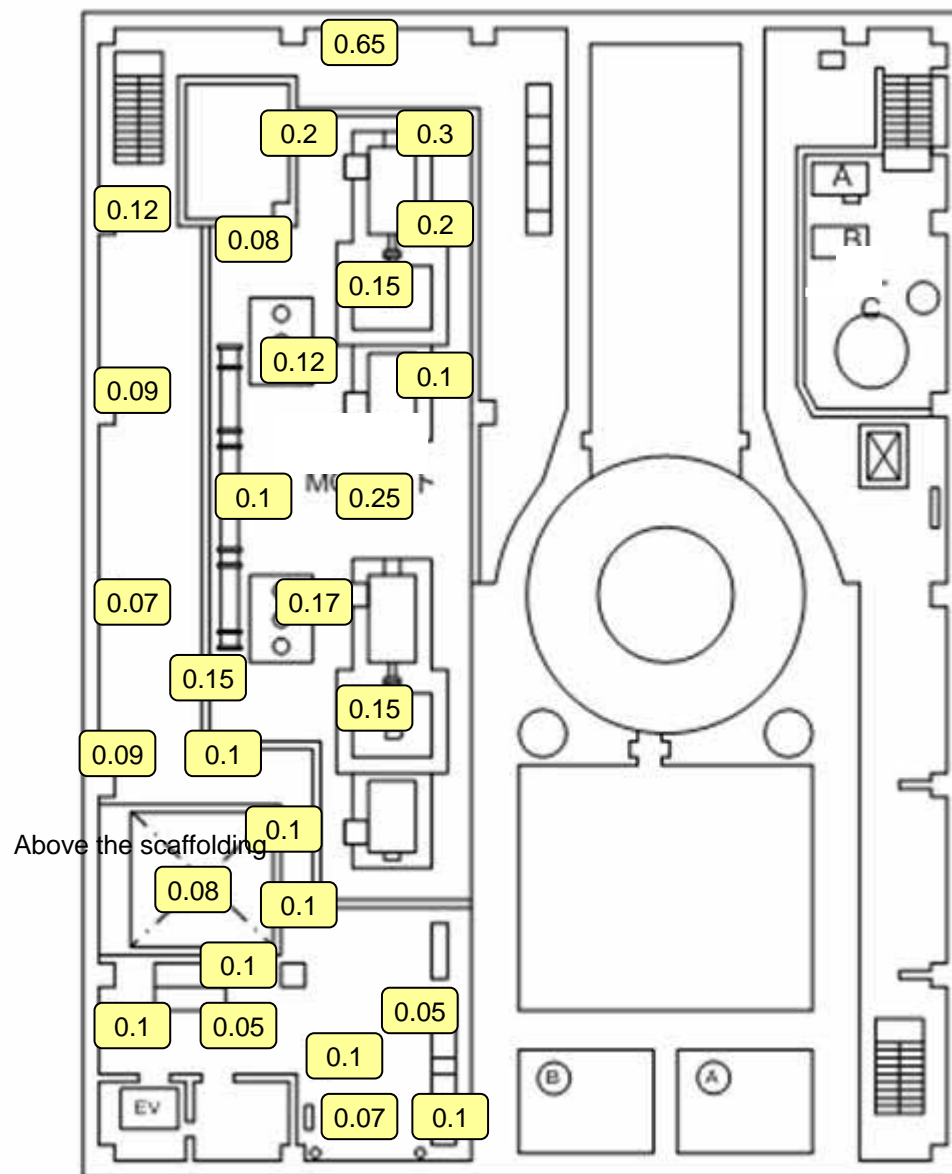

Unit: mSv/h

Unit 4 Reactor Building 4F

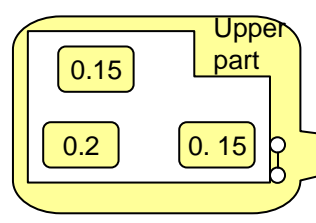
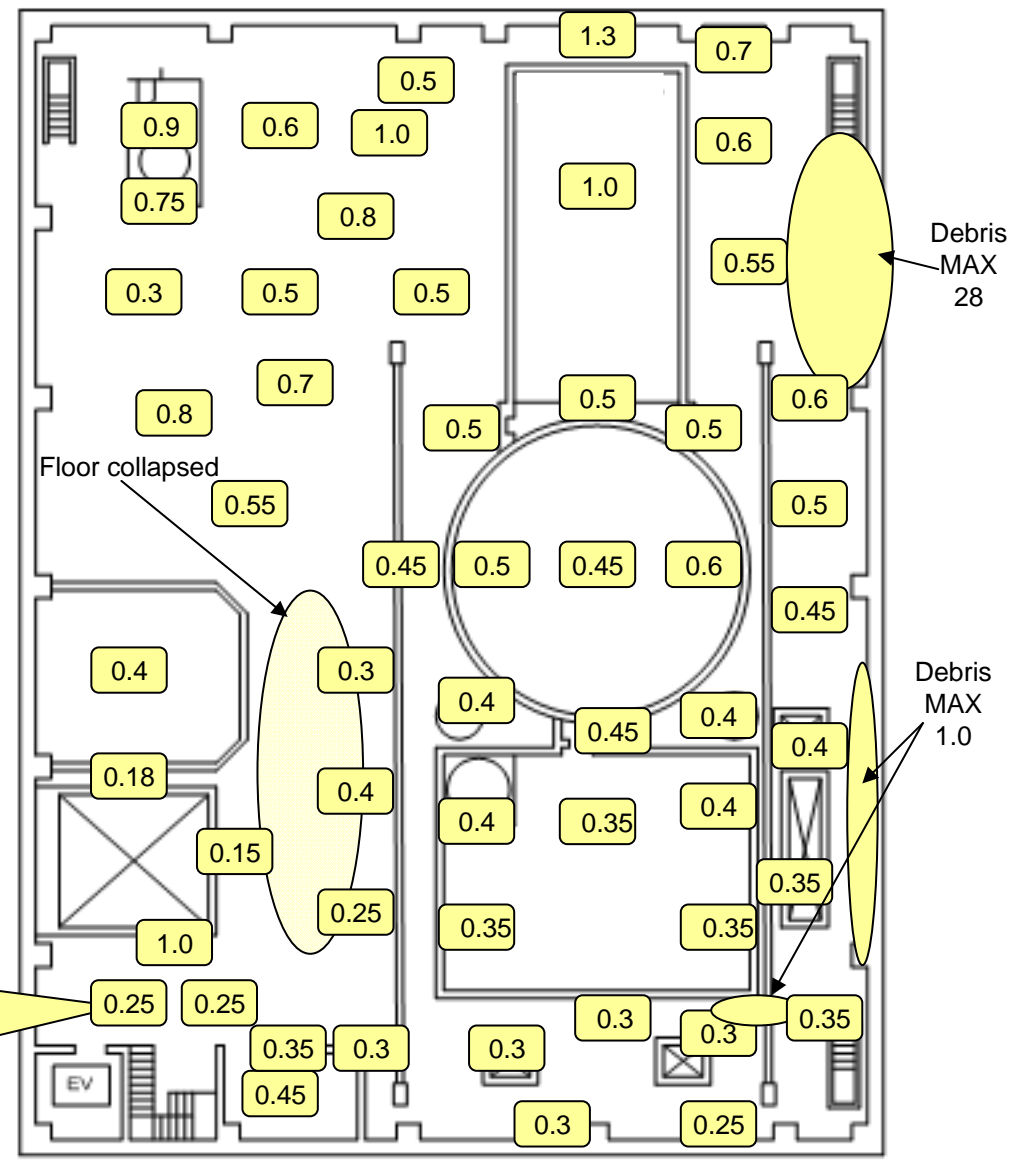
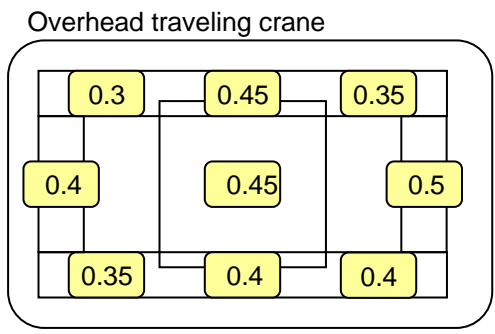

Unit: mSv/h

Unit 4 Reactor Building 5F

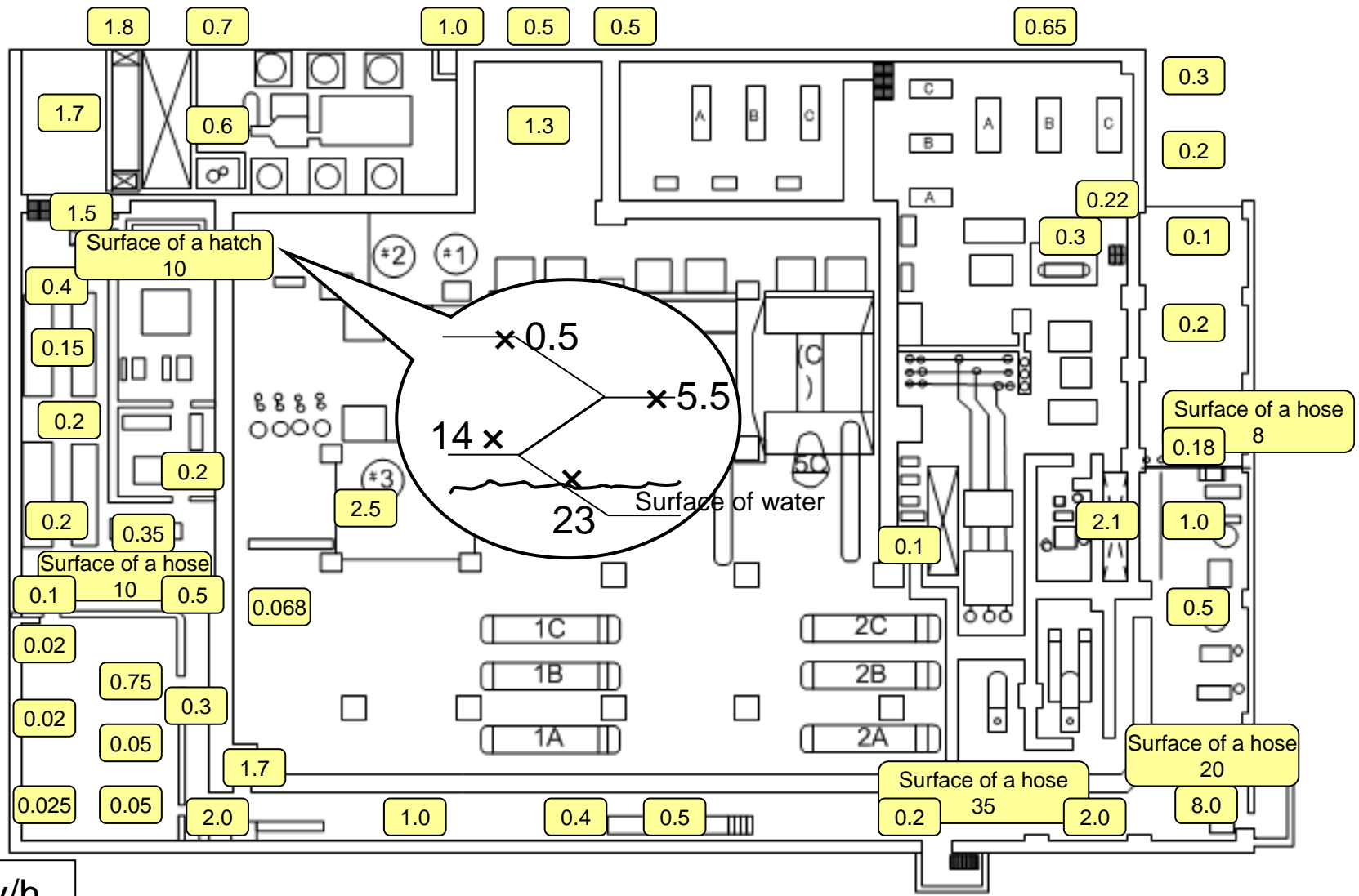

Unit: mSv/h

Unit 4 Turbine Building 1F

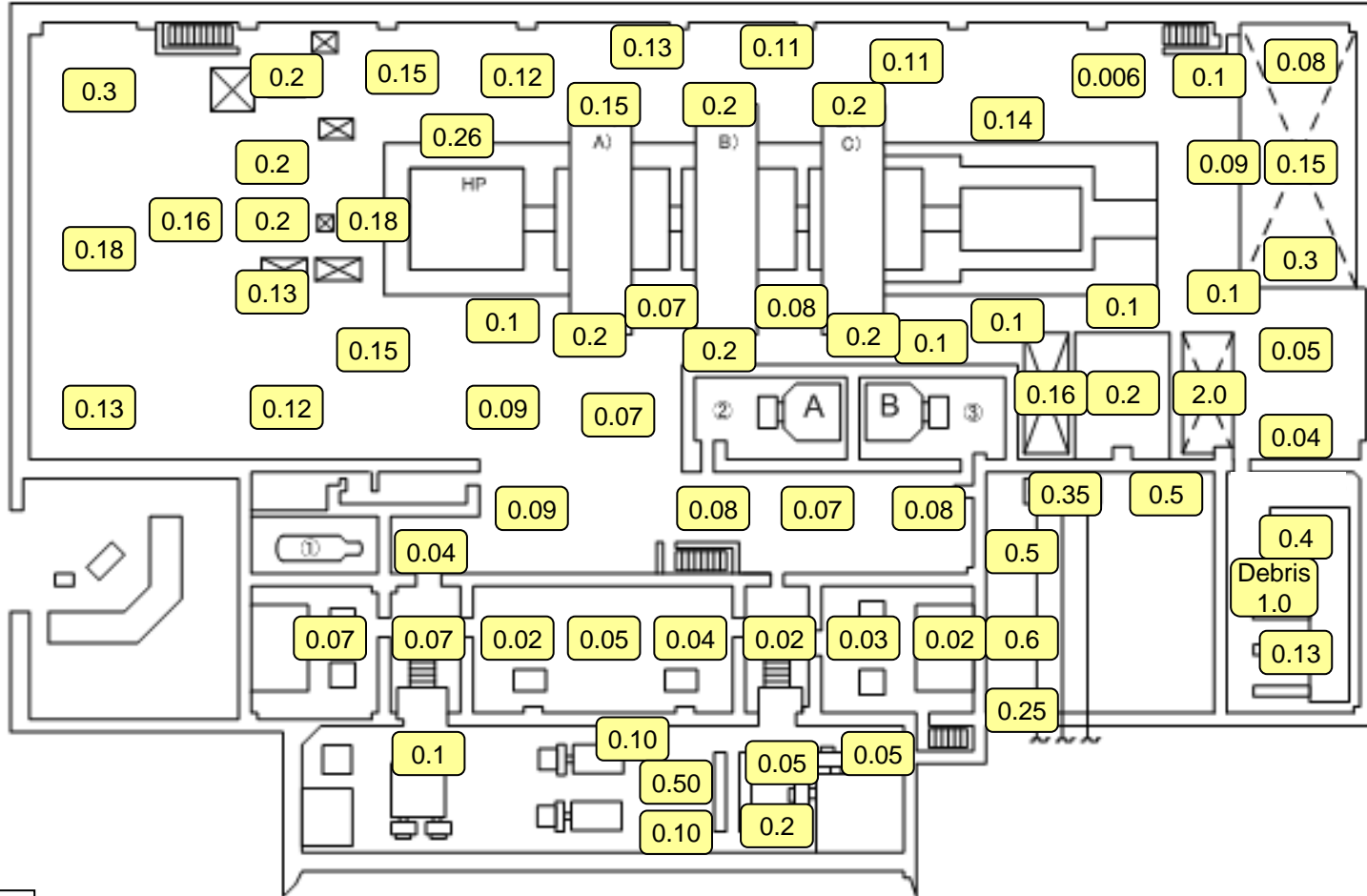

Unit: mSv/h

Unit 4 Turbine Building 2F

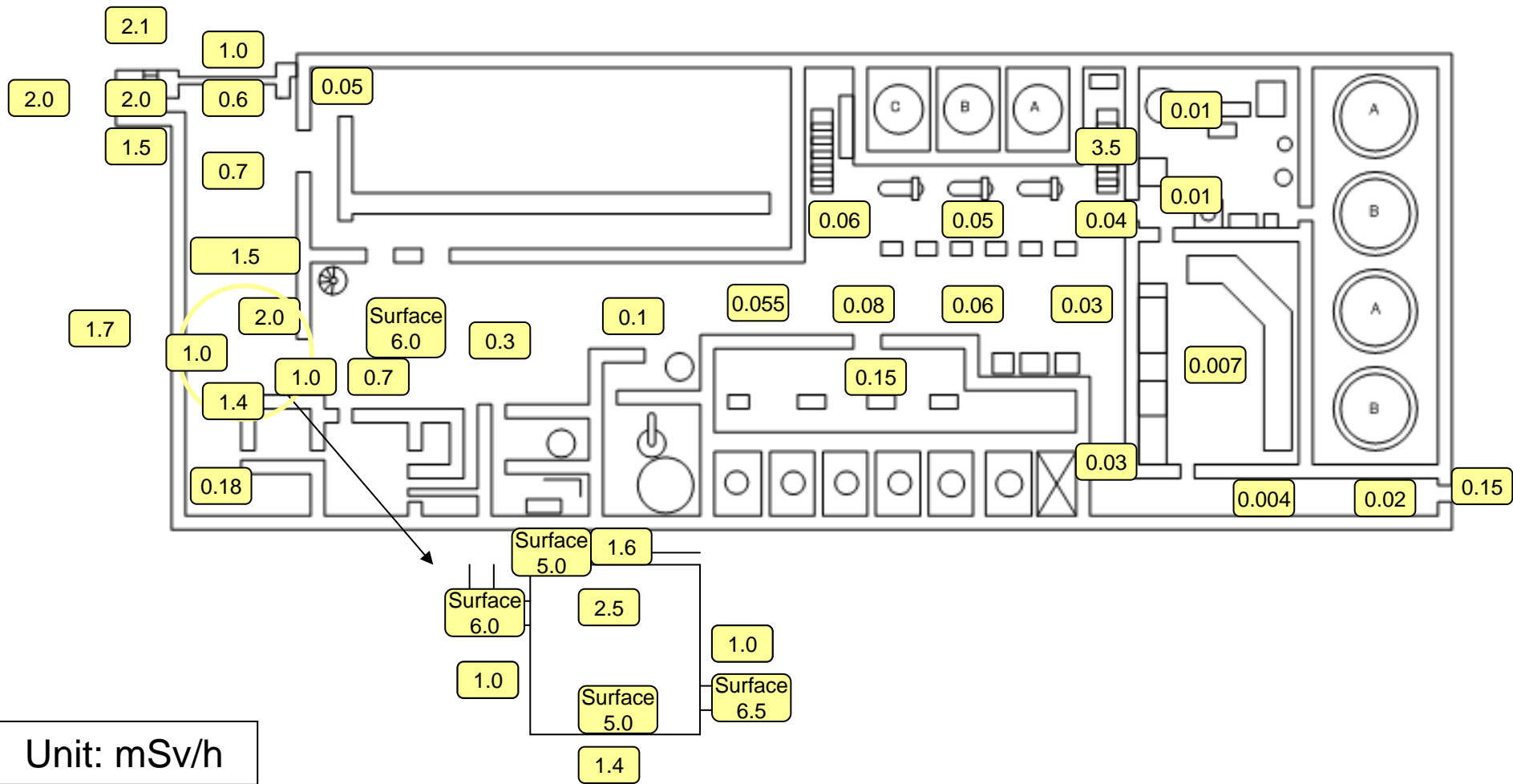

Unit 4 Waste Treatment Building 1F

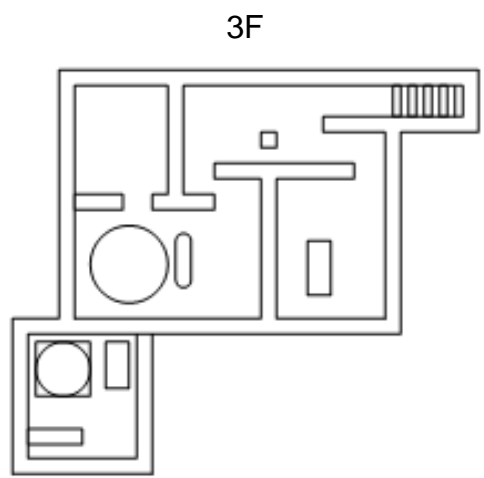
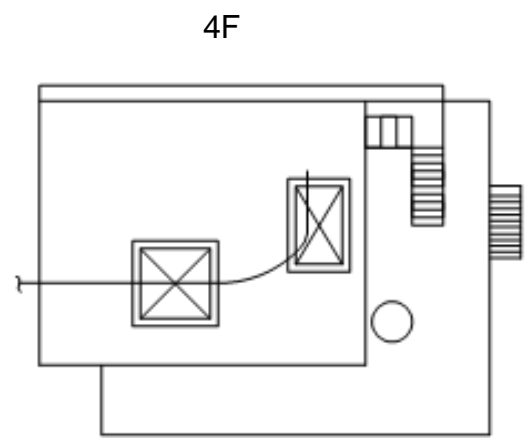
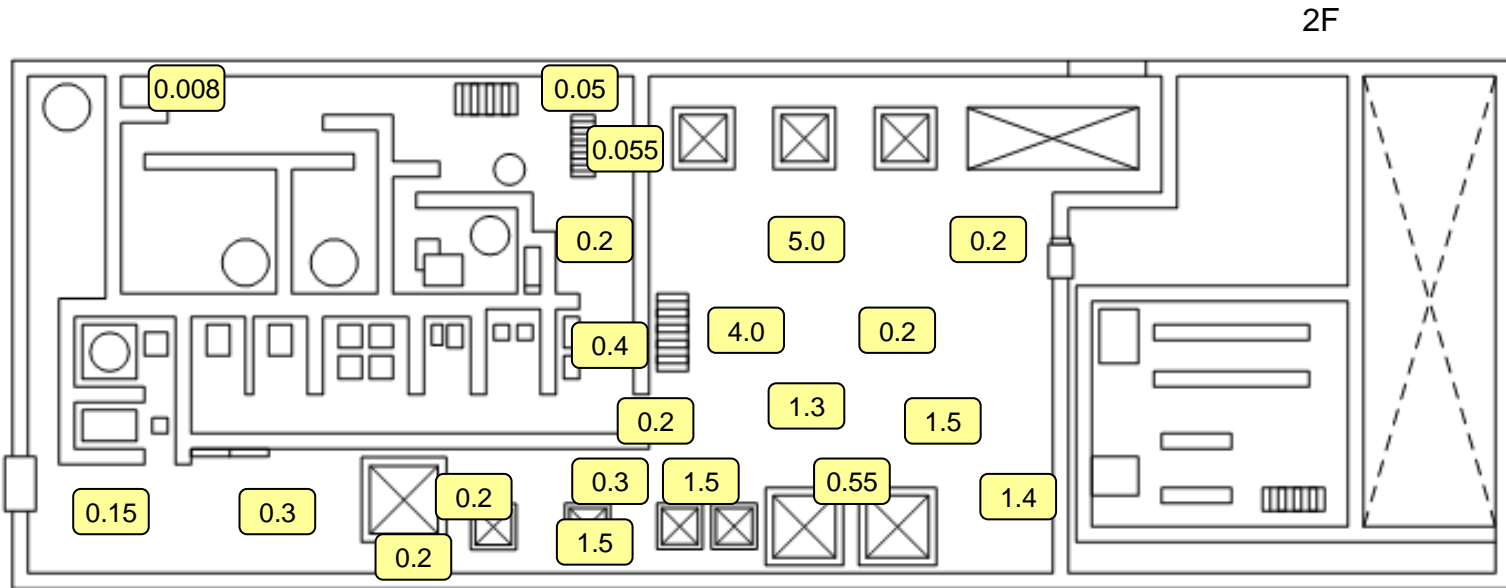

Unit: mSv/h

Unit 4 Waste Treatment Building 4F, 3F, 2F

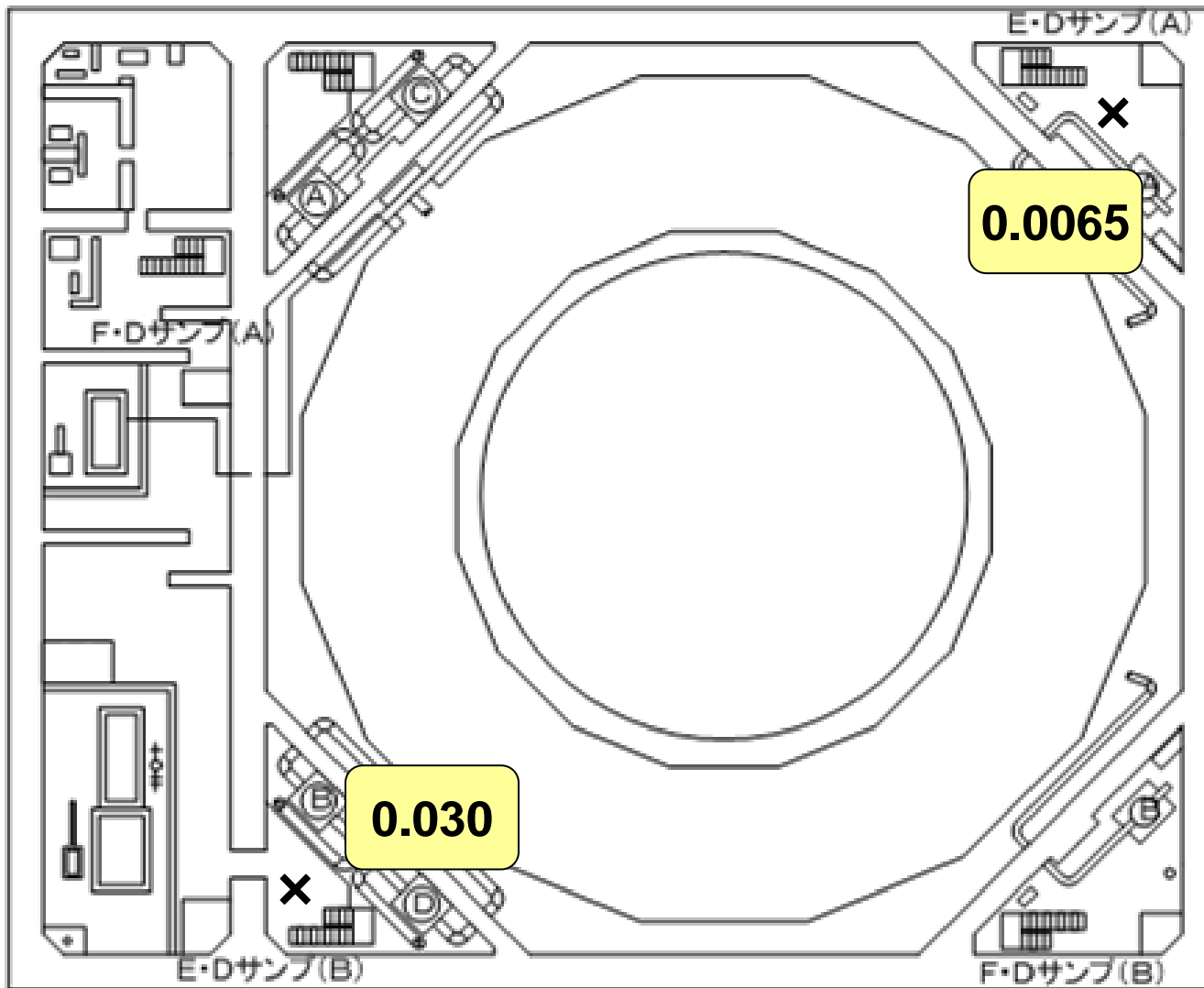

Unit: mSv/h

Unit 5 Reactor Building B1F

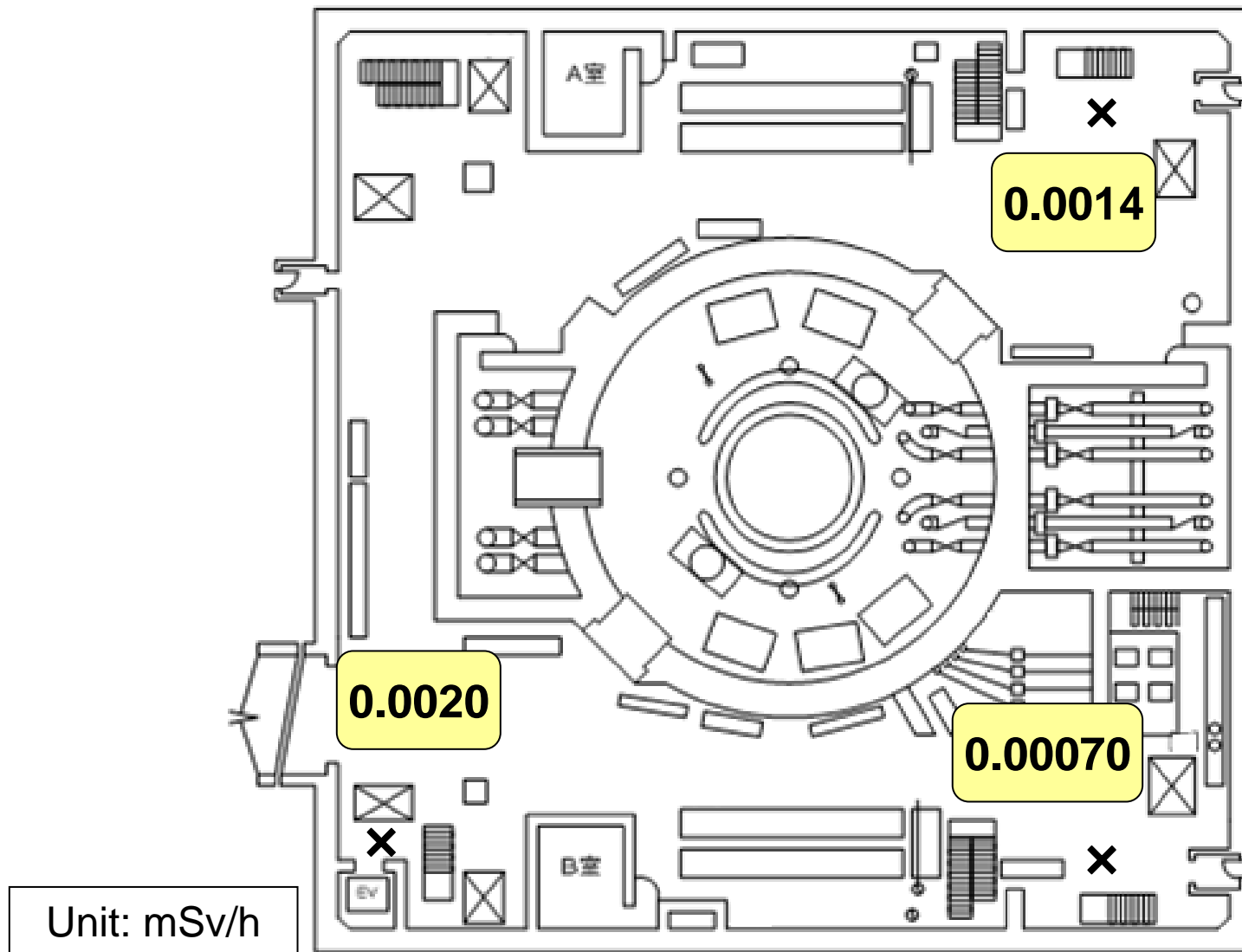

Unit 5 Reactor Building 1F

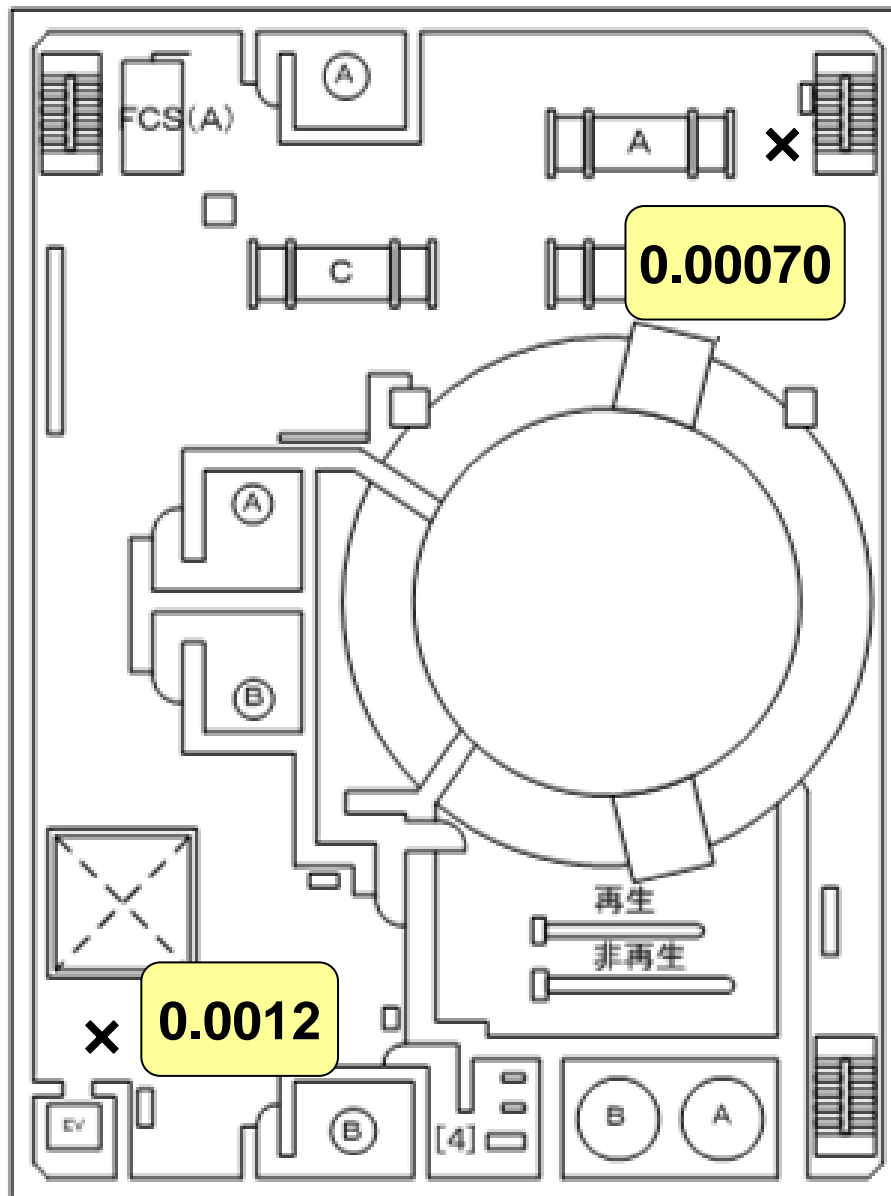

Unit: mSv/h

Unit 5 Reactor Building 2F

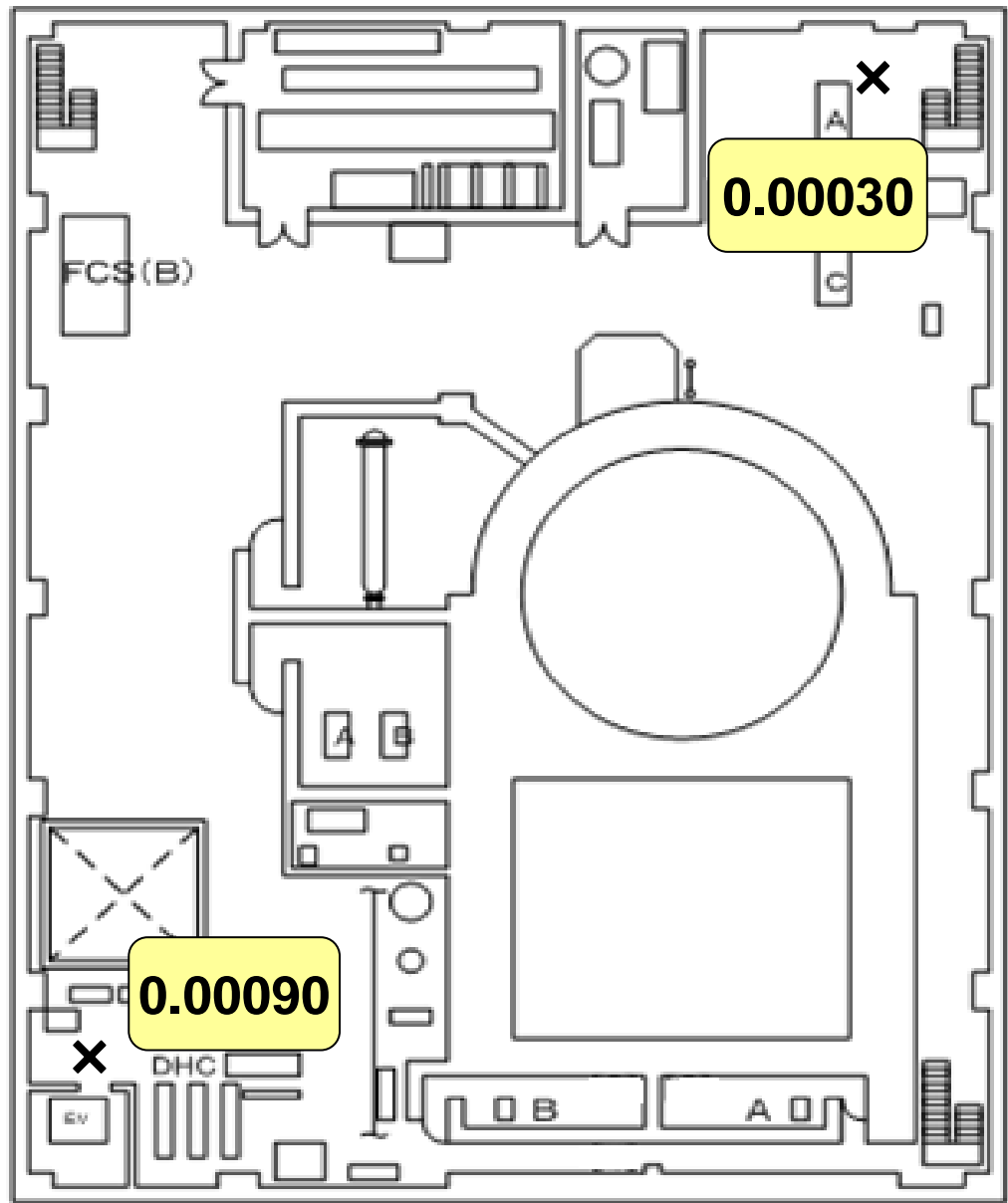

Unit: mSv/h

Unit 5 Reactor Building 3F

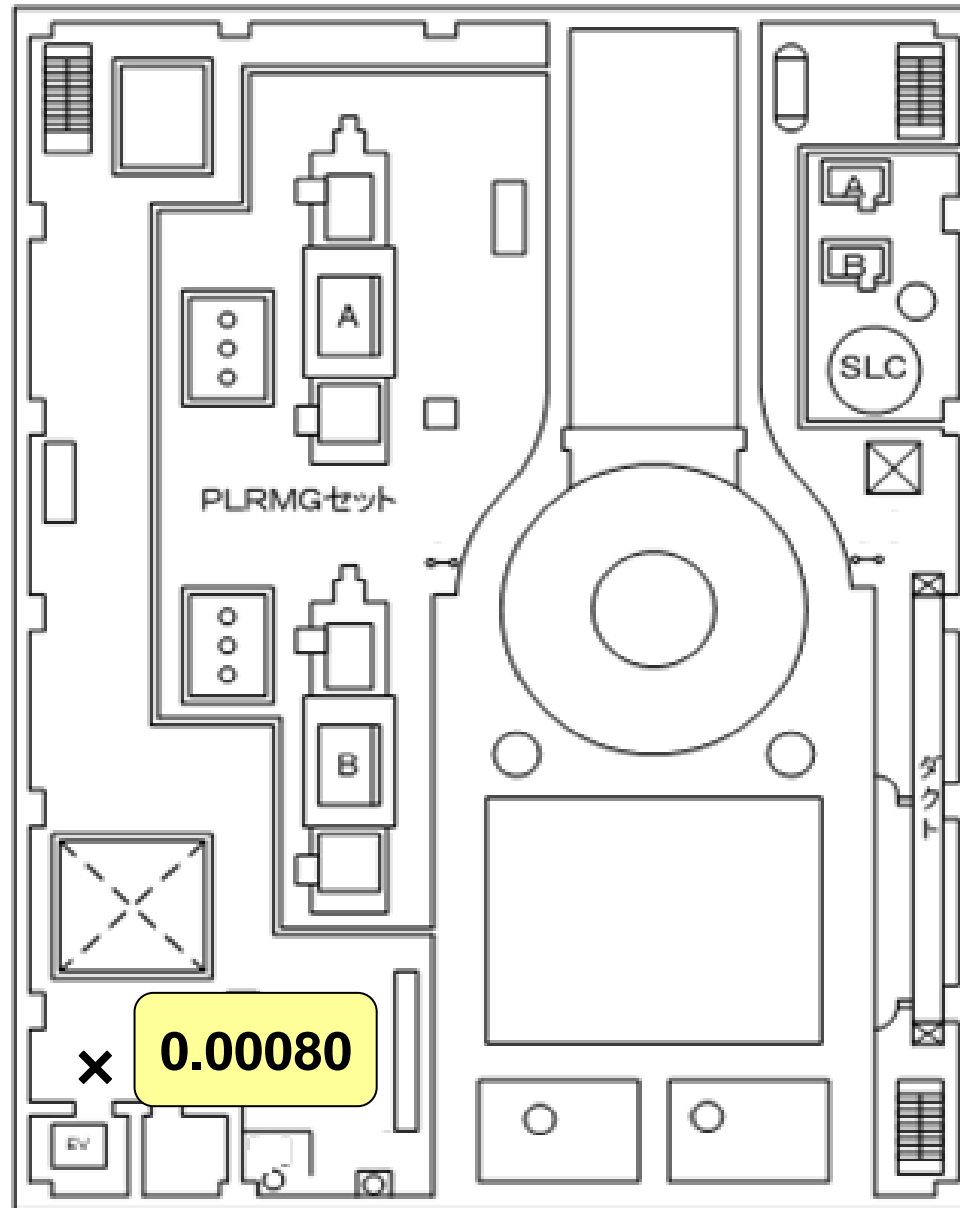

Unit: mSv/h

Unit 5 Reactor Building 4F

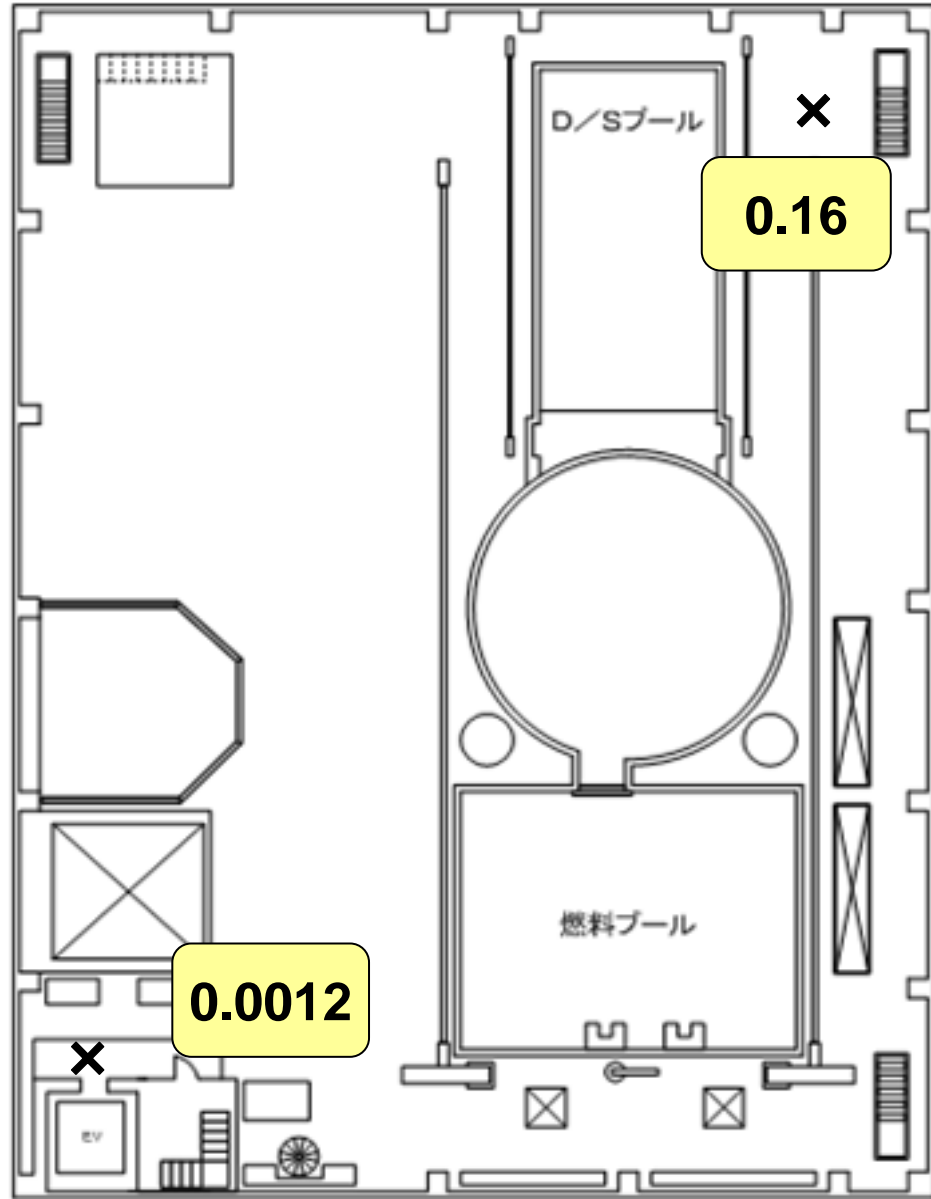

Unit: mSv/h

Unit 5 Reactor Building 5F

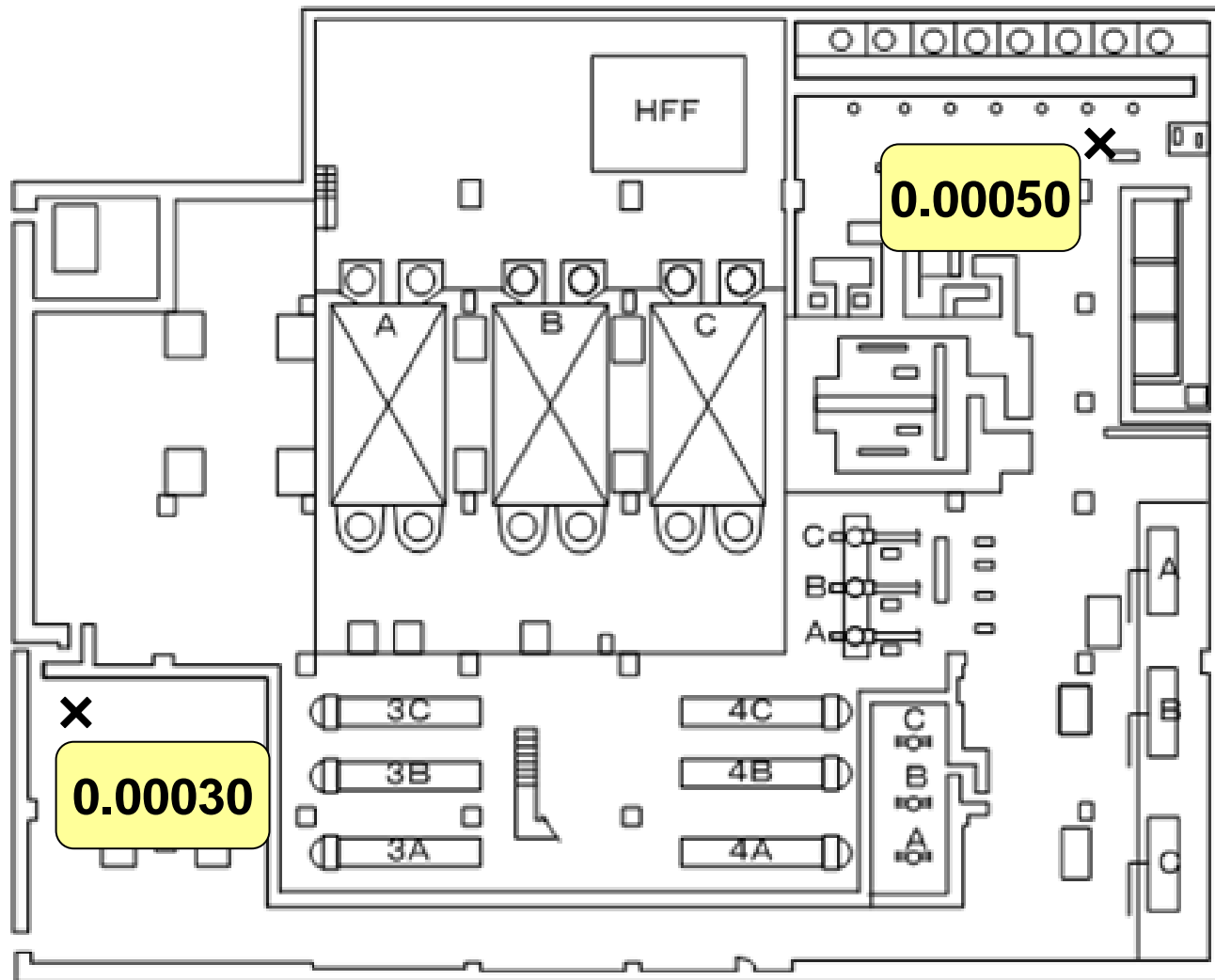

Unit: mSv/h

Unit 5 Turbine Building B1F

Unit: mSv/h

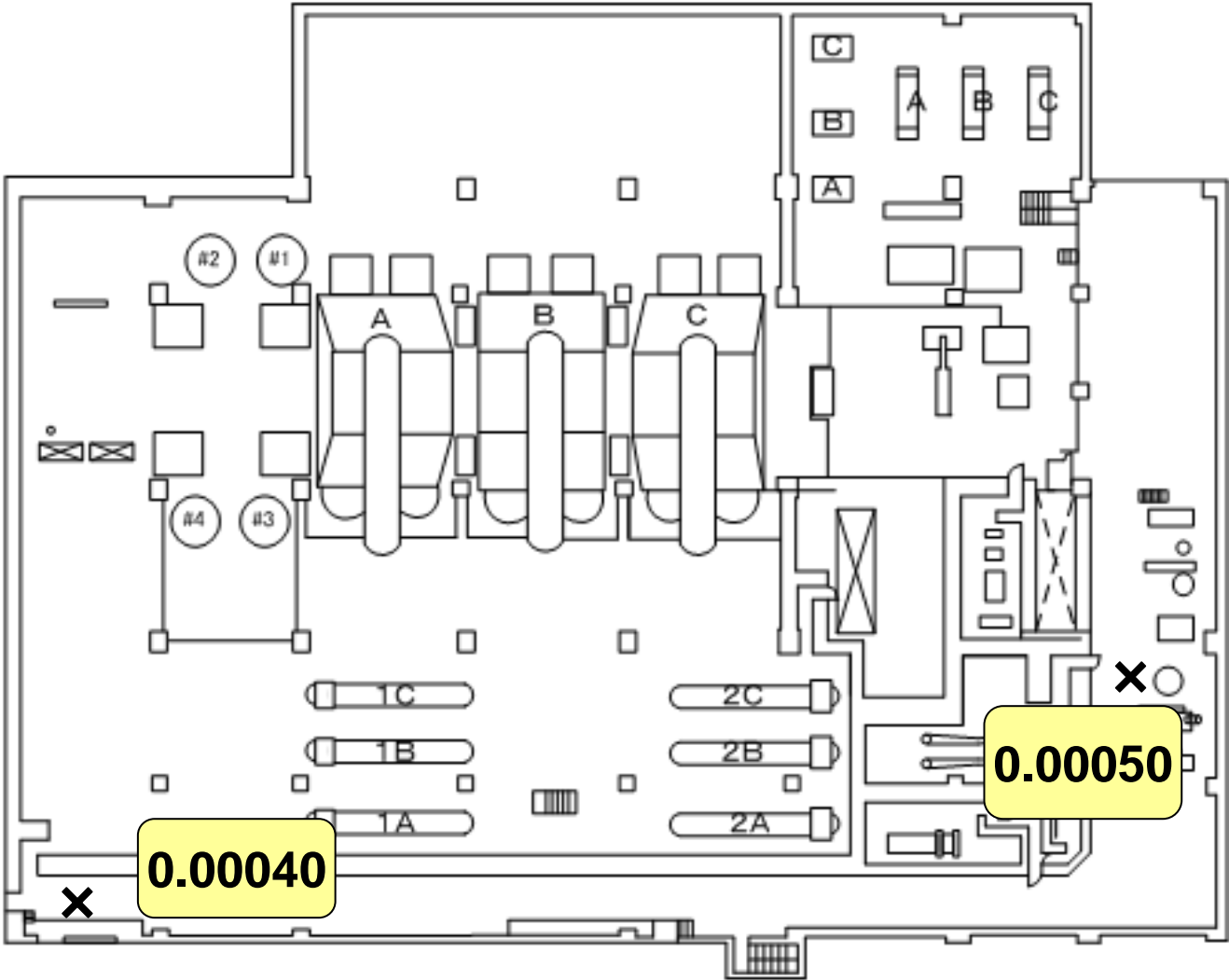

Unit 5 Turbine Building 1F

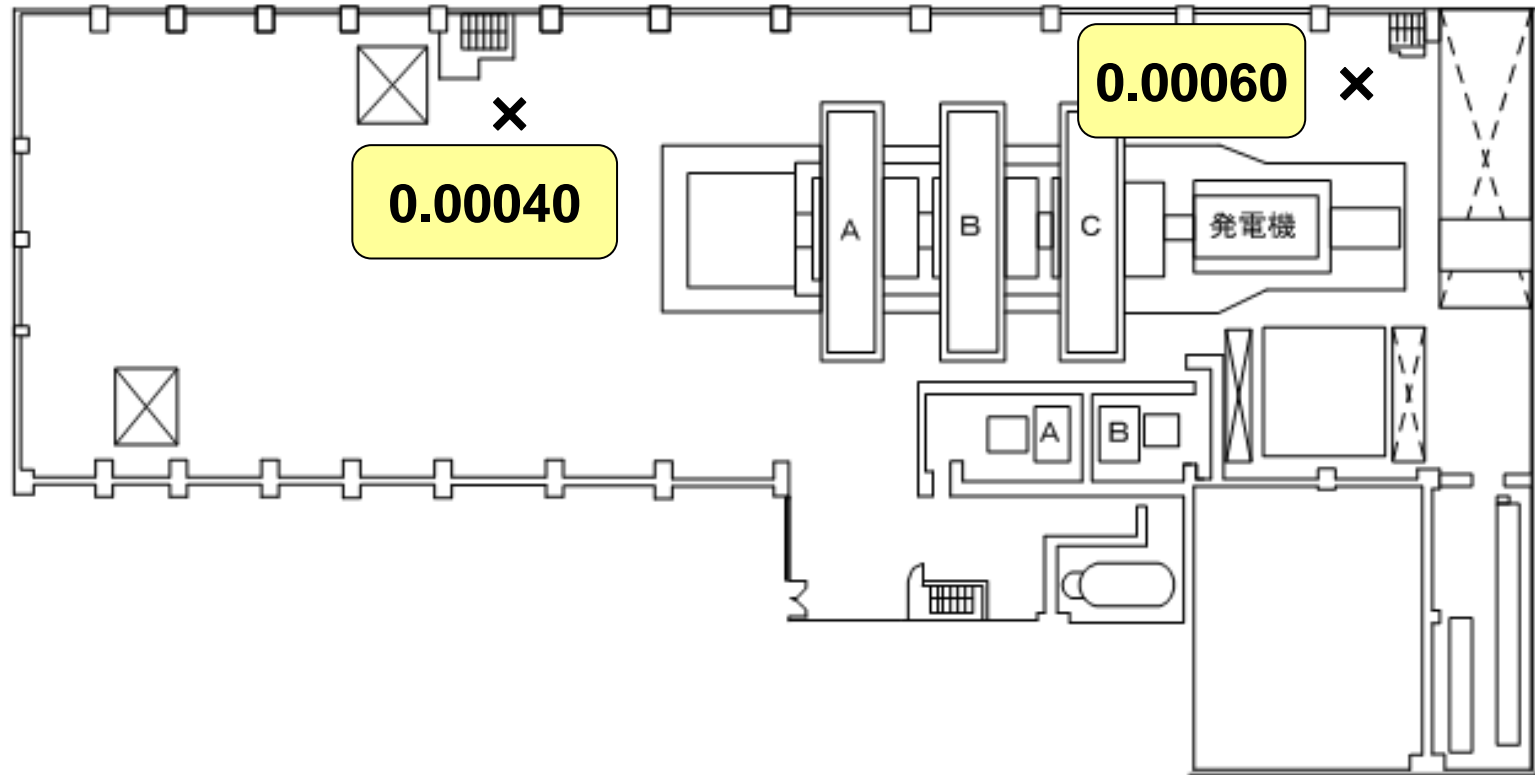

Unit: mSv/h

Unit 5 Turbine Building 2F

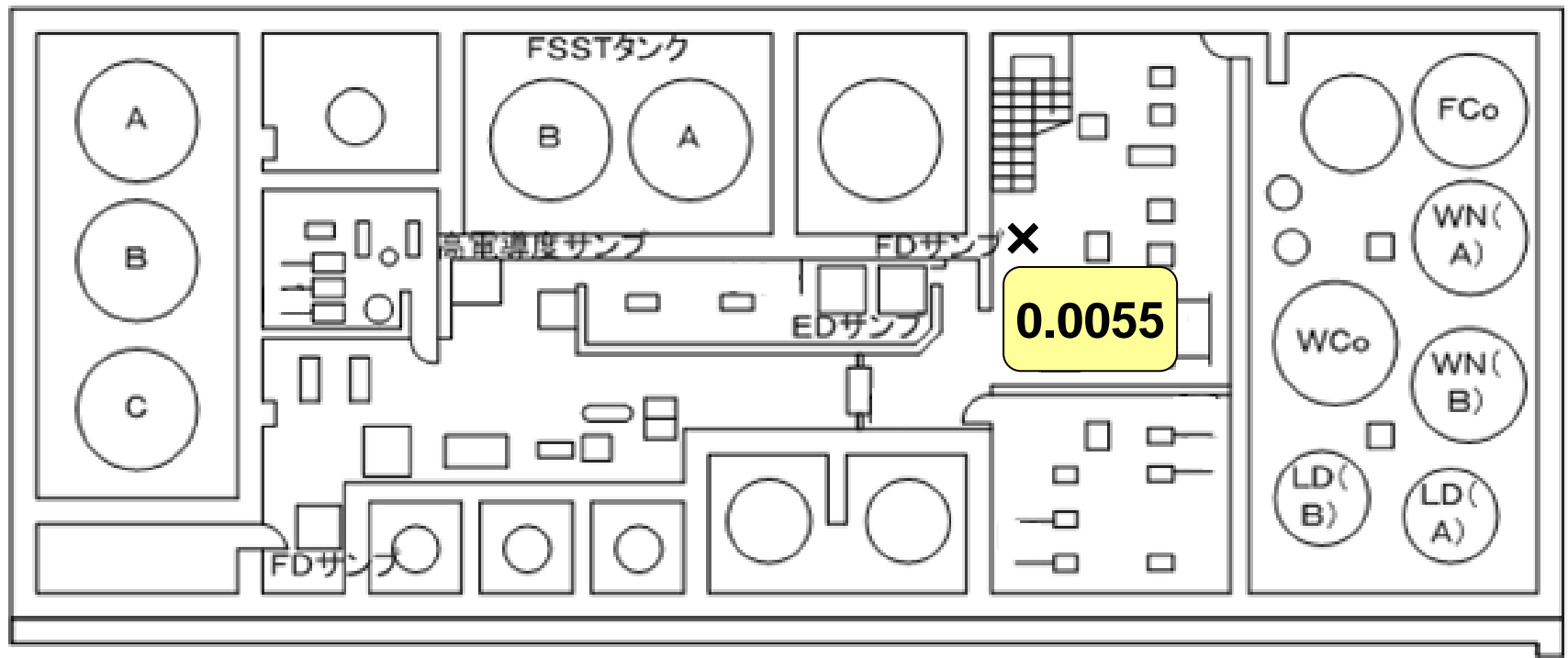

Unit: mSv/h

Unit 5 Waste Treatment Building B1F

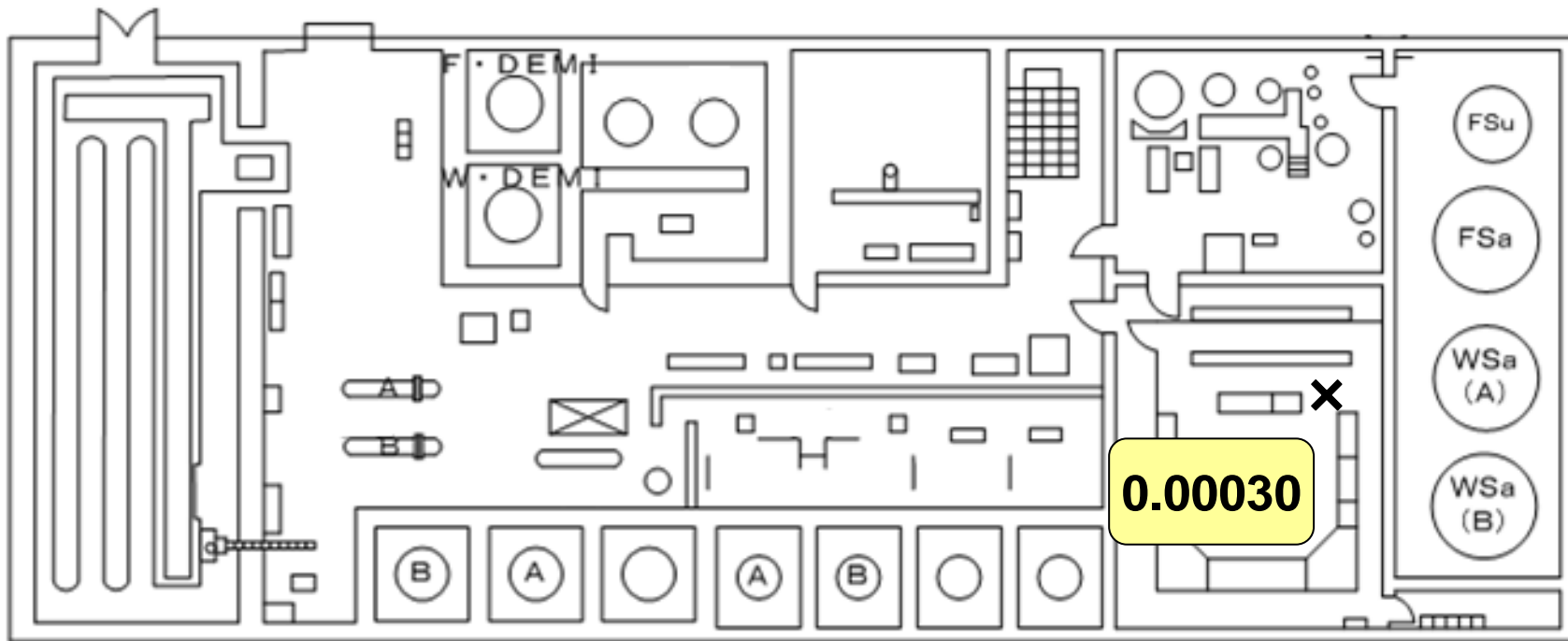

Unit: mSv/h

Unit 5 Waste Treatment Building 1F

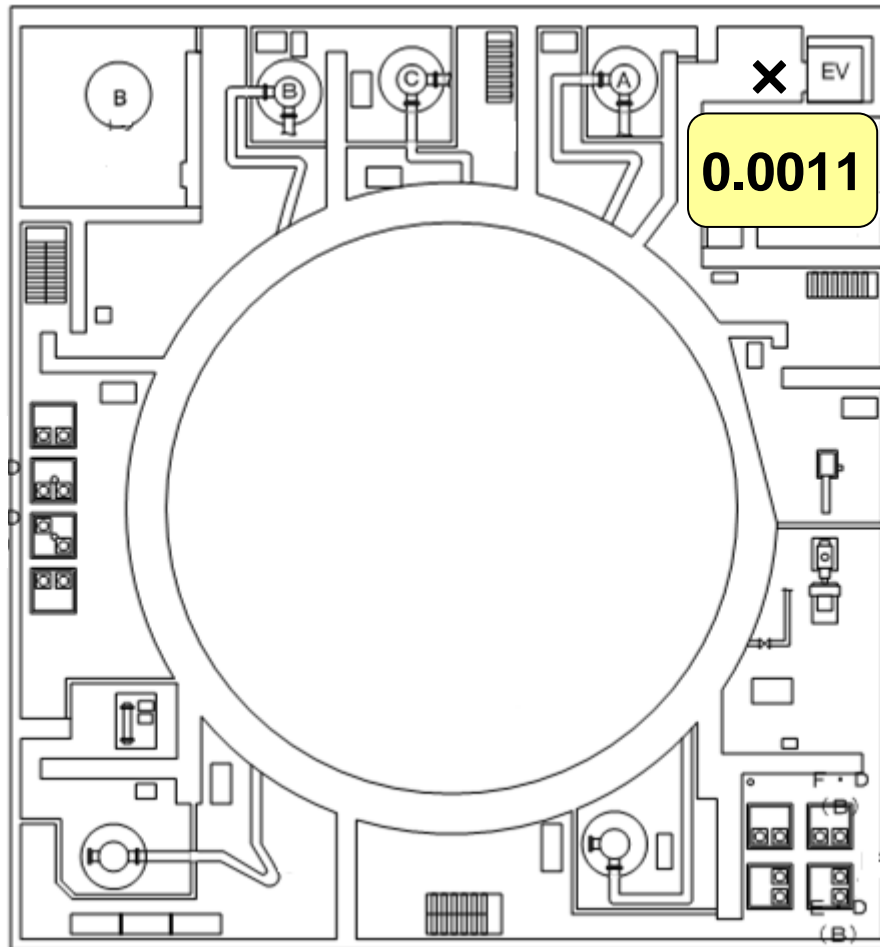

Unit: mSv/h

Unit 6 Reactor Building B2F

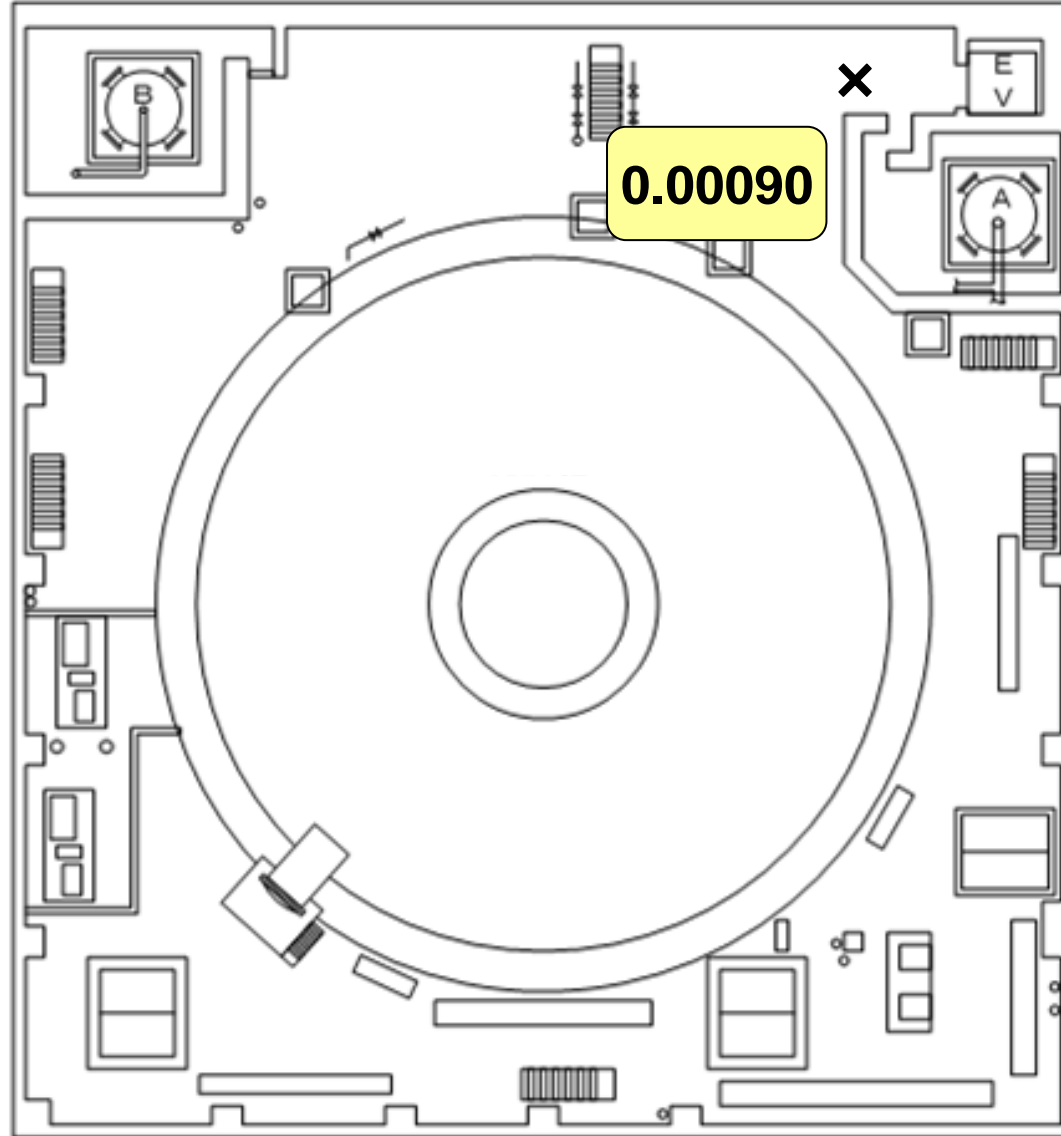

Unit: mSv/h

Unit 6 Reactor Building B1F

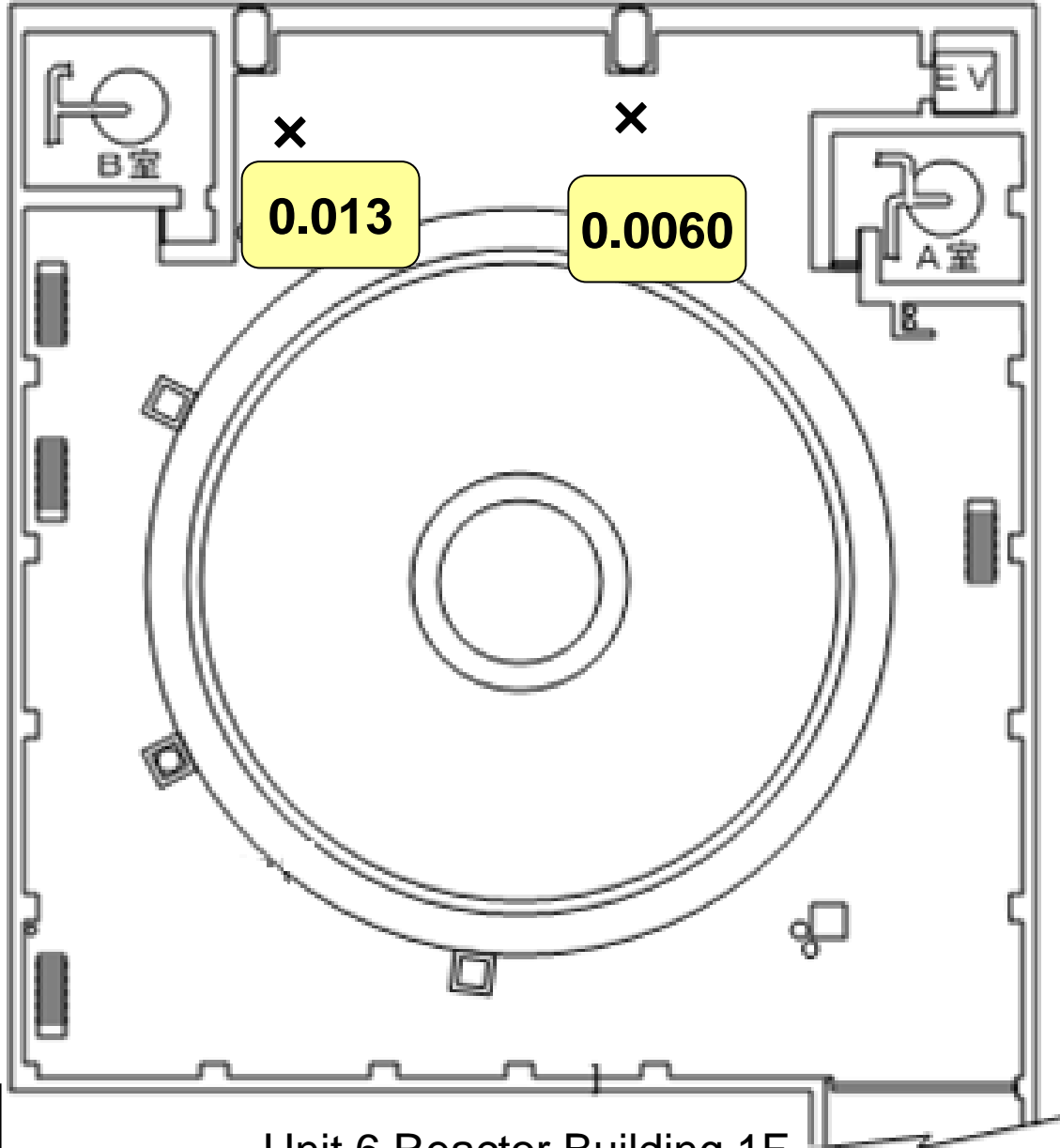

Unit: mSv/h

Unit 6 Reactor Building 1F

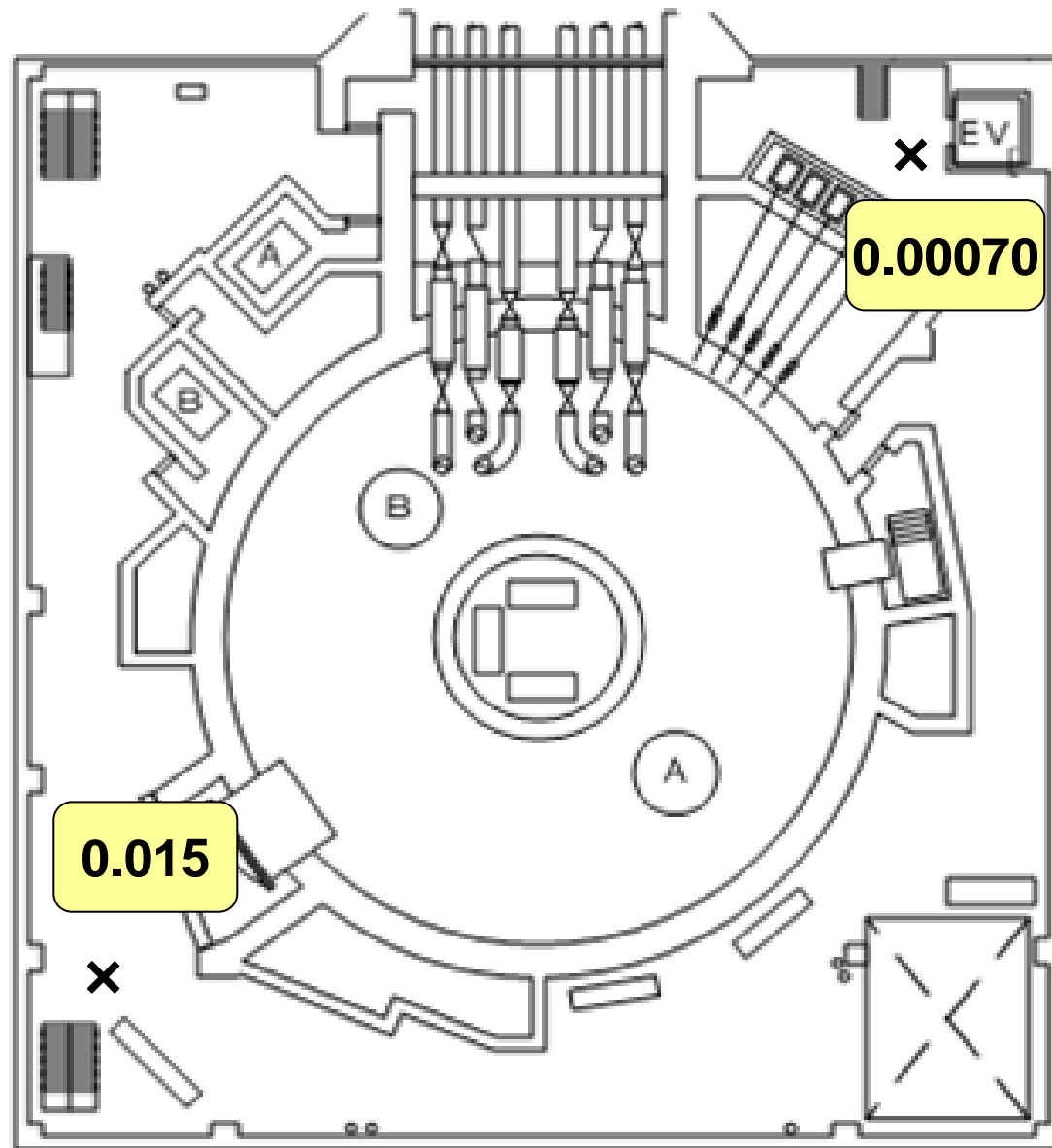

Unit: mSv/h

Unit 6 Reactor Building 2F

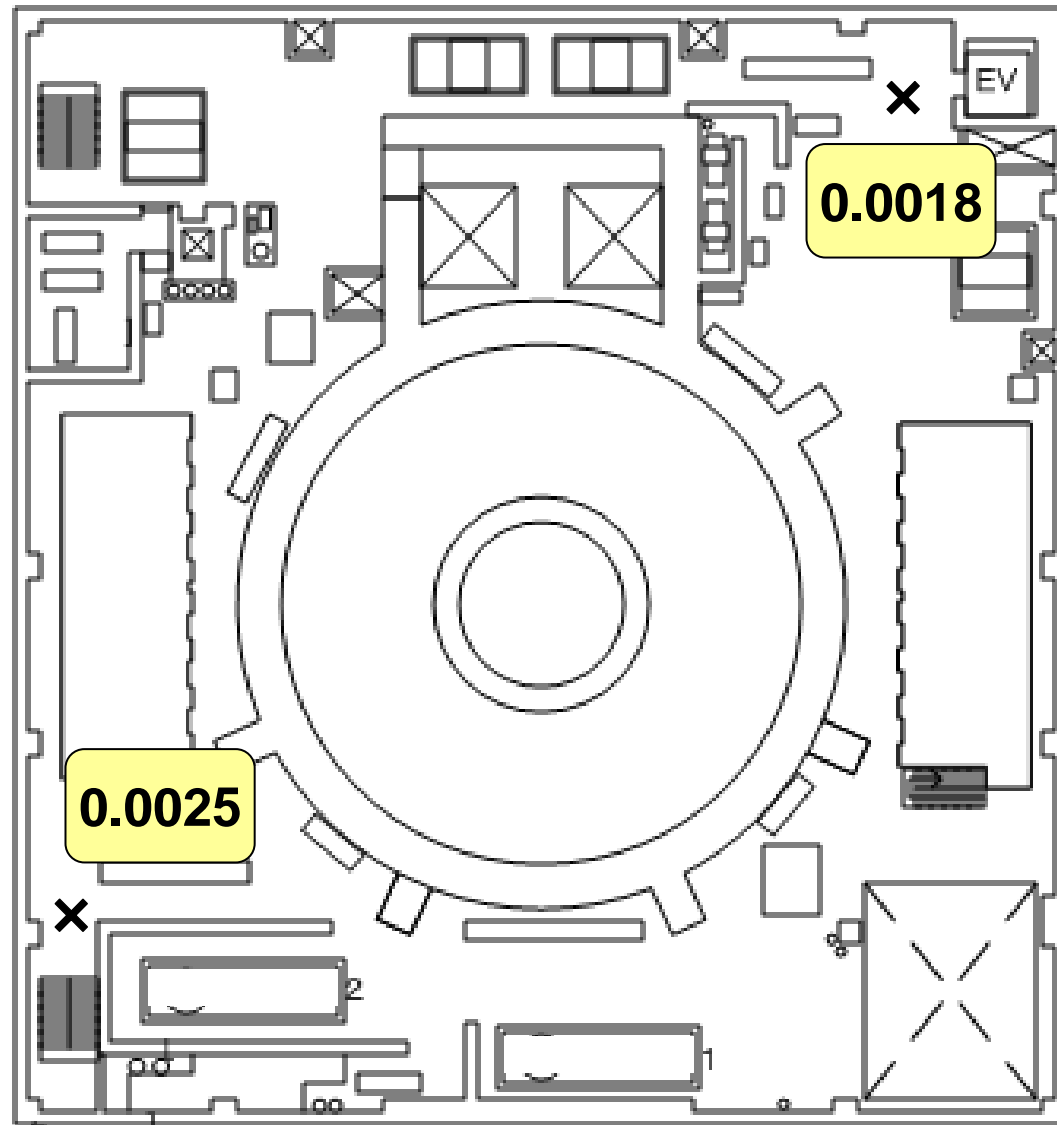

Unit: mSv/h

Unit 6 Reactor Building 3F

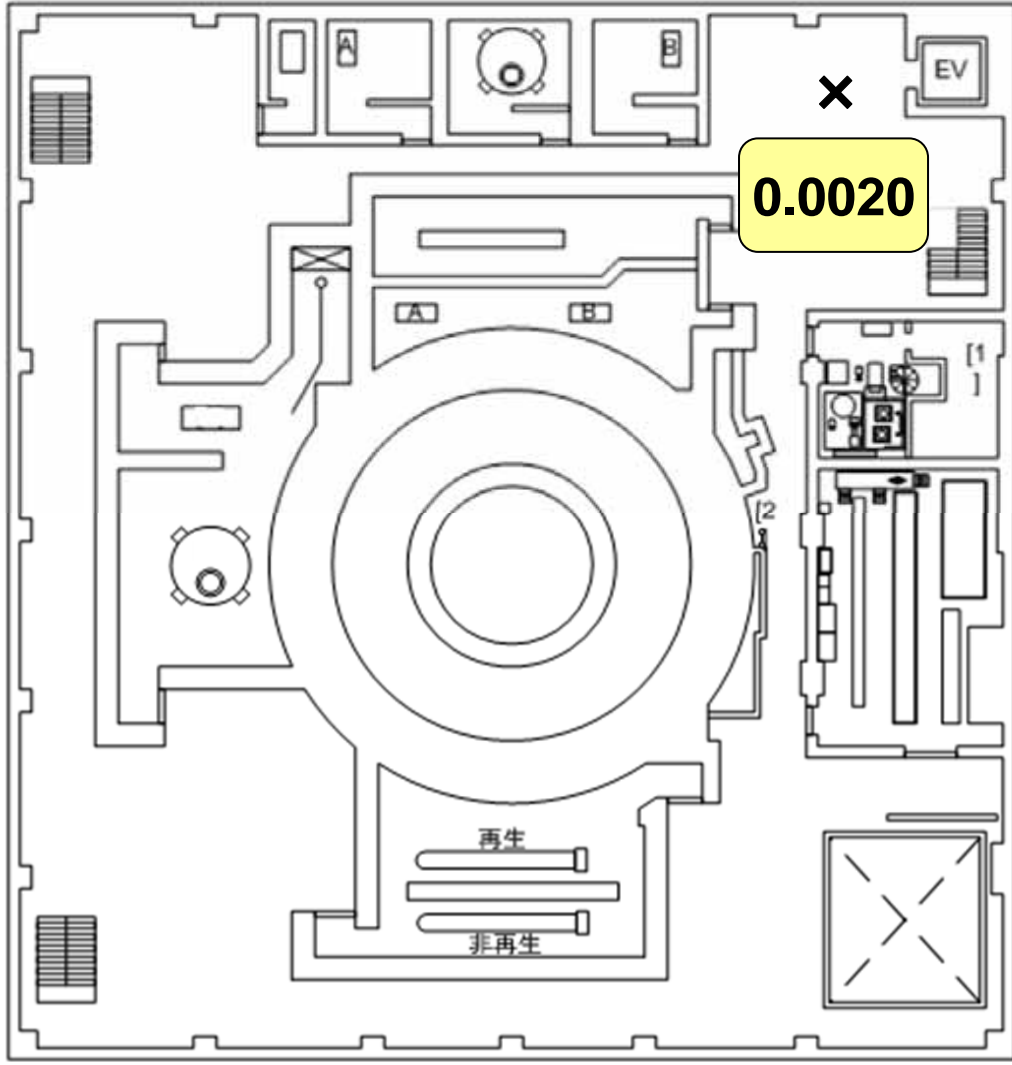

Unit: mSv/h

Unit 6 Reactor Building 4F

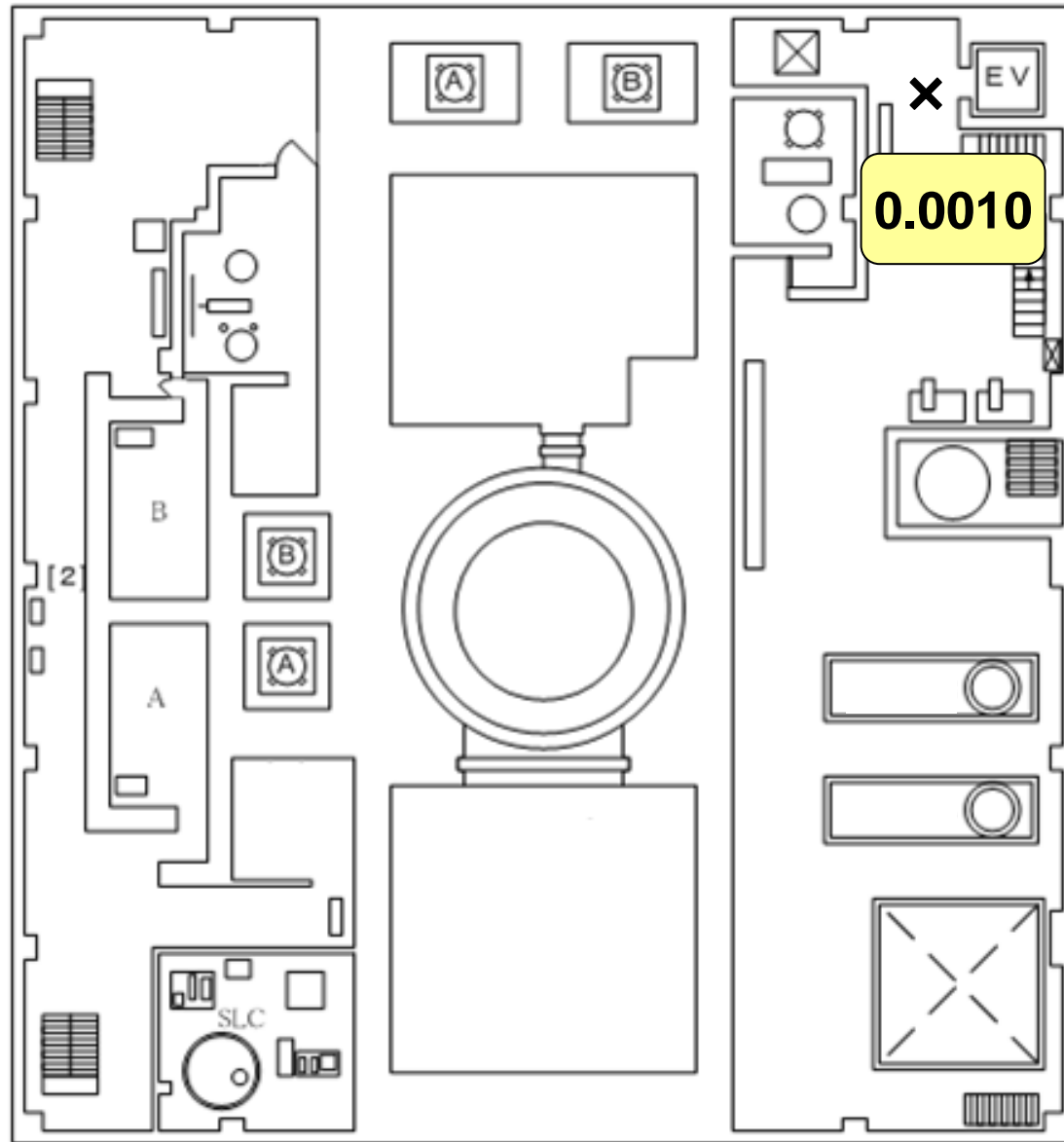

Unit: mSv/h

Unit 6 Reactor Building 5F

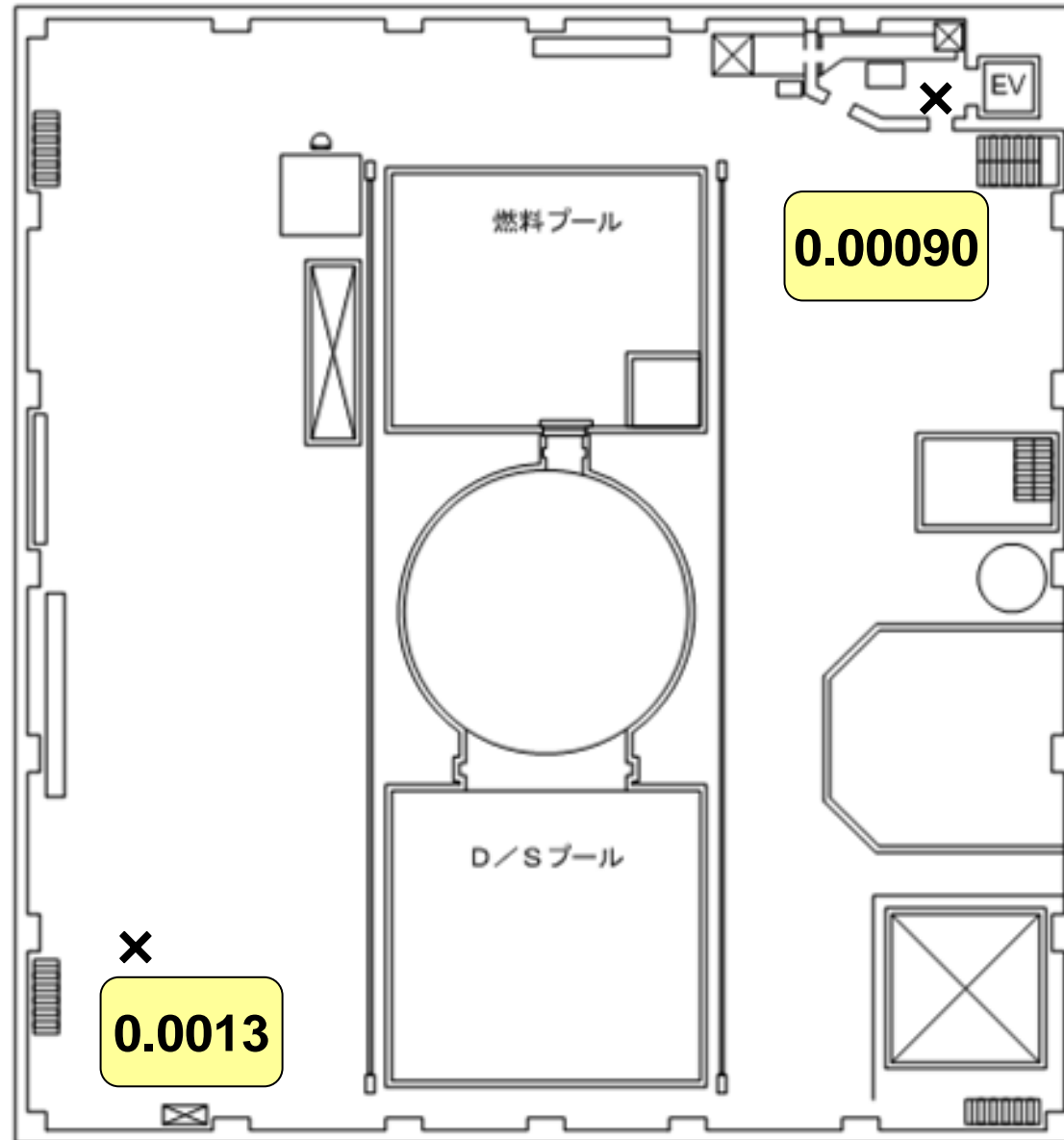

Unit: mSv/h

Unit 6 Reactor Building 6F

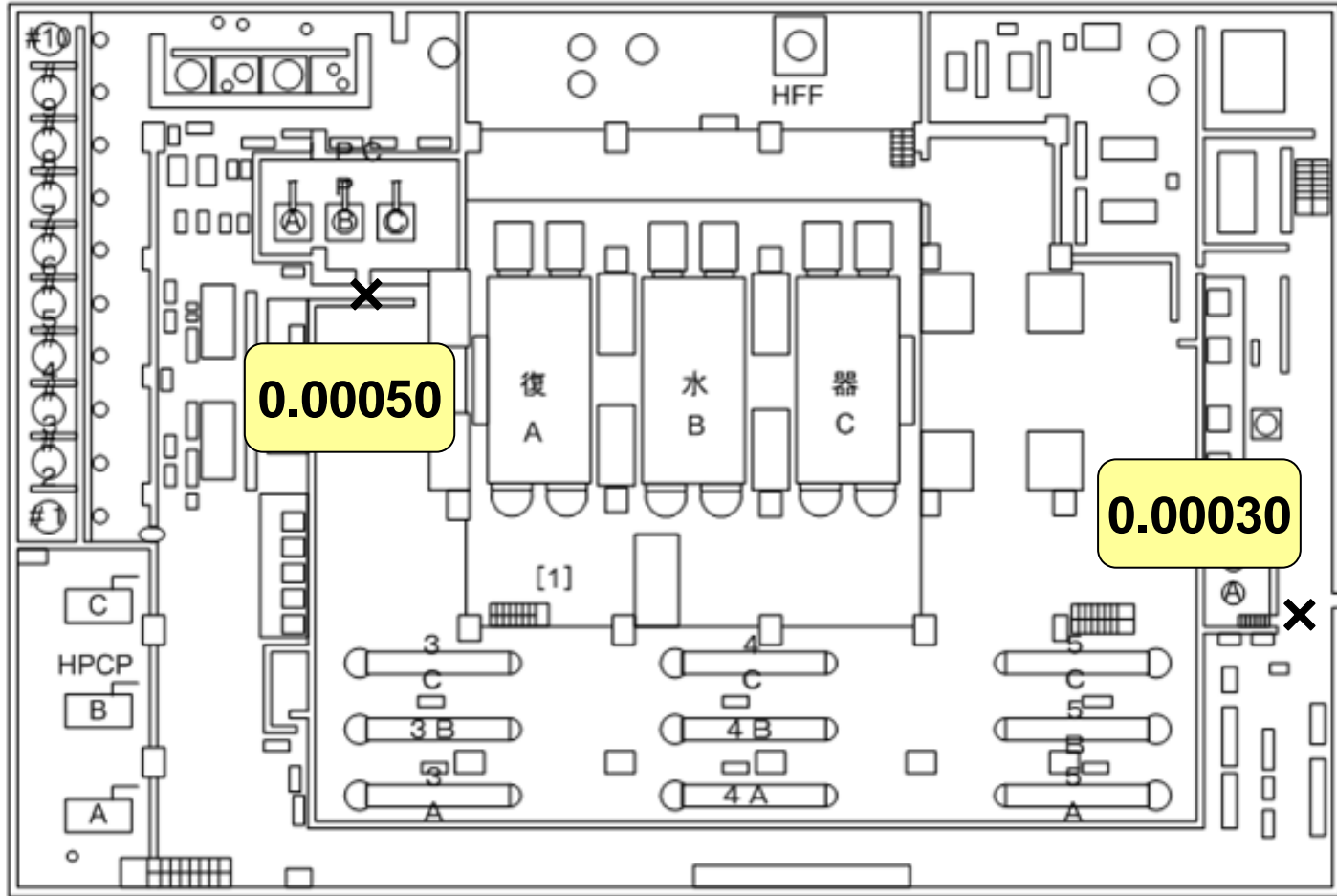

Unit: mSv/h

Unit 6 Turbine Building B1F

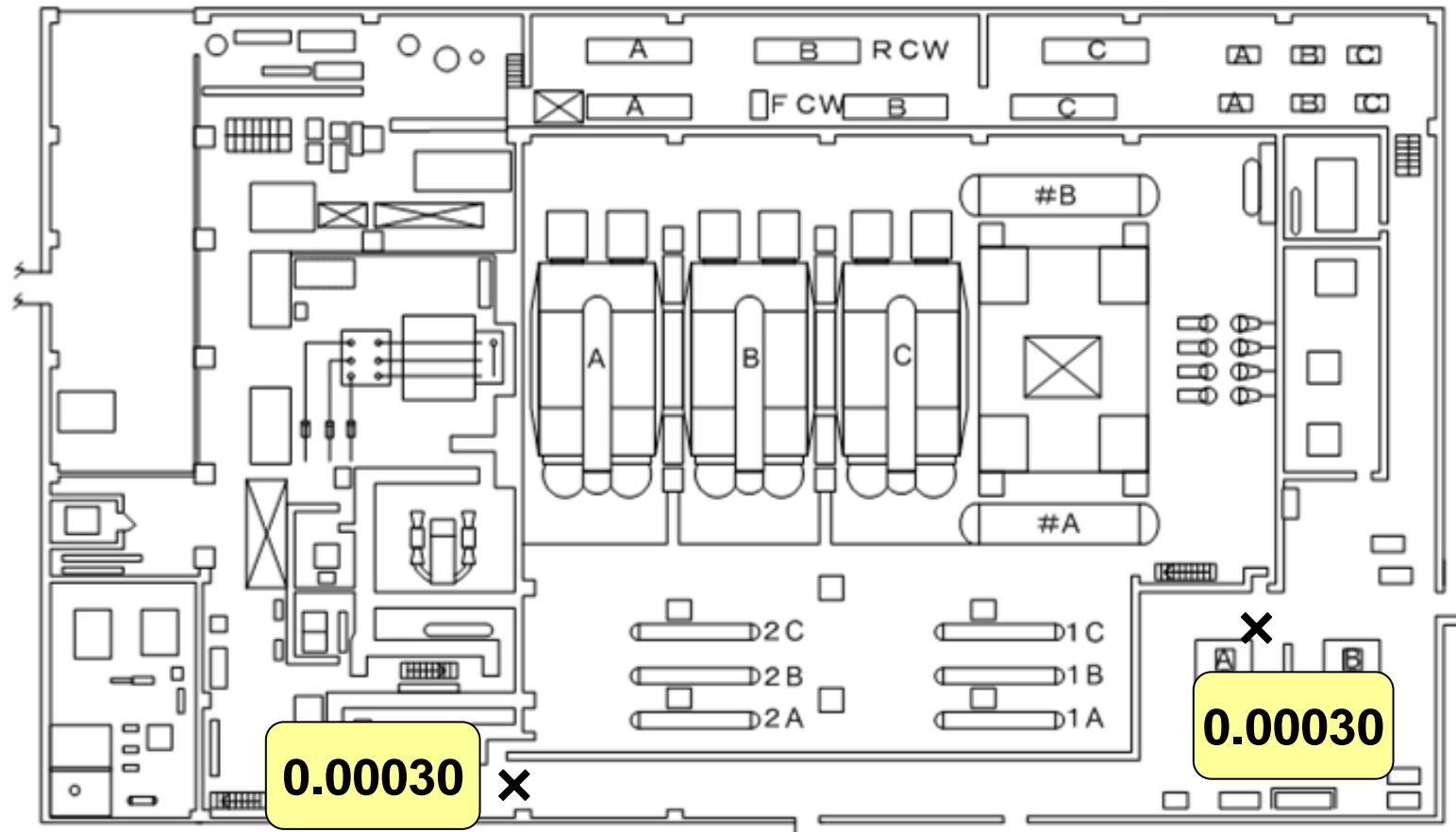

Unit: mSv/h

Unit 6 Turbine Building 1F

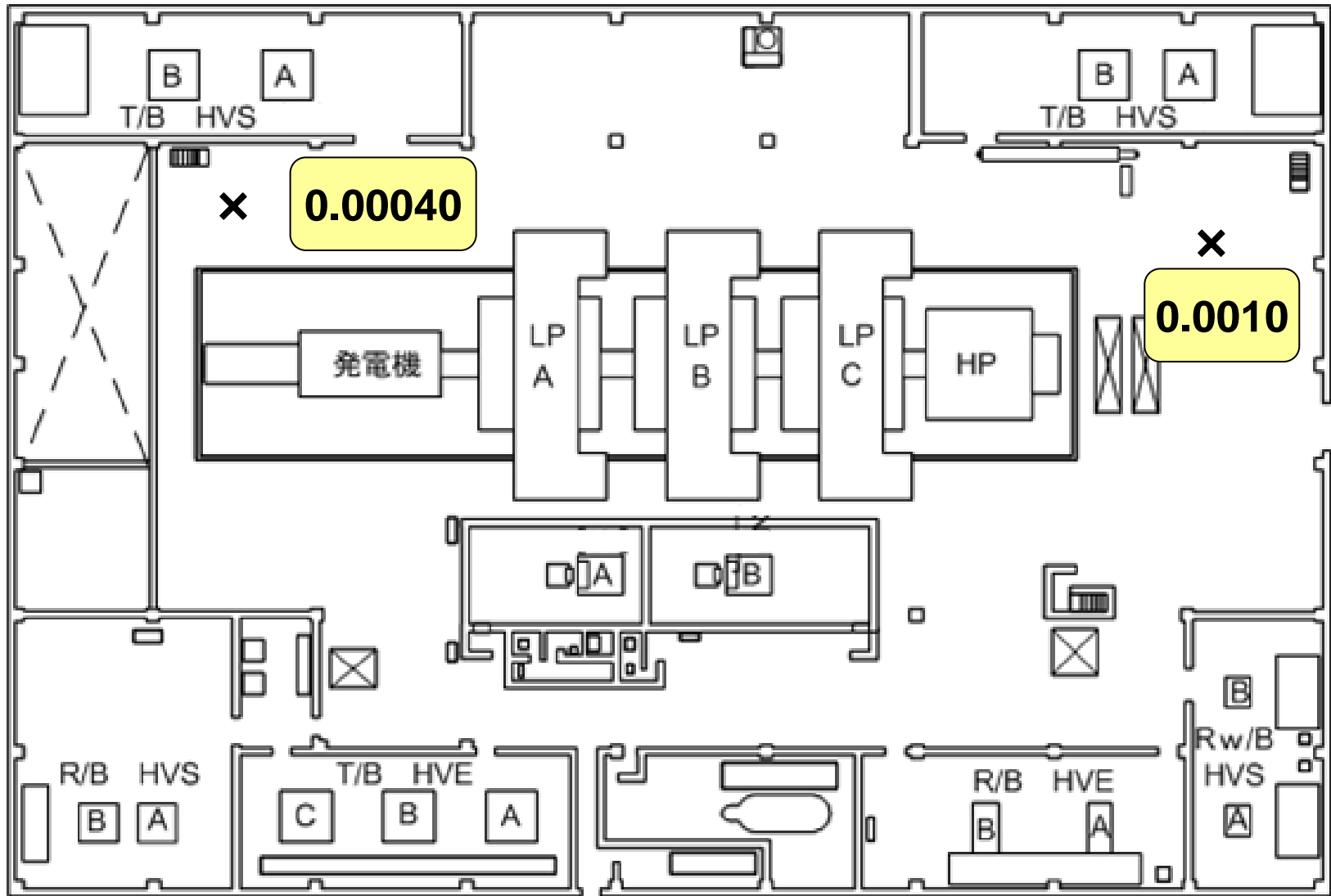

Unit: mSv/h

Unit 6 Turbine Building 2F

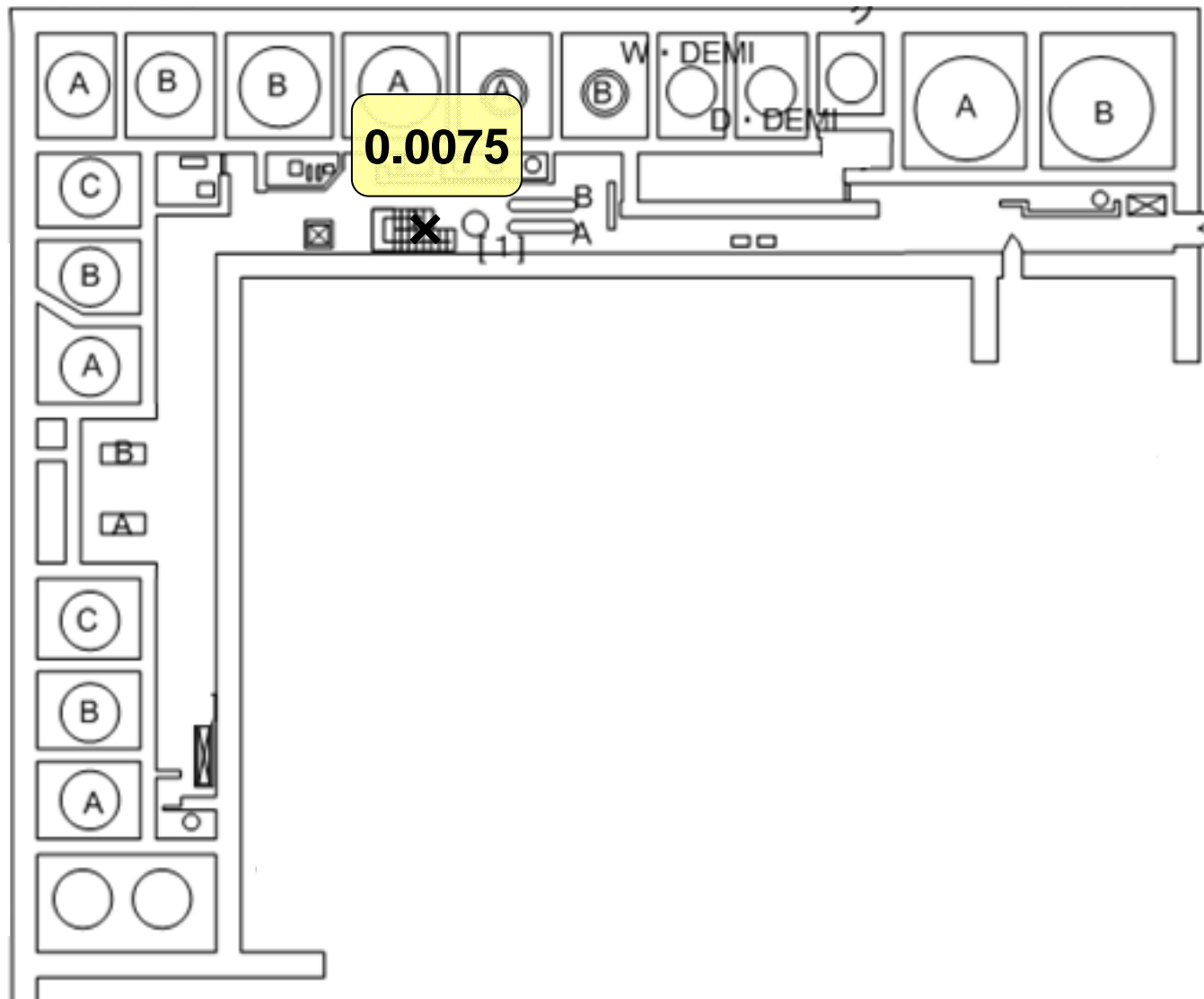

Unit: mSv/h

Unit 6 Waste Treatment Building B1F

ベ어링エリア

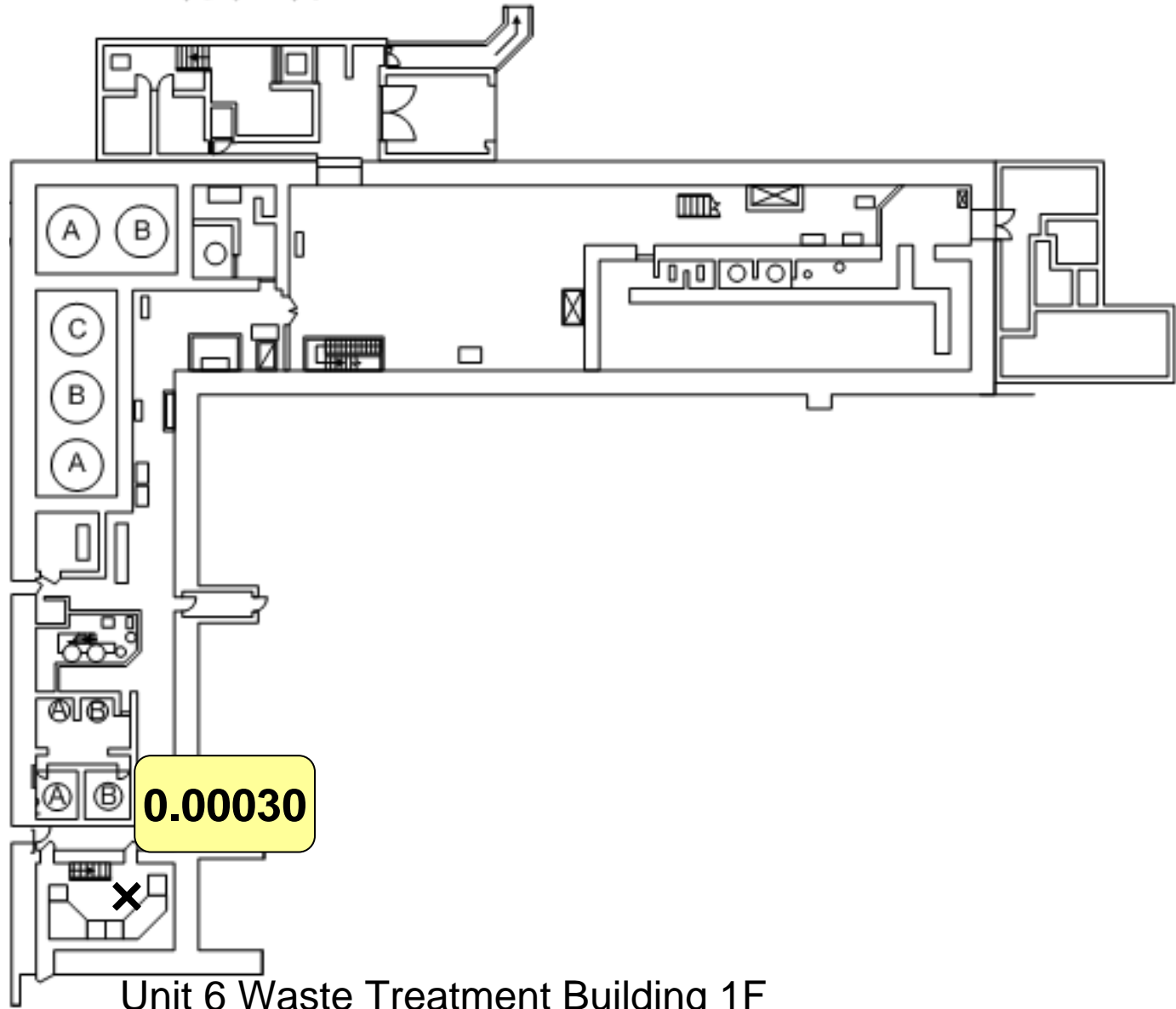

Unit: mSv/h

Unit 6 Waste Treatment Building 1F



Process Main Building 1F



Process Main Building 2F

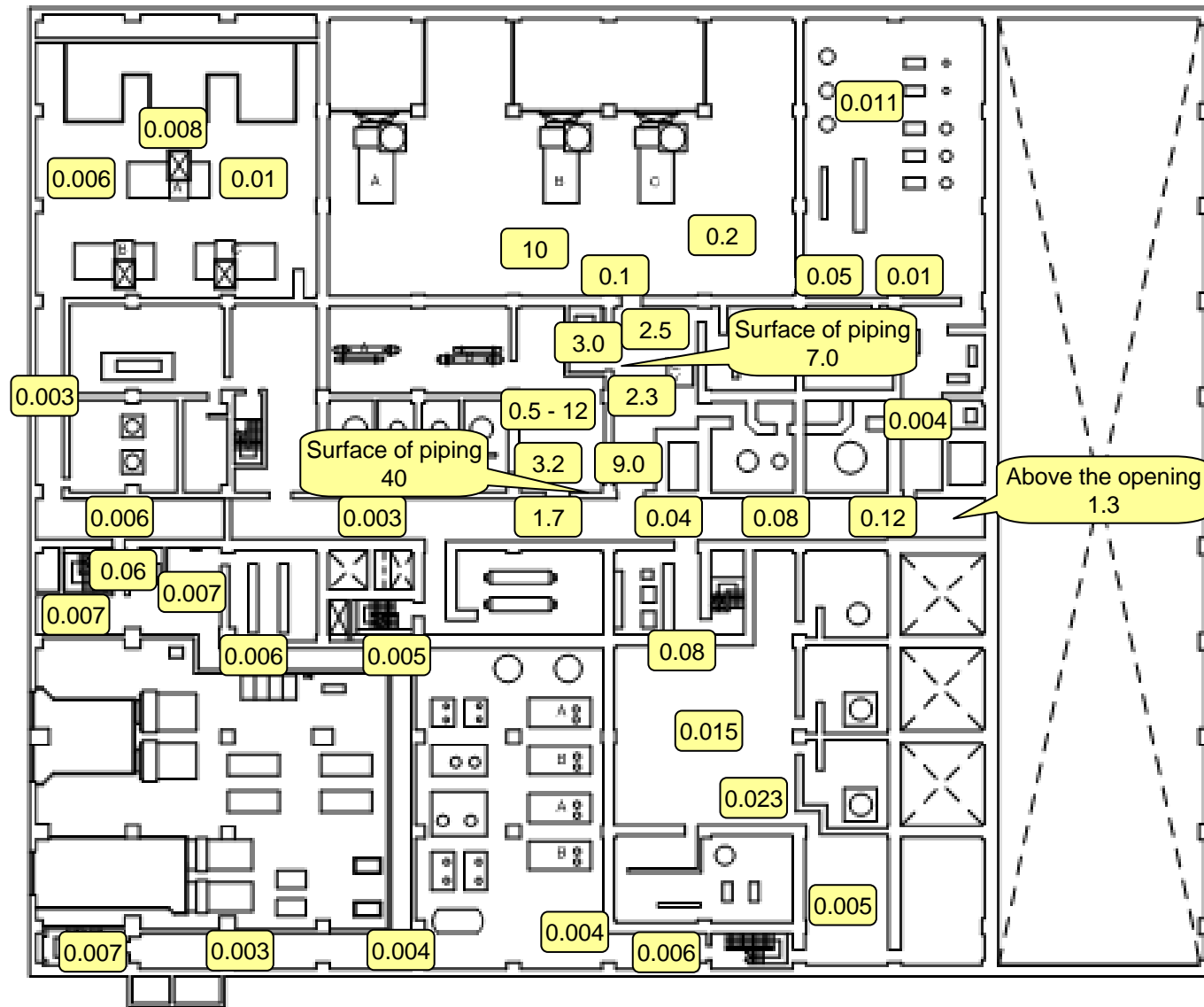

Process Main Building 3F

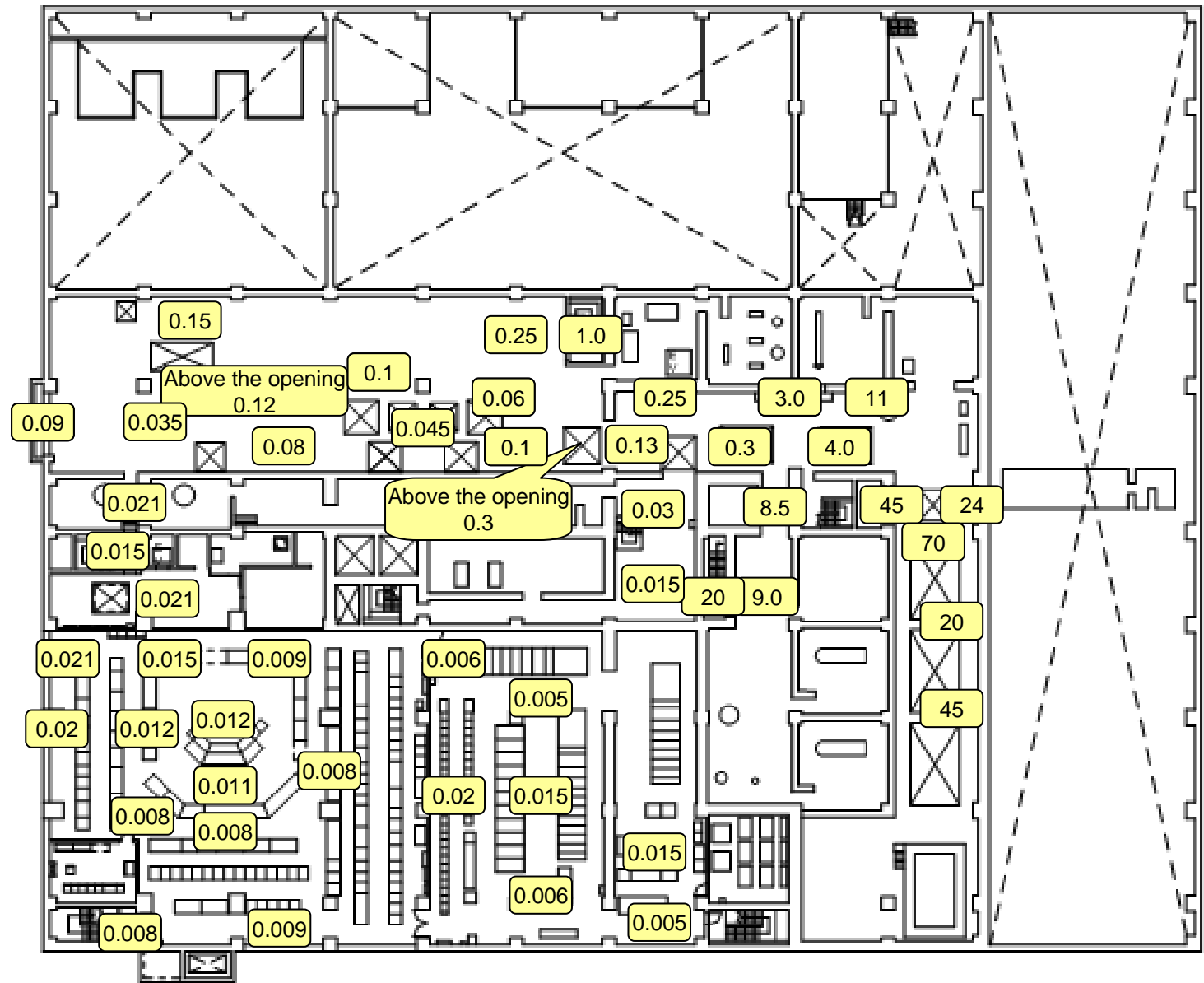

Process Main Building 4F

Unit: mSv/h

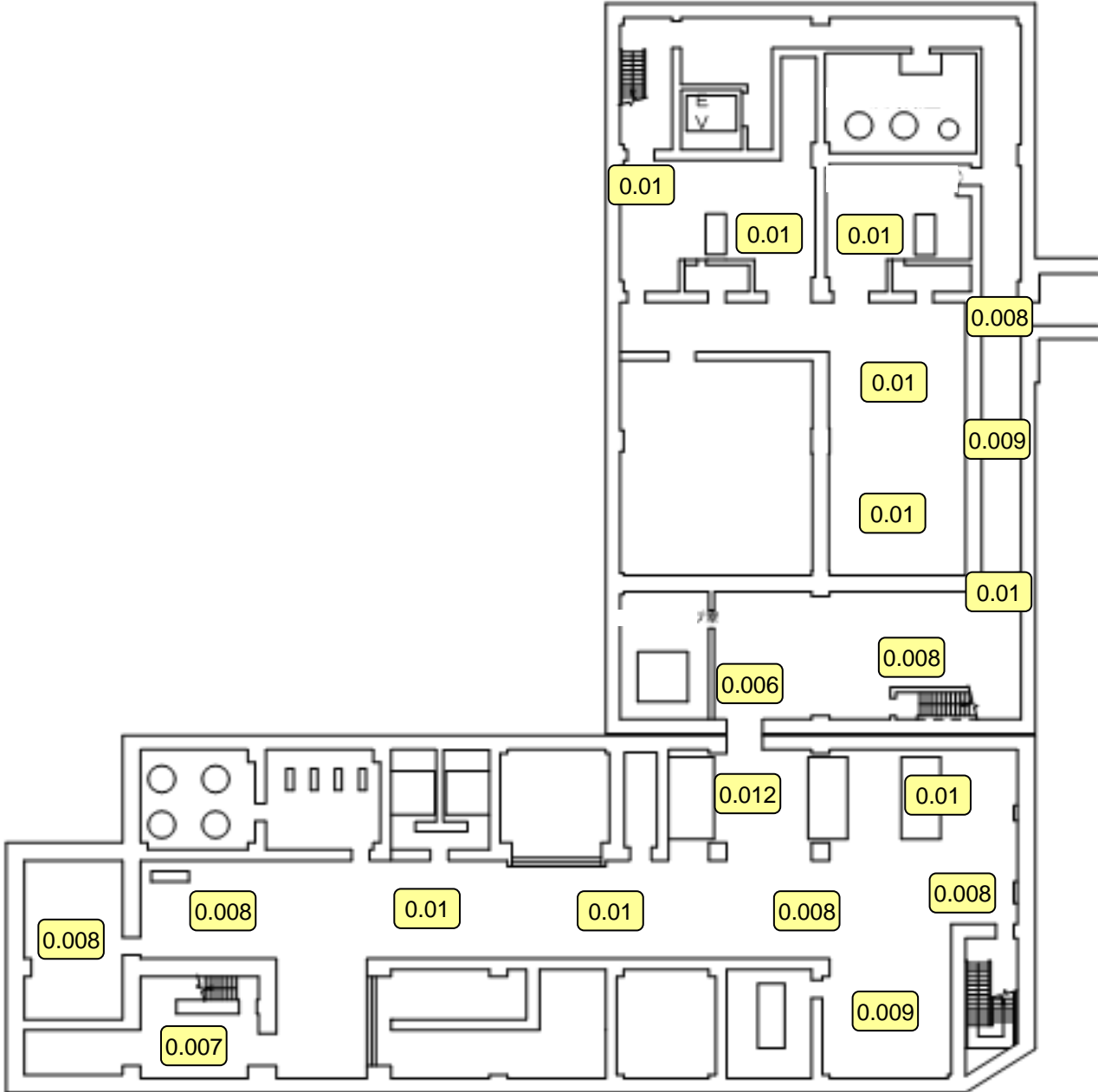

Incineration Workshop Building B1F

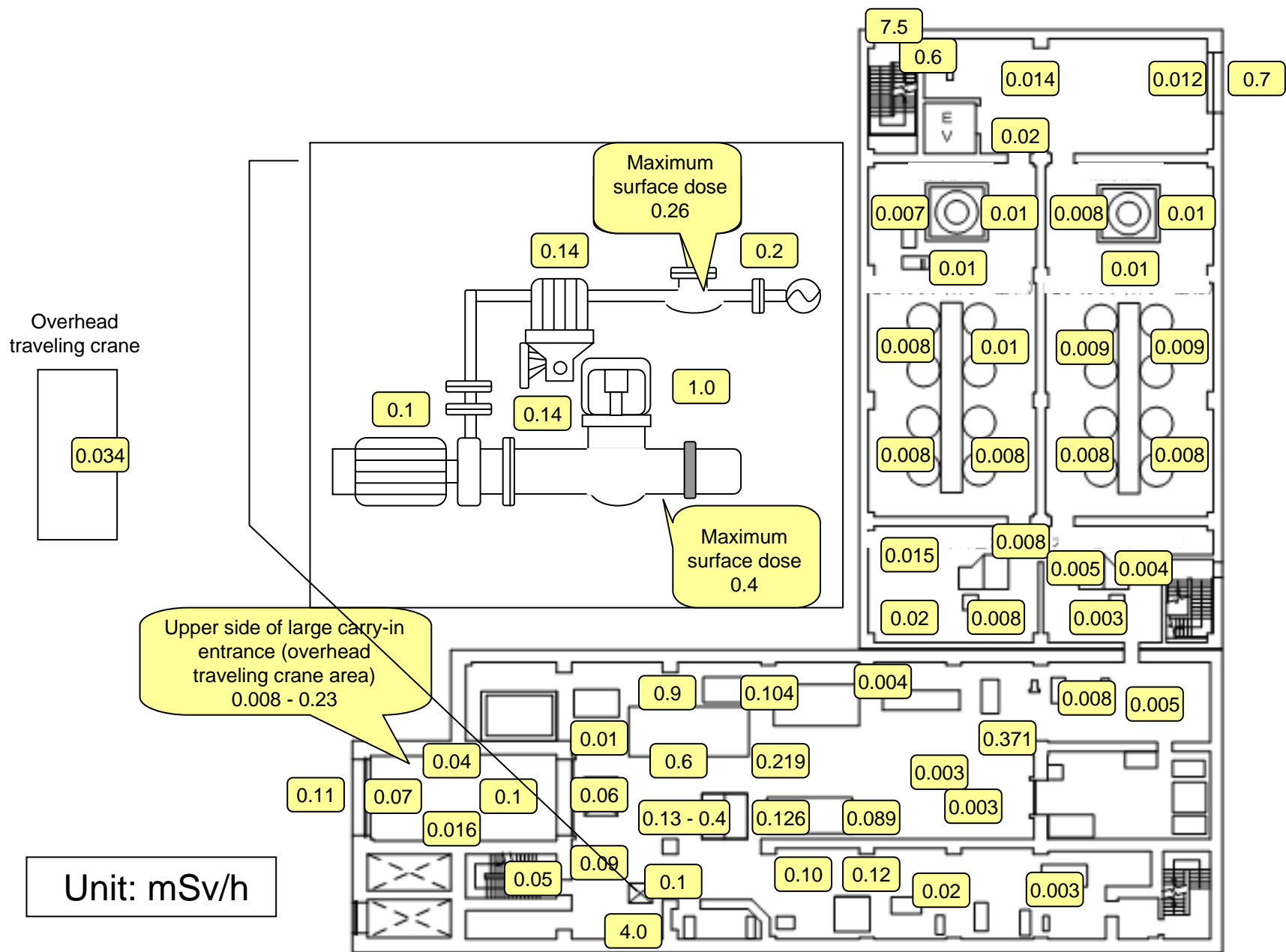

Incineration Workshop Building 1F

Unit: mSv/h

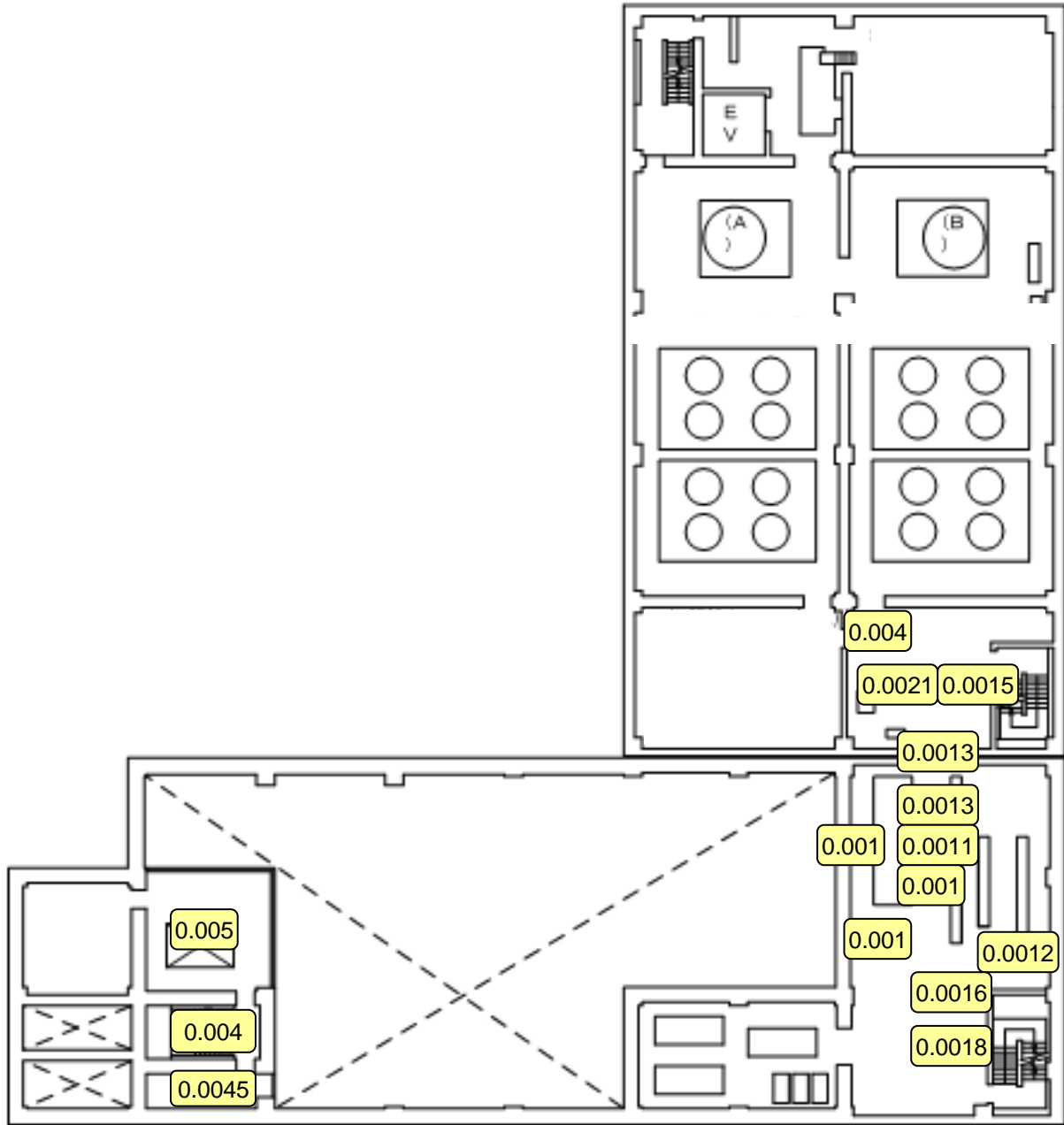

Incineration Workshop Building 2F

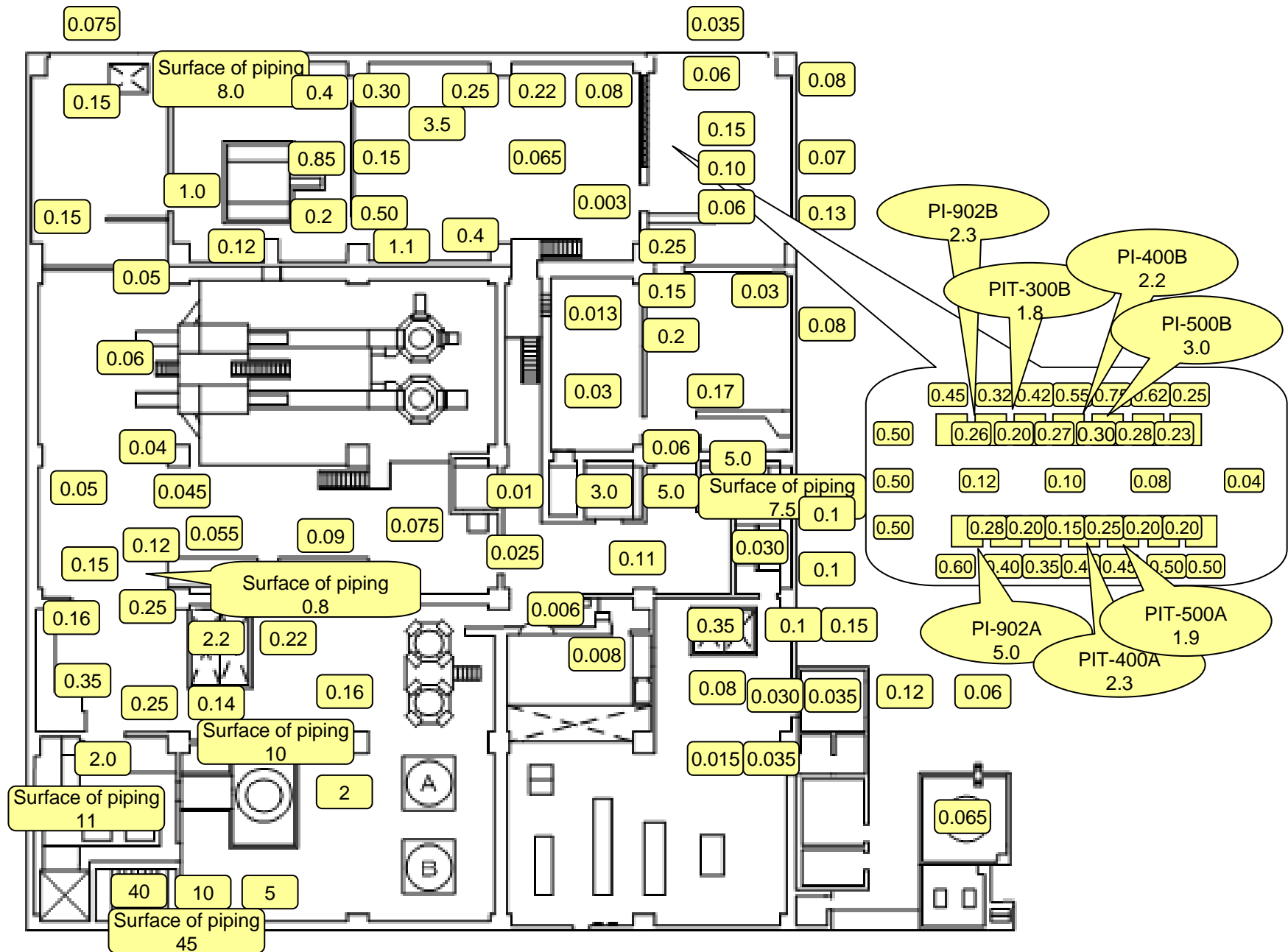

Miscellaneous Solid Waste Volume Reduction Treatment Building 1F

Unit: mSv/h

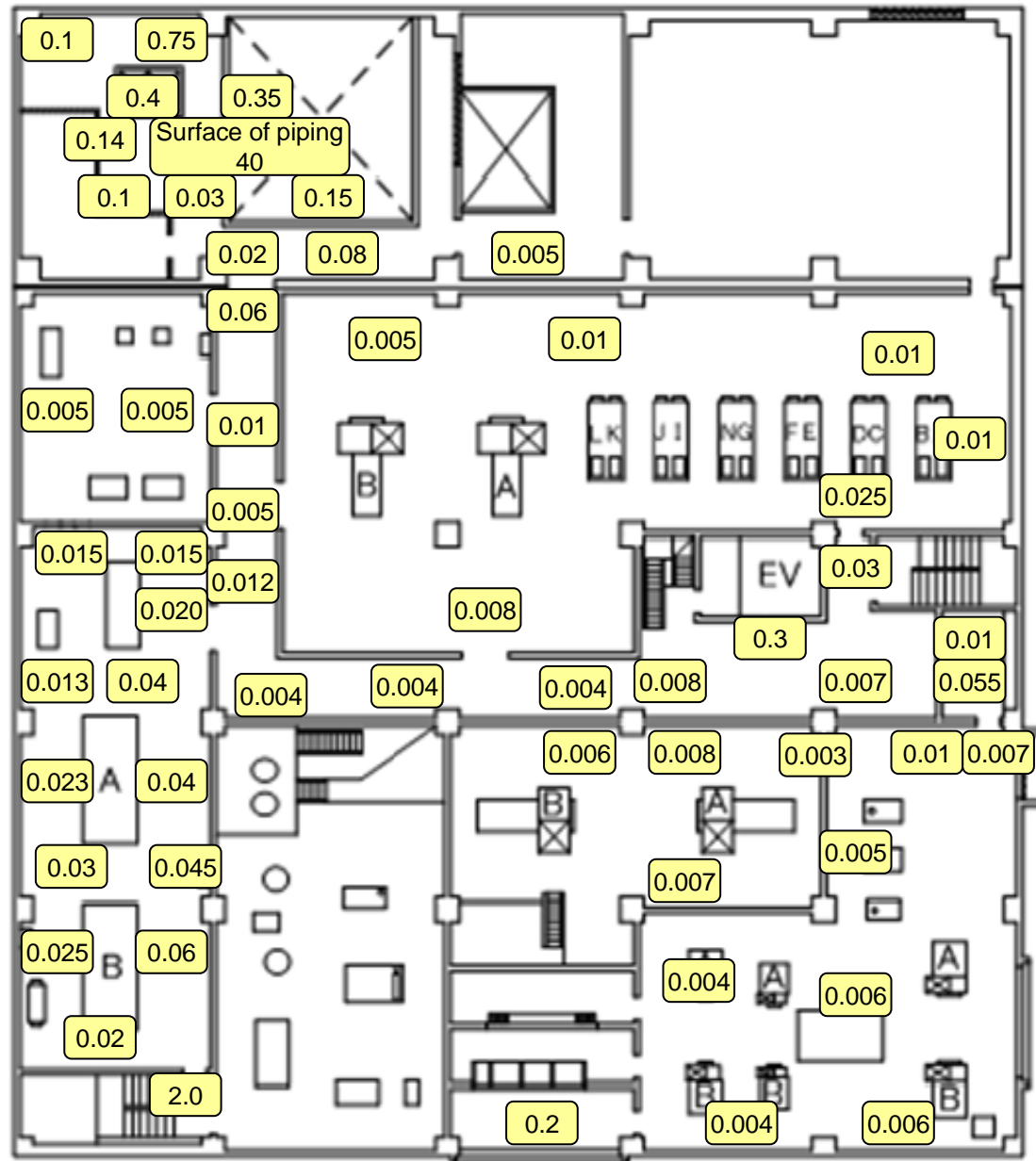

Miscellaneous Solid Waste Volume Reduction Treatment Building 2F

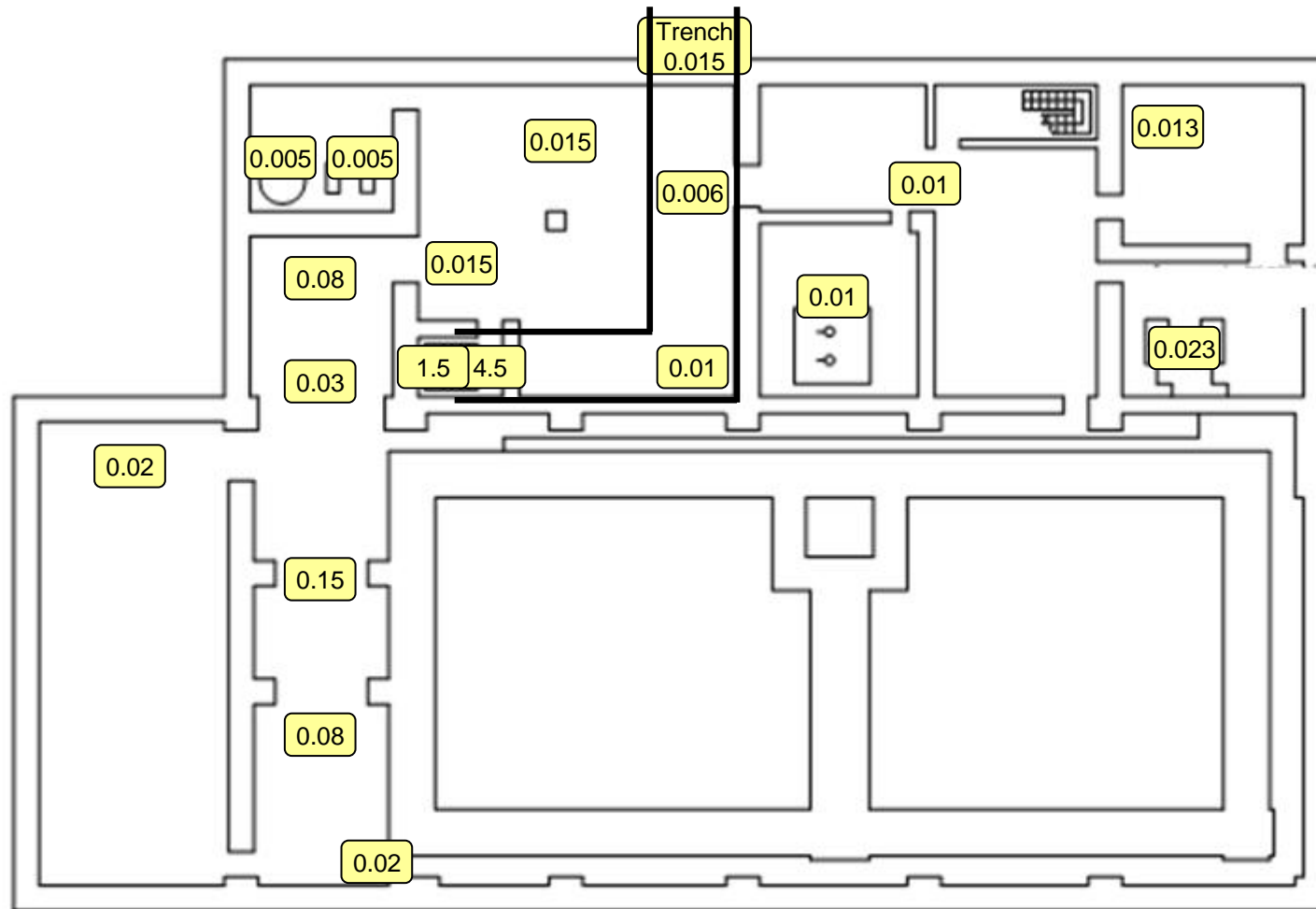

Unit: mSv/h

Site Bunker Building B1F

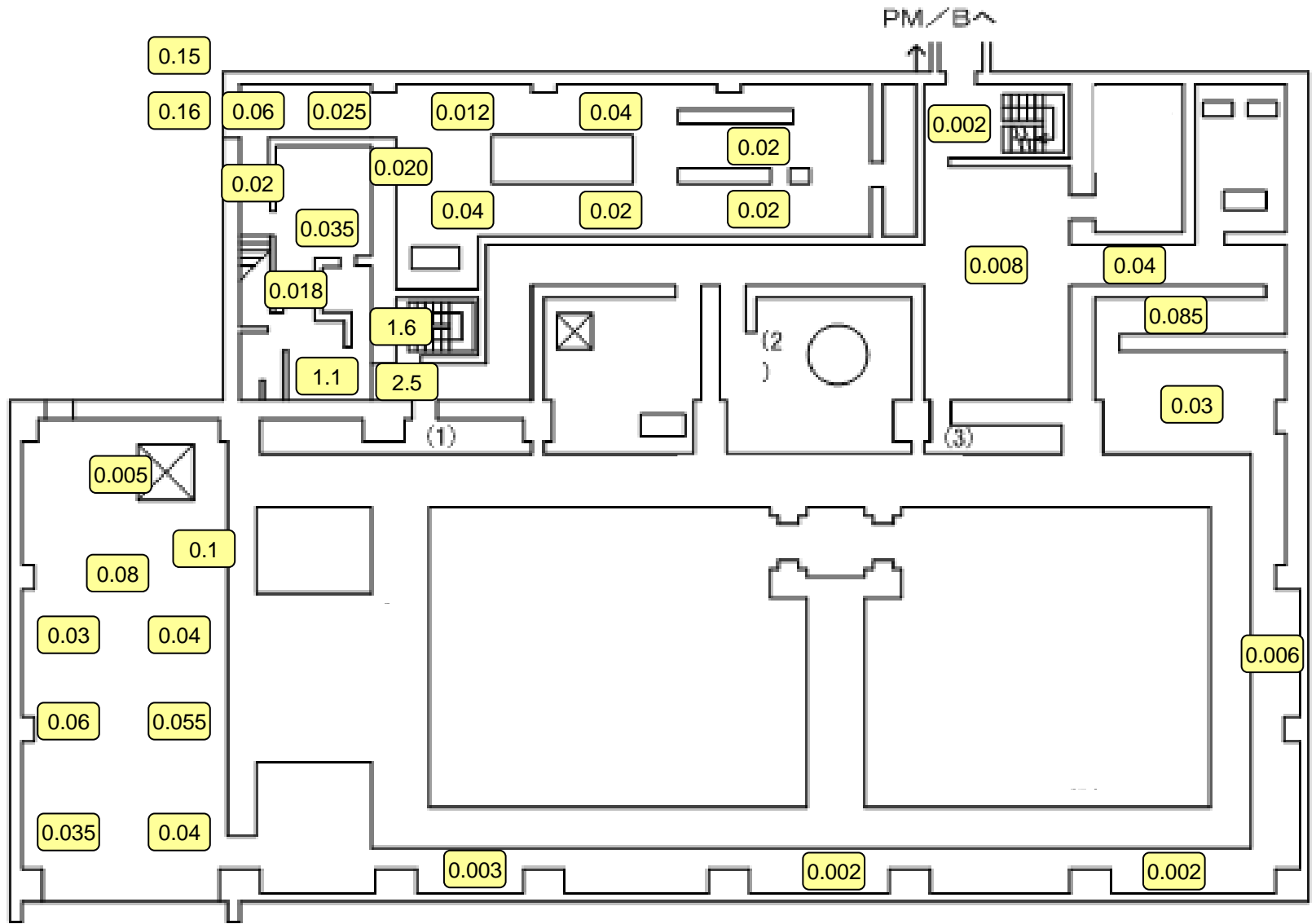

Unit: mSv/h

Site Bunker Building 1F

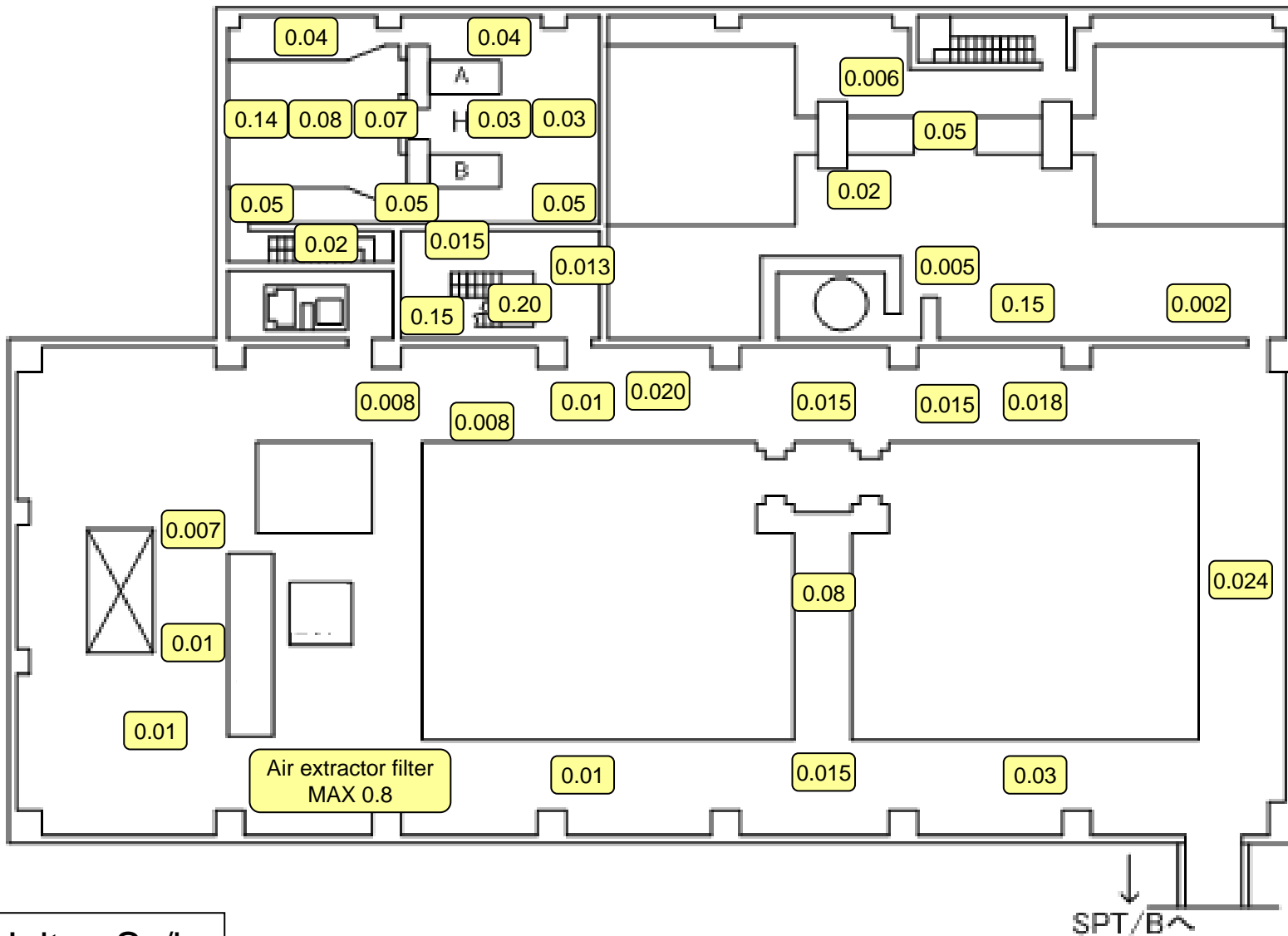

Site Bunker Building 2F

B1F

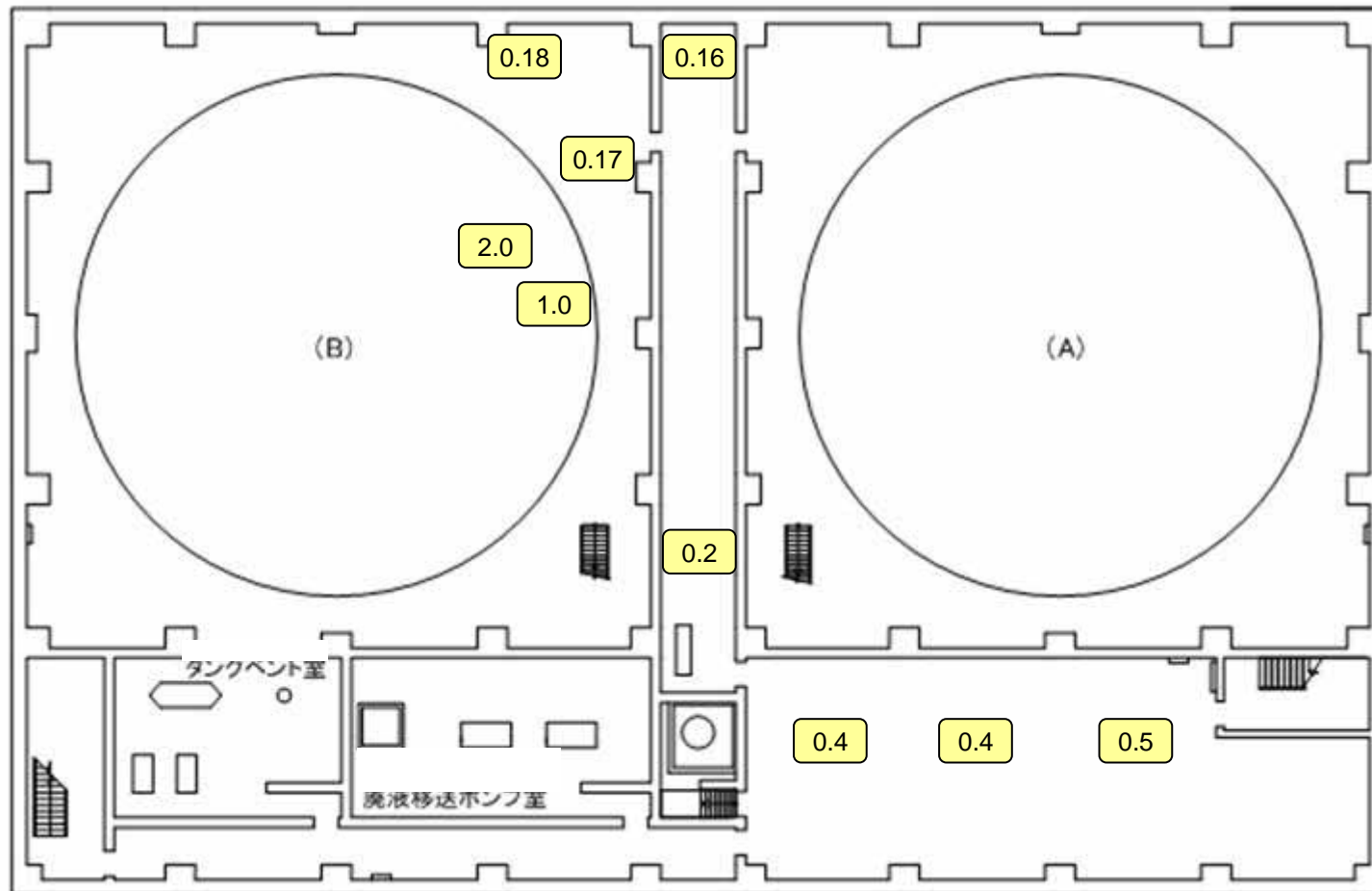

Unit: mSv/h

Suppression Pool Water Surge-Tank Building B1F

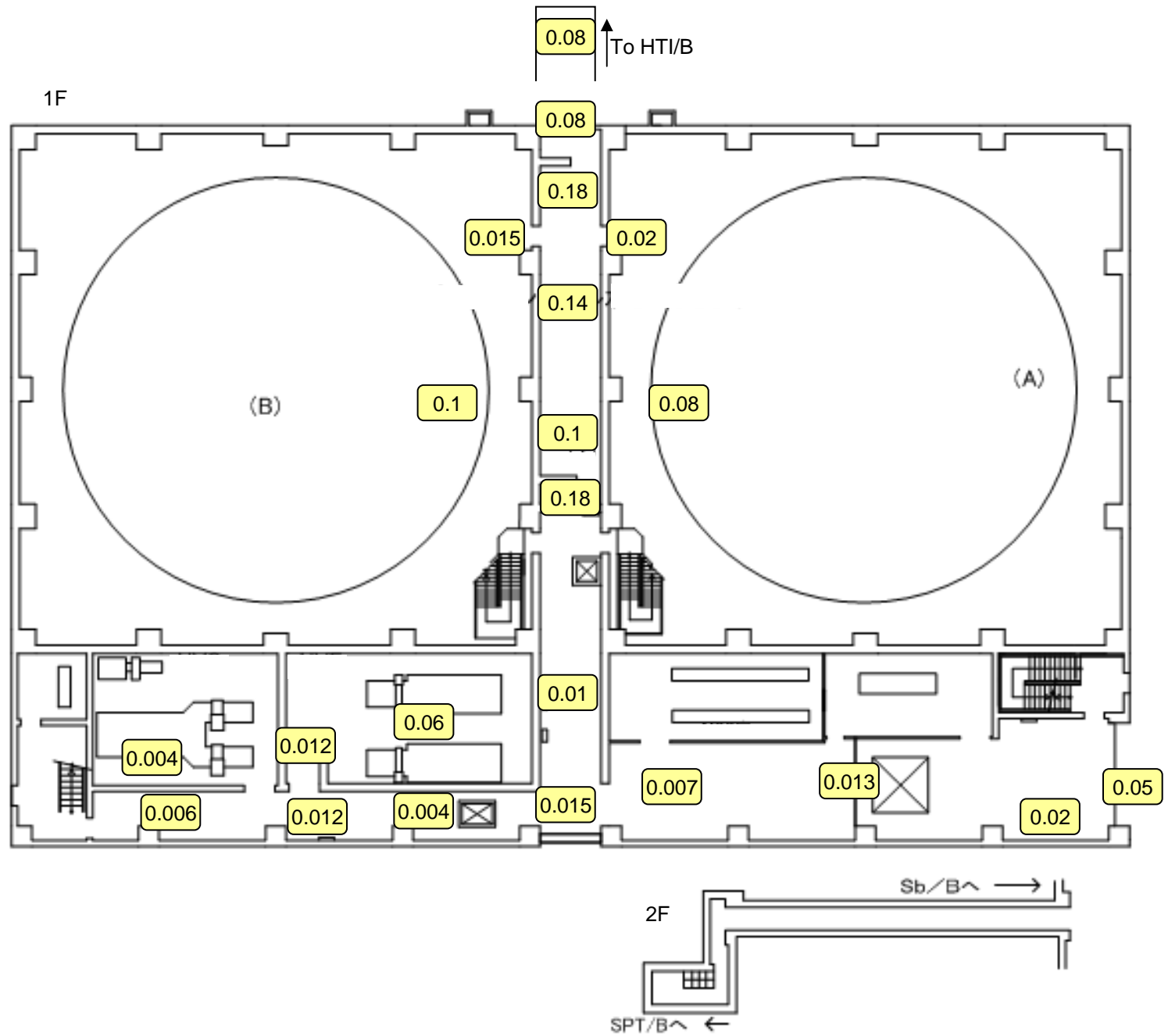

Unit: mSv/h

Suppression Pool Water Surge-Tank Building 1F

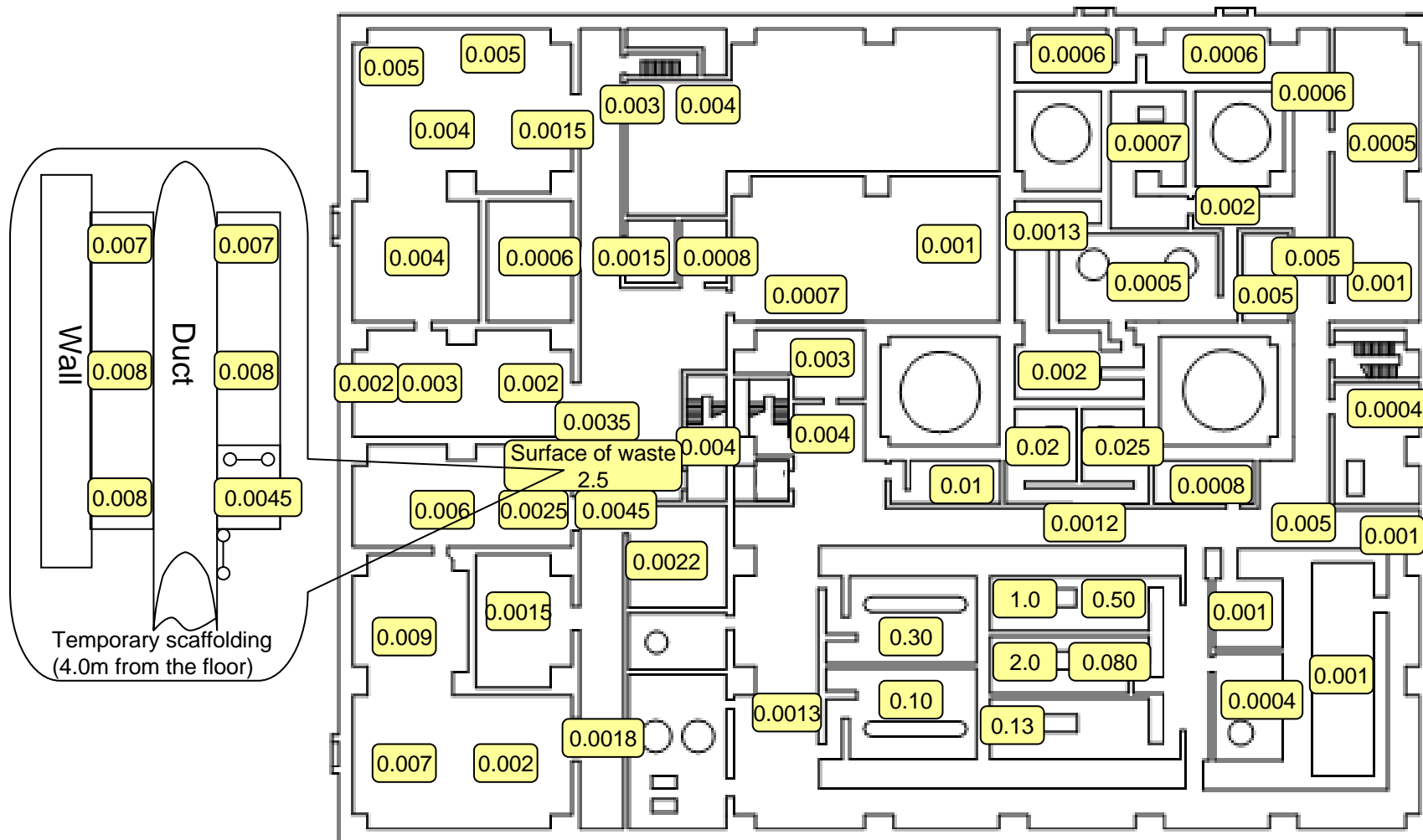

Unit: mSv/h

Auxiliary Operation Shared Facility B1F

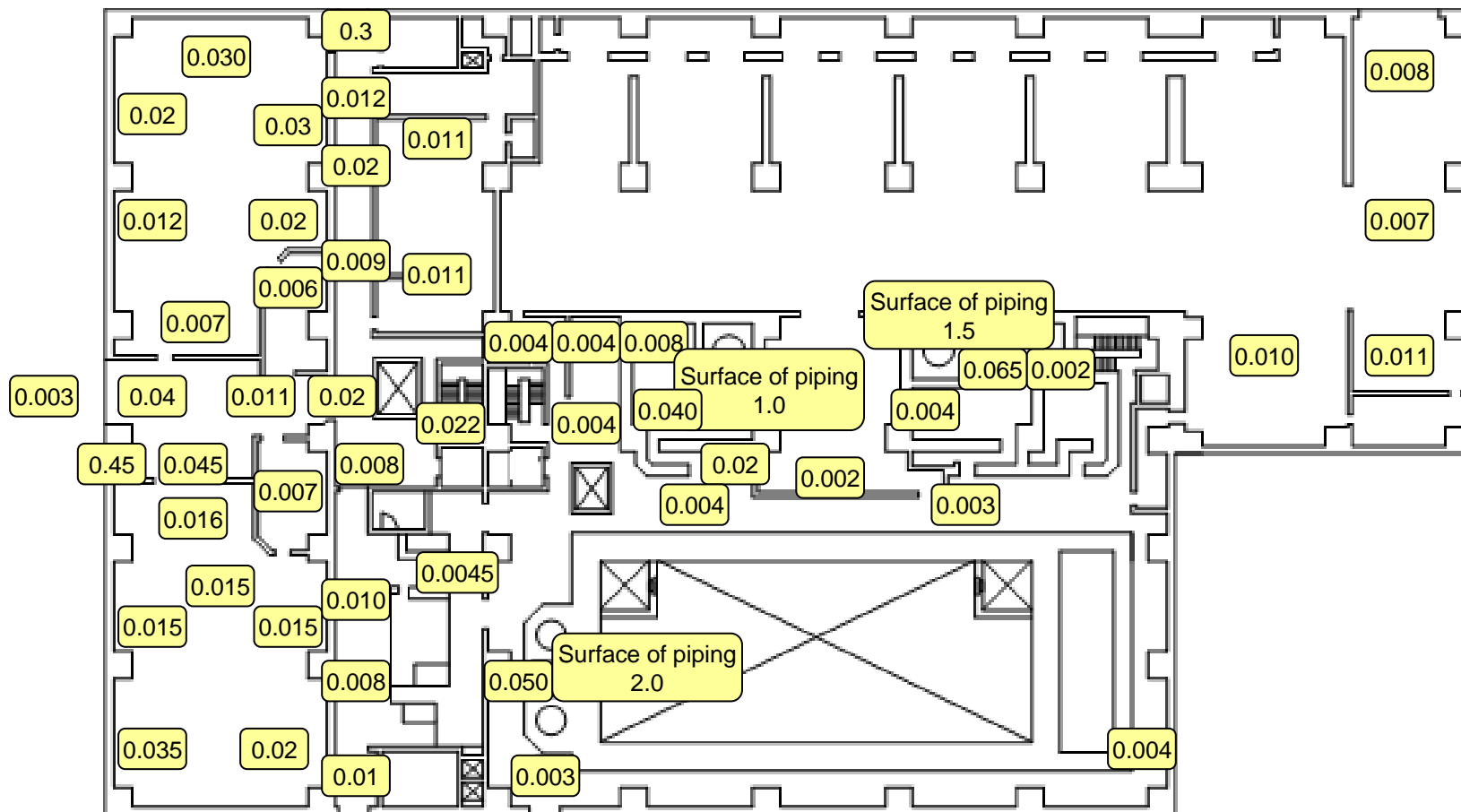

Unit: mSv/h

Auxiliary Operation Shared Facility 1F

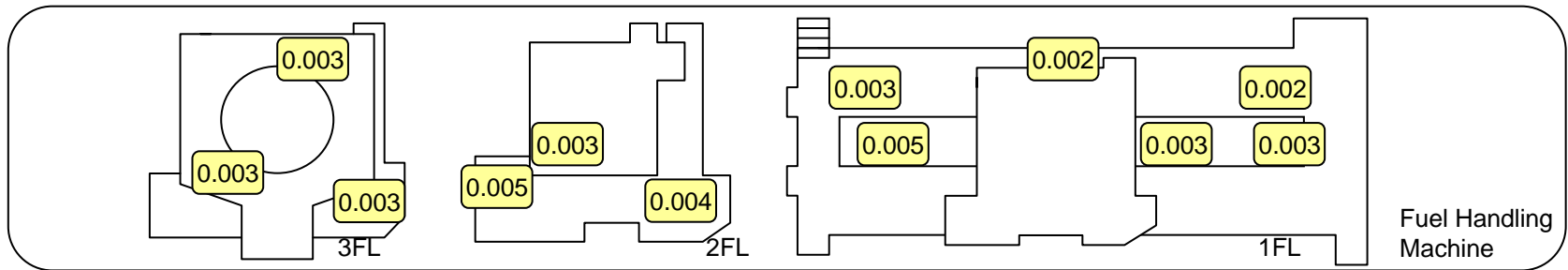

Fuel Handling Machine

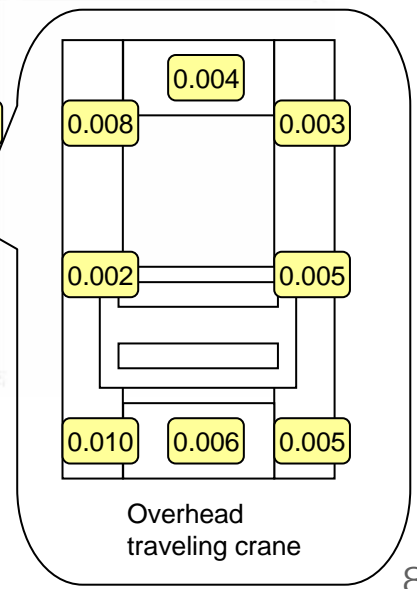
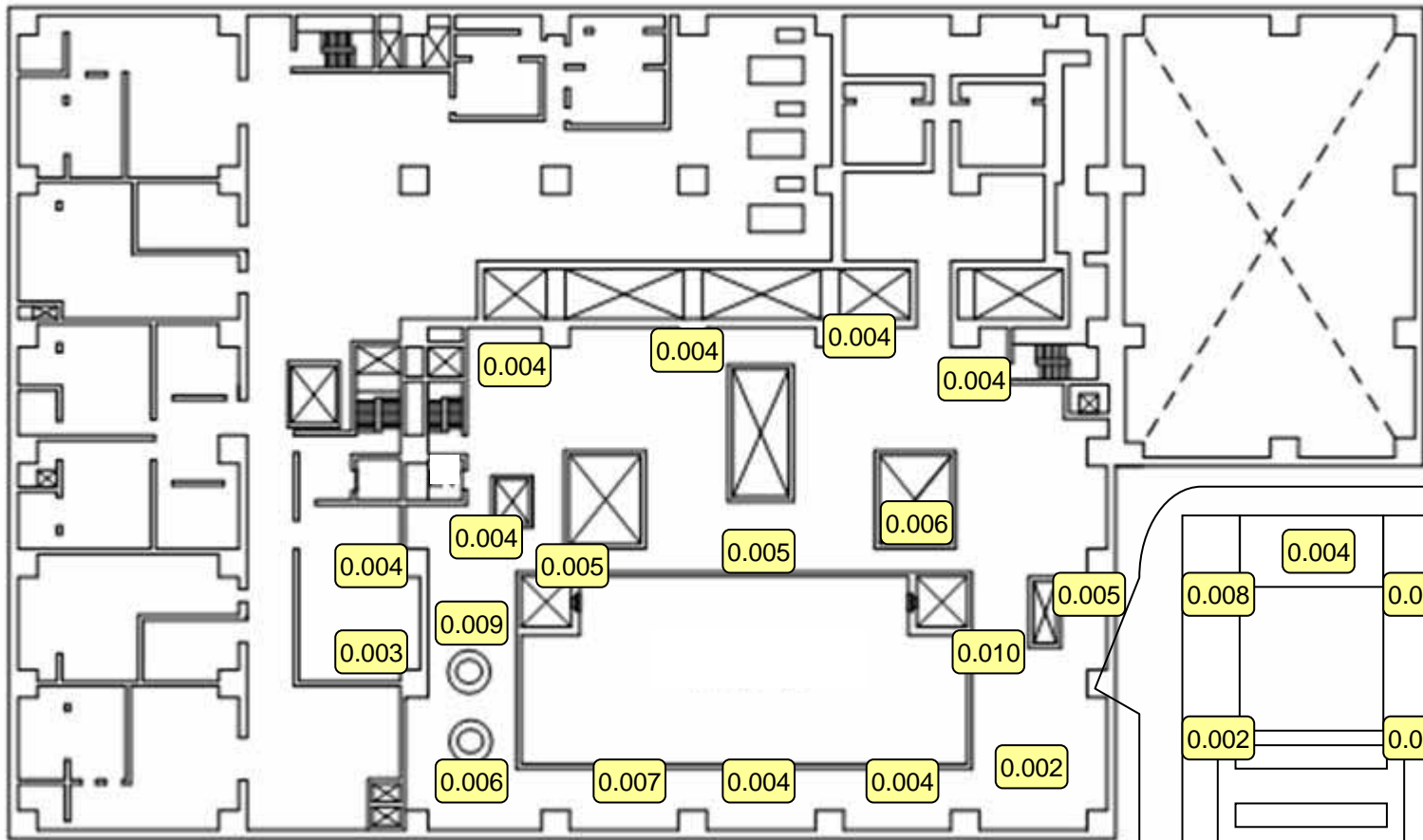

Overhead traveling crane

Unit: mSv/h

Auxiliary Operation Shared Facility 3F