

**Fukushima Daiichi Nuclear Power Station Unit No.1**

**Report on Earthquake Response Analysis of the Reactor Building,  
Important Equipment and Piping System for Seismic Safety using  
Recorded Seismic Data of the Tohoku-Chihou-Taiheiyo-Oki  
Earthquake in the Year 2011**

**July 28, 2011**

**Tokyo Electric Power Company**

- 1. Preface**
- 2. Basic Principle of Impact Assessment**
- 3. Impact Assessment on Reactor Building**
  - 3.1 Outline of the Reactor Building**
  - 3.2 Earthquake Observation Record at Reactor Building**
  - 3.3 Principle of Earthquake Response Analysis**
  - 3.4 Earthquake Response Analysis Model**
  - 3.5 Result of Impact Assessment**
- 4. Assessment of Impact on the Important Equipment and Piping System for Seismic Safety**
  - 4.1 Principle of Impact Assessment**
  - 4.2 Principle of Earthquake Response Analysis of Combined Large Equipment**
  - 4.3 Method of Impact Assessment**
  - 4.4 Result of Impact Assessment**
- 5. Summary**

**Attachment-1 : Overview of Assessment of Seismic Safety**

**Supplementary Document : Sharp Peak on Short Period Side of Floor Response Spectrum in Simulation Analysis of Vertical Direction of Reactor Building**

**Reference-1: Maximum Acceleration Value in the Seismic Data Recorded at the Reactor Building Base Mat of Fukushima Daiichi Nuclear Power Station**

**Reference-2 : Comparison of the Observation Records Collected by the Seismometers Installed at the Reactor Building Base Mat of Unit 6**

**Reference-3: Part Where the Curvature in Elastic Response Analysis Exceeds the First Break Point on the Bending Skeleton Curve**

**Reference-4 : Comparison Between the Seismic Motion for Input of Earthquake Response Simulation and the Observed Record**

**Reference-5 : Comparison of Evaluation Results for Major Facilities Against the Design Basis Ground Motions (Ss) and This Time Earthquake**

**Reference Attachment-1 : Function Confirmed Acceleration of Pump of Emergency Core Cooling System (ECCS)**

**Reference Attachment-2 : Seismic Safety Evaluation of Supporting Legs for the Suppression Chamber**

## **1. Preface**

This report summarizes the earthquake response analysis result of the Unit 1 Reactor Building ("R/B"), Fukushima Daiichi Nuclear Power Station and the earthquake response analysis result of R/B and other major equipments such as Primary Containment Vessel, Reactor Pressure Vessel, etc. further to "Regarding the Action Based on the Results of the Analysis of Seismic Data Observed at Fukushima Daiichi and Daini Nuclear Power Stations at the Time of the 2011 Tohoku District-Off the Pacific Ocean Earthquake (Directions)" (May 16, 2011 Nuclear Number 6, May 18, 2011)

## **2. Basic Principle of Impact Assessment**

In this report, we conduct analytical evaluation based on the earthquake response analysis of the R/B from the record of Tohoku-Chihou-Taiheiyo-Oki Earthquake in order to evaluate the impact of the quake to the R/B and major equipments and piping important for seismic safety.

As for the evaluation of R/B, we will indicate the maximum response acceleration spectra and the maximum response on the shear skeleton curve from the earthquake response analysis result based on the observation record.

We conduct the impact assessment on important equipments and piping for seismic safety by comparing (i) the earthquake load from the earthquake response analysis of R/B and the earthquake response analysis of the package of R/B and large equipments such as Reactor and (ii) the earthquake load derived from the Design Basis Ground Motion Ss.

If the earthquake load derived from this earthquake response analysis is higher than the earthquake load derived from the Design Basis Ground Motion Ss, we will evaluate major facilities which have important function for seismic safety.

### 3. Impact Assessment on Reactor Building

#### 3.1 Outline of the Reactor Building

R/B of Unit 1, Fukushima Daiichi Nuclear Power Station consists of five floors over ground part and one floor basement, mainly made of reinforced concrete. The upper part on the ground (over the fuel replacement floor of O.P. +38.90 m) and the roof are steel structures (truss structure). R/B's floor plan is as Figure 3.1.1 and vertical drawing is as Figure 3.1.2.

R/B consists of Reactor Ridge and Auxiliaries Ridge. Both are integrally constructed on the same base mat. The floors are square-shaped with 41.56 m \*1 (north-south direction) ×41.56 m \*1 (east-west direction) for the basement, square-shaped with 41.56 m \*1 (north-south direction) ×41.56 m \*1 (east-west direction) for 1F and 2F over the ground, and rectangle-shaped with 41.56 m \*1 (north-south direction) ×31.42 m \*1 (east-west direction) for 3F, 4F and 5F. The height from the bottom of the base mat is 58.35 m. The height from the ground level is 44.35 m. R/B is structurally independent from neighboring buildings.

The foundation of R/B is mat foundation with the thickness of 2.77 m. This is located on the mudstone layer at Neogene as the supporting bedrock.

Primary Containment Vessel containing the Reactor Pressure Vessel is located at the center of the R/B. The primary shielding wall made of reinforced concrete surrounding the PCV is cylindrical form in the upper section, cone-trapezoidal form in the middle section, cylindrical form in the lower section, and fixed to the base mat.

\*1 : the size of the R/B is measured on the outside of the wall

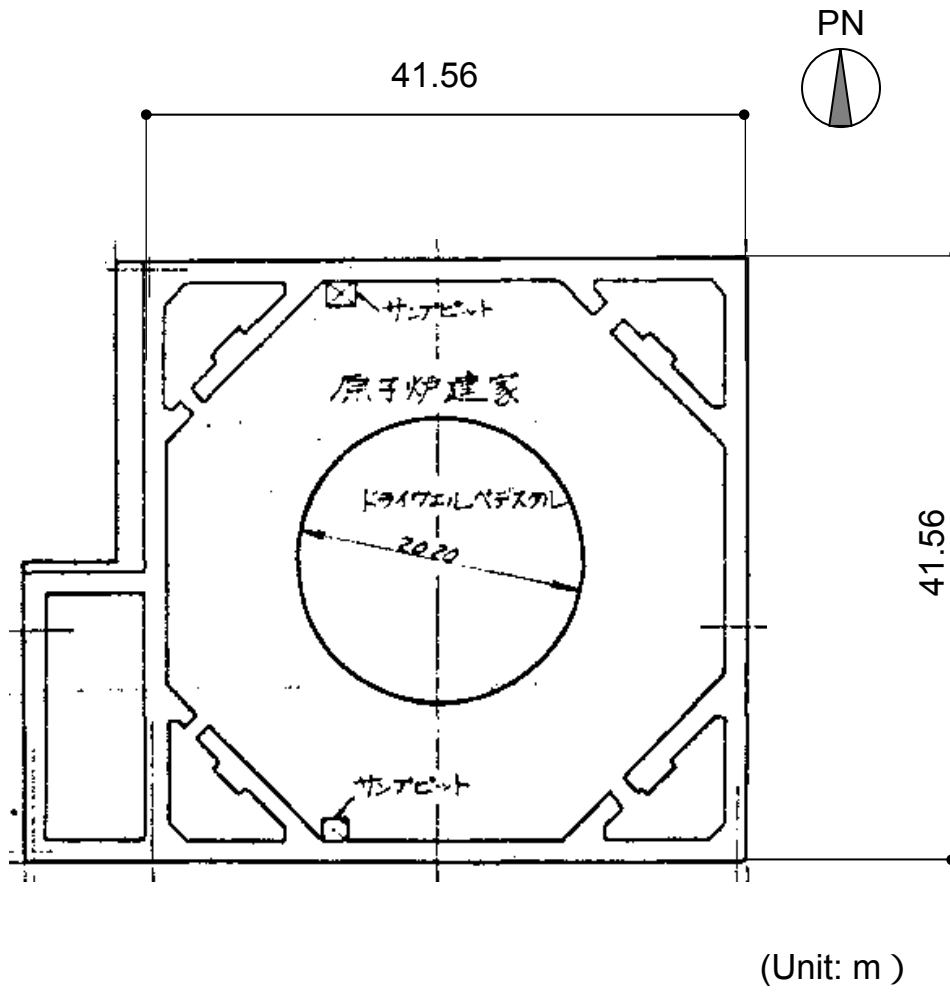
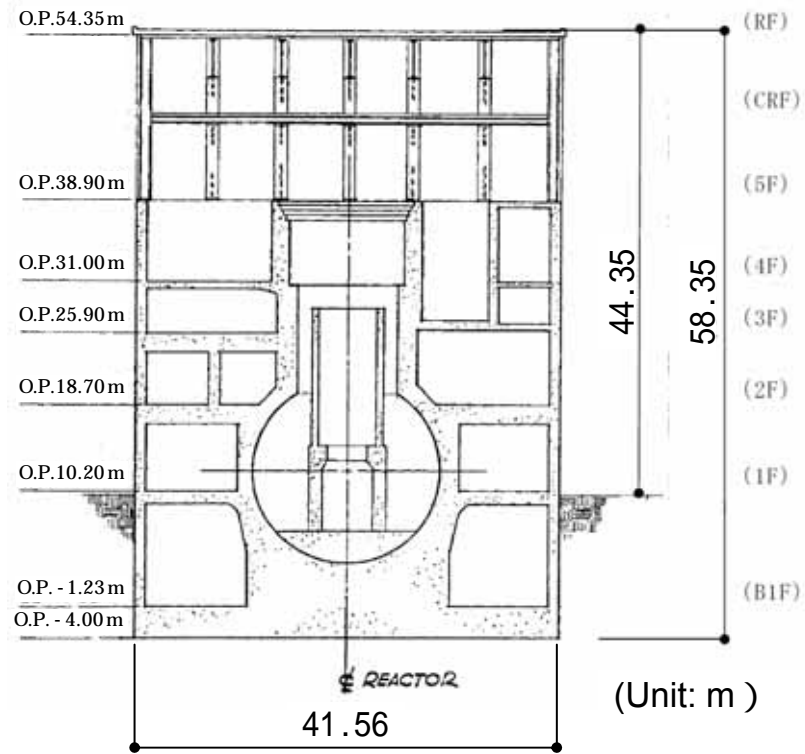
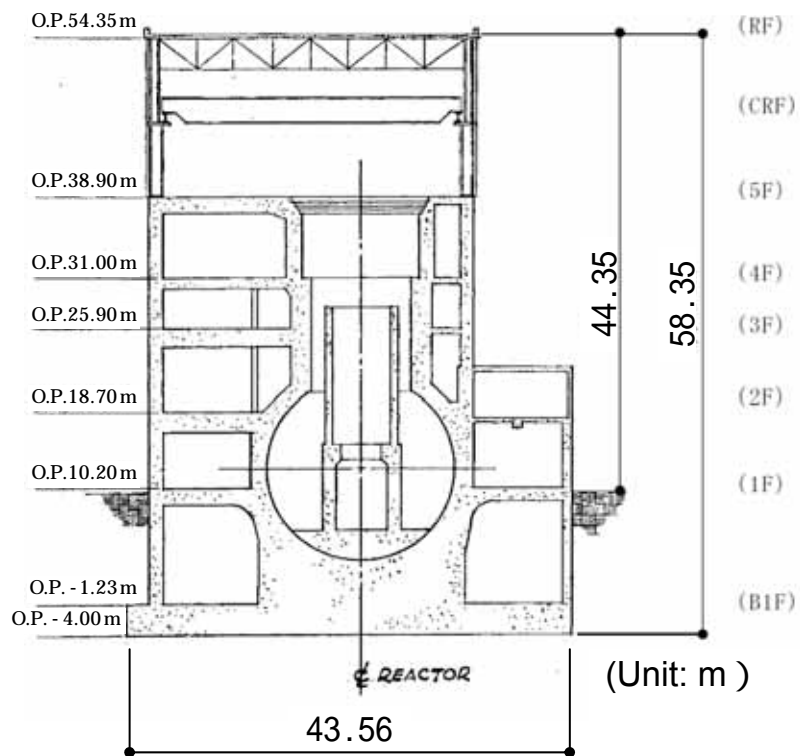

Figure 3.1.1: Floor Plan of R/B



(a) North-south Direction



(b) East-west Direction

Figure 3.1.2: Cross-section Drawing of Reactor Building



### **3.2 Earthquake Observation Record at Reactor Building**

The locations of earthquake observation points in R/B are shown in Figure 3.2.1. The acceleration recorded at earthquake observation point (1-R2) B1F is as Figure 3.2.2.

We could not get the observation record on the 2F.

The observation record at 1-R2 terminated in 141 seconds after start of record. It is confirmed that the maximum acceleration at 1-R2 occurred within the range of the obtained time history data. (Reference-1)

By comparing the records between (i) two neighboring observation points with terminated records and (ii) a complete record at the Unit 6 R/B base mat, it is confirmed that the maximum acceleration and spectra are of similar range. (Reference-2)

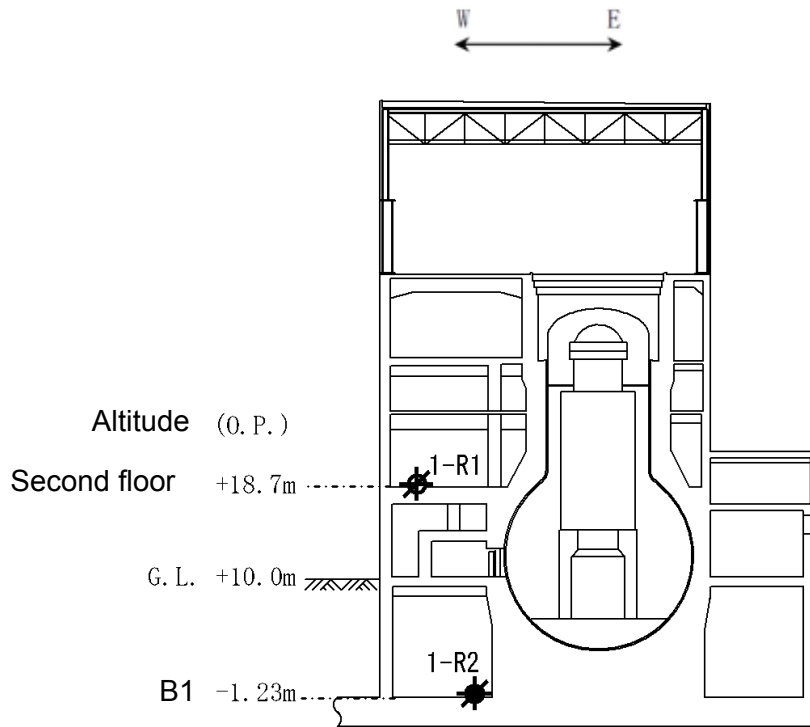
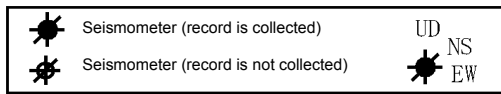

(a) Cross-section Drawing

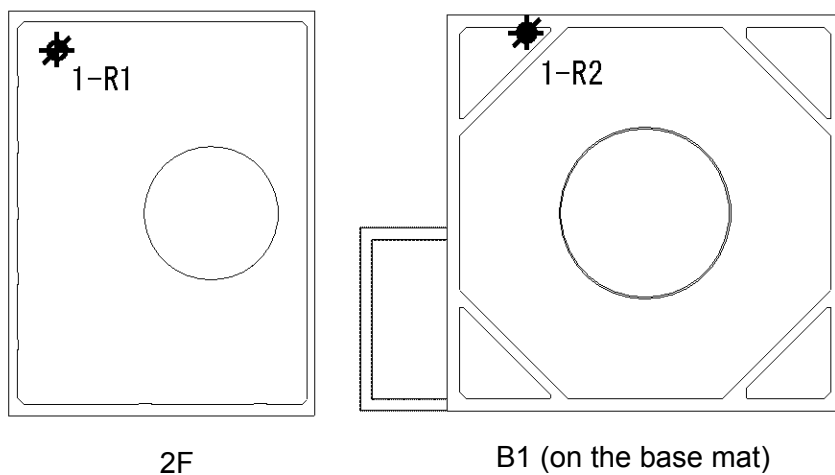

(b) Floor Plan

Figure 3.2.1 Locations of Earthquake Observation Points in R/B

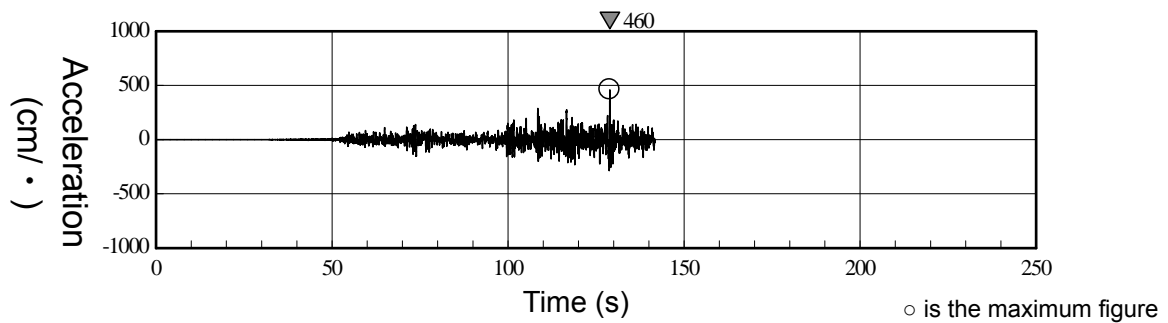

(a) North-south Direction

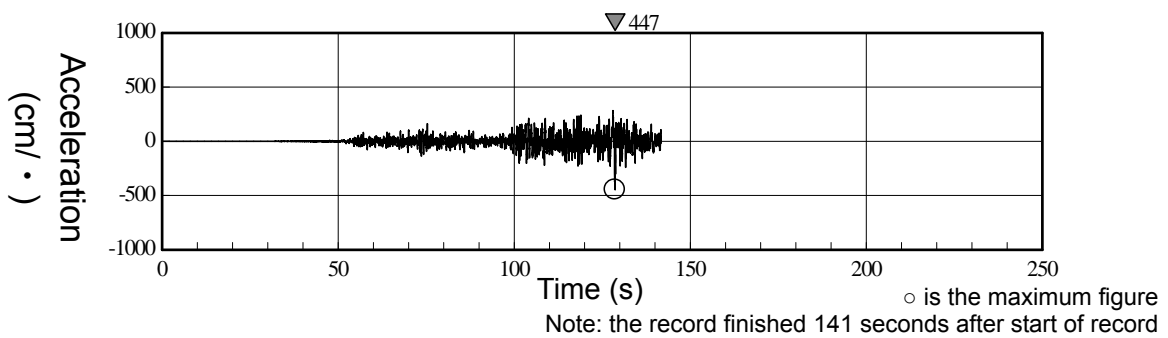

(b) East-west Direction

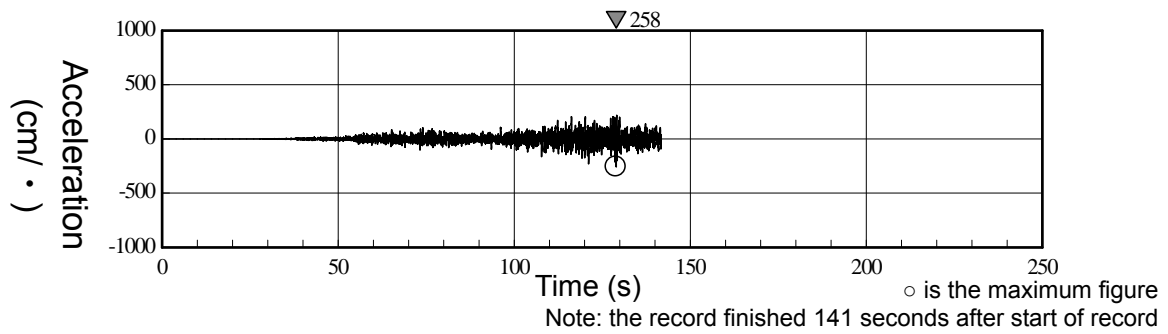

(c) Vertical Direction

Figure 3.2.2: Acceleration Recorded at R/B Base Mat  
( 1-R2 )

### 3.3 Principle of Earthquake Response Analysis

R/B's earthquake response analysis is by the elastic response analysis using the horizontal and vertical earthquake observation record recorded at base mat during the earthquake.

The response of each part of the R/B is by inputting the observation record at the base mat of R/B (Figure 3.2.2) to the base mat of the analytical model and calculating by the transfer functions from the base mat to each part of the R/B.

The outline of horizontal direction of the analysis is shown in Figure 3.3.1.

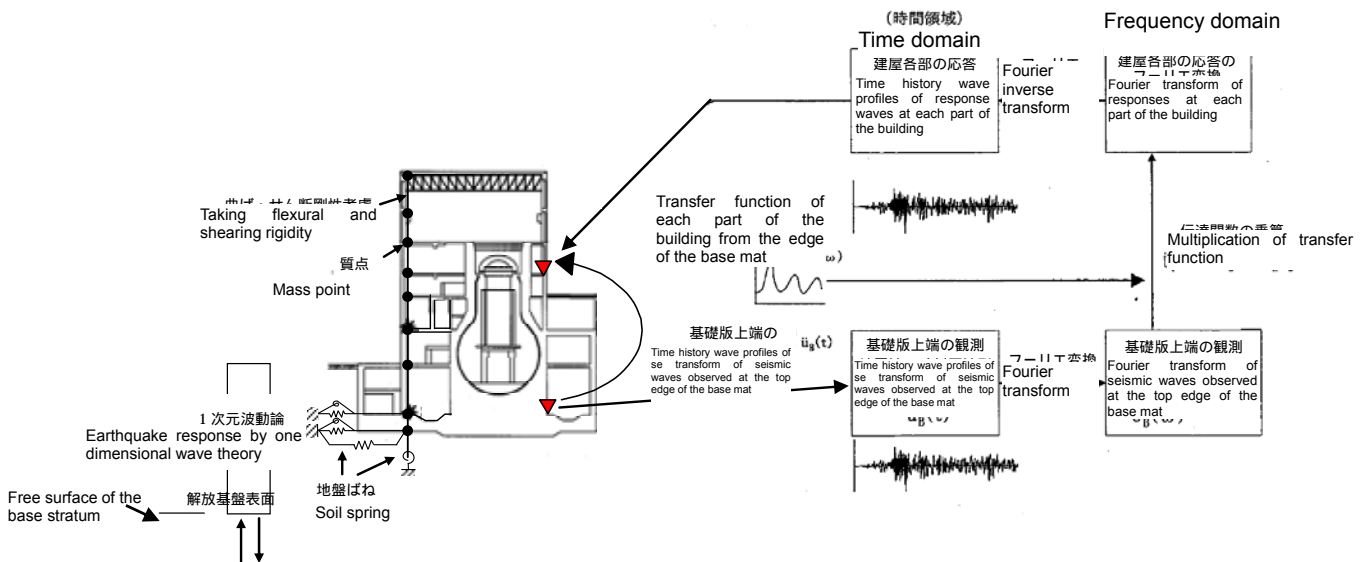

Figure 3.3.1: Earthquake Response Analysis - Horizontal

As to R/B of Unit 1, as the result of elastic response analysis – horizontal indicated that the curvature at part of the seismic wall was higher than the curvature at the first break point on the bending skeleton curve, we have conducted elastoplastic response analysis. (Reference-3)

In doing the elastoplastic response analysis, we set the ground response to be inputted to soil spring to make (i) the observation record at base mat and (ii) analysis results almost identical. (Comparison of

the observation record at the base and analysis results is in Reference-4.)

The outline of elastoplastic response analysis is in Figure 3.3.2.

As to the result of the earthquake response result, we indicate the maximum response acceleration spectra and maximum response figure on the shear skeleton curve.

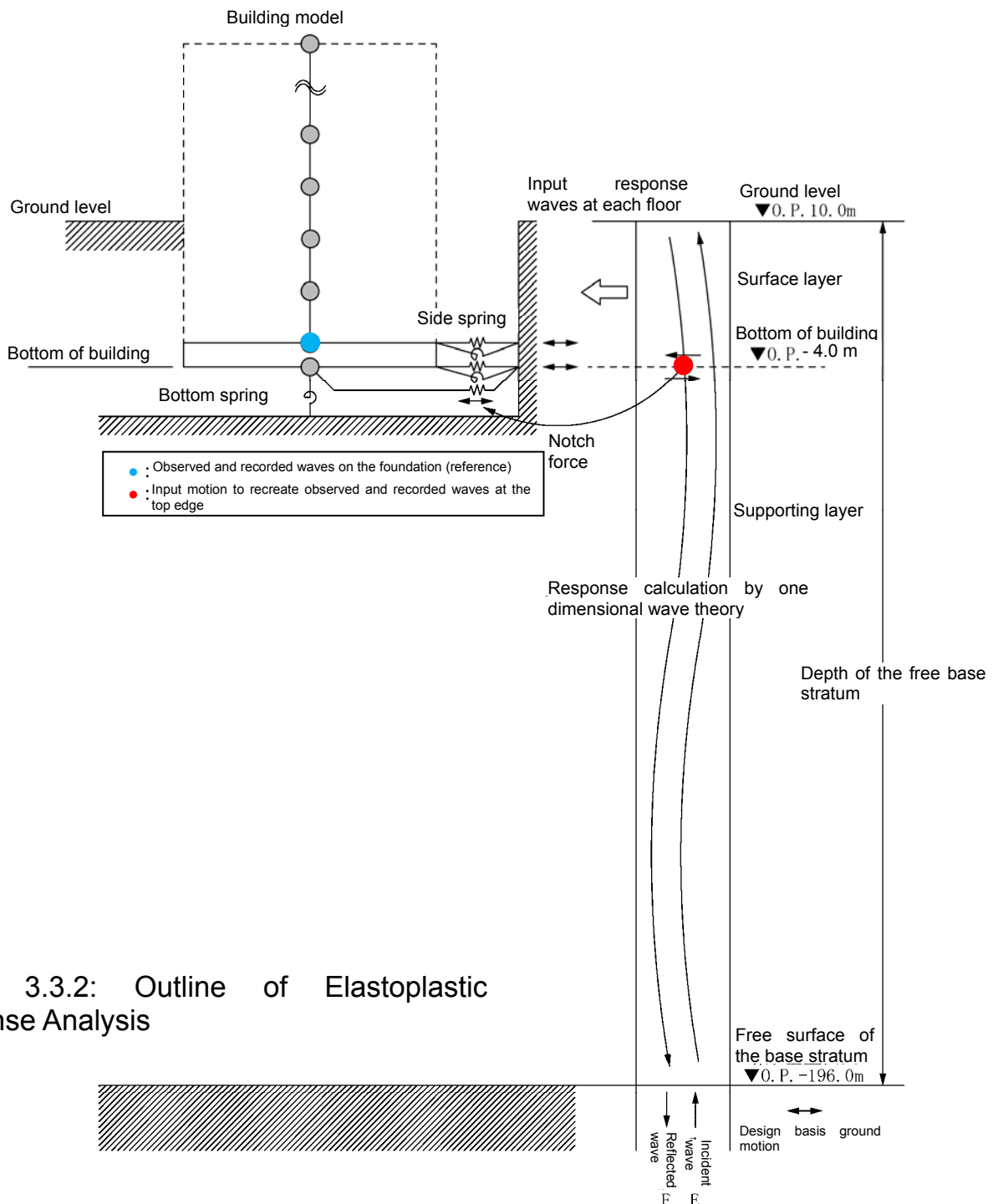

Figure 3.3.2: Outline of Elastoplastic Response Analysis

### **3.4 Earthquake Response Analysis Model**

#### **(1) Earthquake Response Analysis Model - Horizontal**

Taking account of the mutual interaction with ground, we use a mass system model incorporating flexural and shear rigidity. We do the modeling for north-south direction and east-west direction separately. The evaluation was done on the condition that the shear cross-section area was as same as the equivalent cross-section area made of concrete, because the upper part over O.P. 38.90 m is made of steel structure. The detail of the earthquake response analysis model is in Table 3.4.1.

We model the ground by horizontal layered soil model. As for foundation bottom soil spring, per "Technical Guidelines for Aseismic Design of Nuclear Power Plants Supplement Edition JEAG4601-1991" (hereinafter "JEAG4601-1991"), we did layered correction, calculated sway and rocking spring by vibration admittance theory and evaluated by approximation method. We take account of the geometric nonlinear by foundation uplift to the foundation bottom soil spring.

As for the side of R/B soil spring of the embedded part, we use the ground constant at the side point of the building and calculated the lateral and rotational spring per JEAG4601-1991 using Novak method and evaluate by approximation method.

Ground constants for the analysis are set as Table 3.4.2 taking account of the level of the shearing strain level at the time of the earthquake.

We set the hysteresis characteristics of R/B, from the horizontal cross-section shape using layer as a unit, direction by direction, per JEAG4601-1991.

We do the earthquake response analysis in horizontal direction by elastoplastic response analysis using the above plastic

memory hysteresis characteristics.

Table 3.4.1(1): Detail of Earthquake Response Analysis Model  
( North-south Direction )

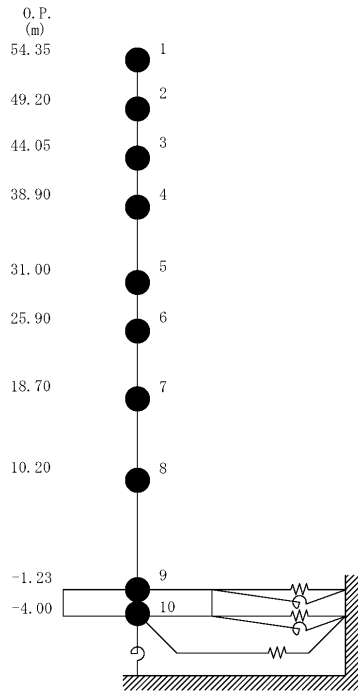

Mass point number	Weight of the mass point	Rotary inertia weight $I_G (\times 10^5 \text{ kN} \cdot \text{m}^2)$	Shear cross-section area $A_S (\text{m}^2)$	Cross-section secondary moment $I (\text{m}^4)$
1	7,990	11.47		
2	1,160	1.67	1.3 *1	
3	2,980	4.31	1.3 *1	
4	46,560	66.98	2.1 *1	
5	67,910	97.77	135.0	16,012
6	77,220	111.11	160.8	21,727
7	87,200	125.53	132.8	24,274
8	146,020	210.16	155.6	36,481
9	147,070	211.73	294.0	52,858
10	62,400	89.83	1,914.3	275,530
<b>Total</b>	<b>646,510</b>		<b>2.57 × 10<sup>7</sup> (kN/m<sup>2</sup>)</b>	

Young coefficient  $E_c$  2.57 × 10<sup>7</sup> (kN/m<sup>2</sup>)  
 Shear elasticity factor  $G$  1.07 × 10<sup>7</sup> (kN/m<sup>2</sup>)  
 Poisson ratio 0.20  
 Damping  $h$  5 % (Steel frame 2 %)  
 Form of the foundation 41.56 m (NS direction) \* 43.56 m (EW direction)  
 \*1: It shows the equivalent concrete cross-section area.

Table 3.4.1(2): Detail of Earthquake Response Analysis Model  
( East-west Direction )

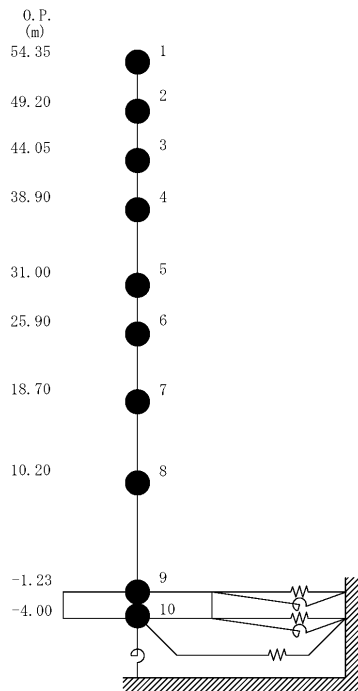

Mass point number	Weight of the mass point	Rotary inertia weight $I_G (\times 10^5 \text{ kN} \cdot \text{m}^2)$	Shear cross-section area $A_S (\text{m}^2)$	Cross-section secondary moment $I (\text{m}^4)$
1	7,990	6.57		
2	1,160	0.98	1.2 *1	
3	2,980	2.45	1.2 *1	
4	46,560	38.34	1.7 *1	
5	67,910	55.90	102.7	9,702
6	77,220	63.55	163.9	13,576
7	87,200	125.53	131.6	14,559
8	146,020	210.16	197.8	36,427
9	147,070	259.97	294.0	52,858
10	62,400	110.32	1,914.3	338,428
<b>Total</b>	<b>646,510</b>		<b>2.57 × 10<sup>7</sup> (kN/m<sup>2</sup>)</b>	

Young coefficient  $E_c$  2.57 × 10<sup>7</sup> (kN/m<sup>2</sup>)  
 Shear elasticity factor  $G$  1.07 × 10<sup>7</sup> (kN/m<sup>2</sup>)  
 Poisson ratio 0.20  
 Damping  $h$  5 % (Steel frame 2 %)  
 Form of the foundation 41.56 m (NS direction) \* 43.56 m (EW direction)  
 \*1: It shows the equivalent concrete cross-section area.



Table 3.4.2: Ground Constants for Analysis

Height O.P. (m)	Soil	Velocity of shear wave Vs (m/s)	Weight by unit volume $\gamma$ (kN/m <sup>3</sup> )	Poisson ratio $\nu$	Initial shear elasticity factor Go ( $\times 10^5$ kN/m <sup>2</sup> )	Stiffness degradation ratio G/Go	Damping factor h (%)
10.0	Sandstone	380	17.8	0.473	2.62	0.84	3
1.9		450	16.5	0.464	3.41	0.81	3
-10.0	Mudstone	500	17.1	0.455	4.36	0.81	3
-80.0		560	17.6	0.446	5.63	0.81	3
-108.0		600	17.8	0.442	6.53	0.81	3
-196.0		(Freedom foundation)	700	18.5	0.421	9.24	1.00

## **(2) Earthquake Response Analysis Model - Vertical**

We use the mass system model taking account of the axial rigidity of the seismic wall and the bending-shear rigidity of the roof truss as the earthquake response analysis model. Detail of the earthquake response analysis model-horizontal is as Table 3.4.3.

We model the ground by horizontal layered foundation model.

As for foundation bottom soil spring, similar to the evaluation of constants for sway and rocking spring constants, we did layered correction and then, calculated the vertical spring by vibration admittance theory and evaluate approximately.

As for constants for evaluation, we set our similar to figures for horizontal evaluation. Those are as Table 3.4.2.

The horizontal earthquake response analysis is by elastic response analysis.

Table 3.4.3: Detail of Earthquake Response Analysis Model  
( Horizontal Direction )

Building				Roof			
Mass point number	Weight of the mass point W (kN)	Axial cross-section area $A_N$ (m <sup>2</sup> )	Axial spring stiffness $K_A$ ( $\times 10^6$ kN/m )	Mass point number	Weight of the mass point W (kN)	Shear cross-section area $A_S$ ( $\times 10^{-2}$ m <sup>2</sup> )	Cross-section moment secondary $I$ (m <sup>4</sup> )
1	2,915			1	-		
2	1,160	0.710	0.28	11	1,450	6.90	0.791
3	2,980	0.720	0.29	12	1,450	4.66	0.791
4	46,560	0.940	0.37	13	1,450	3.56	0.791
5	67,910	151.1	4.92	14	725	3.56	0.791
6	77,220	205.0	10.33				
7	87,200	221.7	7.91				
8	146,020	301.0	9.10				
9	147,070	495.7	11.15				
10	62,400	1,914.3	177.61				
合計	646,510						

Concrete part  
 Young modulus  $E_C$   $2.57 \times 10^7$  ( kN/m<sup>2</sup> )  
 Shear elasticity factor  $G$   $1.07 \times 10^7$  ( kN/m<sup>2</sup> )  
 Poisson ratio, 0.20  
 Damping  $h$  5%

Steel-frame part  
 Young modulus  $E_S$   $2.05 \times 10^8$  ( kN/m<sup>2</sup> )  
 Shear elasticity factor  $G$   $7.90 \times 10^7$  ( kN/m<sup>2</sup> )  
 Poisson ratio 0.30  
 Damping  $h$  2%

Rotational constraining spring at the edge of truss  $K_\theta$   $1.01 \times 10^6$  ( kN·m/rad )  
 Form of the foundation 46.6m(NS direction) X 57.0m (EW direction)

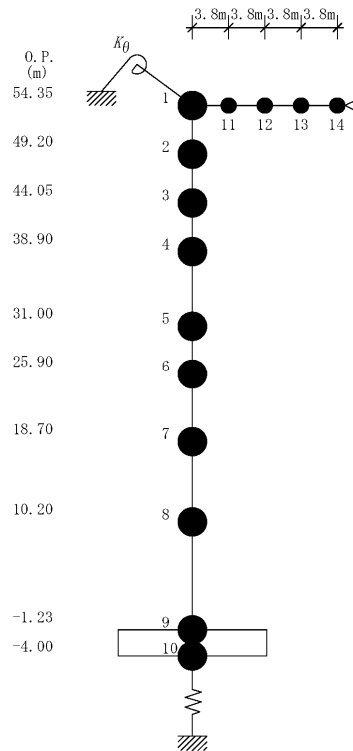

### **3.5 Result of Impact Assessment**

The maximum response acceleration spectra and the observation record are in Figure 3.5.1. A list of shear strain of the anti earthquake wall is in Table 3.5.1. The maximum response figure on the shear skeleton curve is in Figure 3.5.2.

The maximum shear strain of the anti earthquake wall is  $0.14 \times 10^{-3}$  (north-south direction, 1F). At all the anti earthquake walls, the stress and deformation are below the first break point.

Also, there is sufficient margin against the evaluation standard ( $2.0 \times 10^{-3}$ ) for the maximum shear strain of the anti earthquake wall further to the supplement to the “Regulatory Guide for Aseismic Design of Nuclear Power Reactor Facilities”.

Therefore, we estimate that the R/B maintained the required safety function when the earthquake occurred.

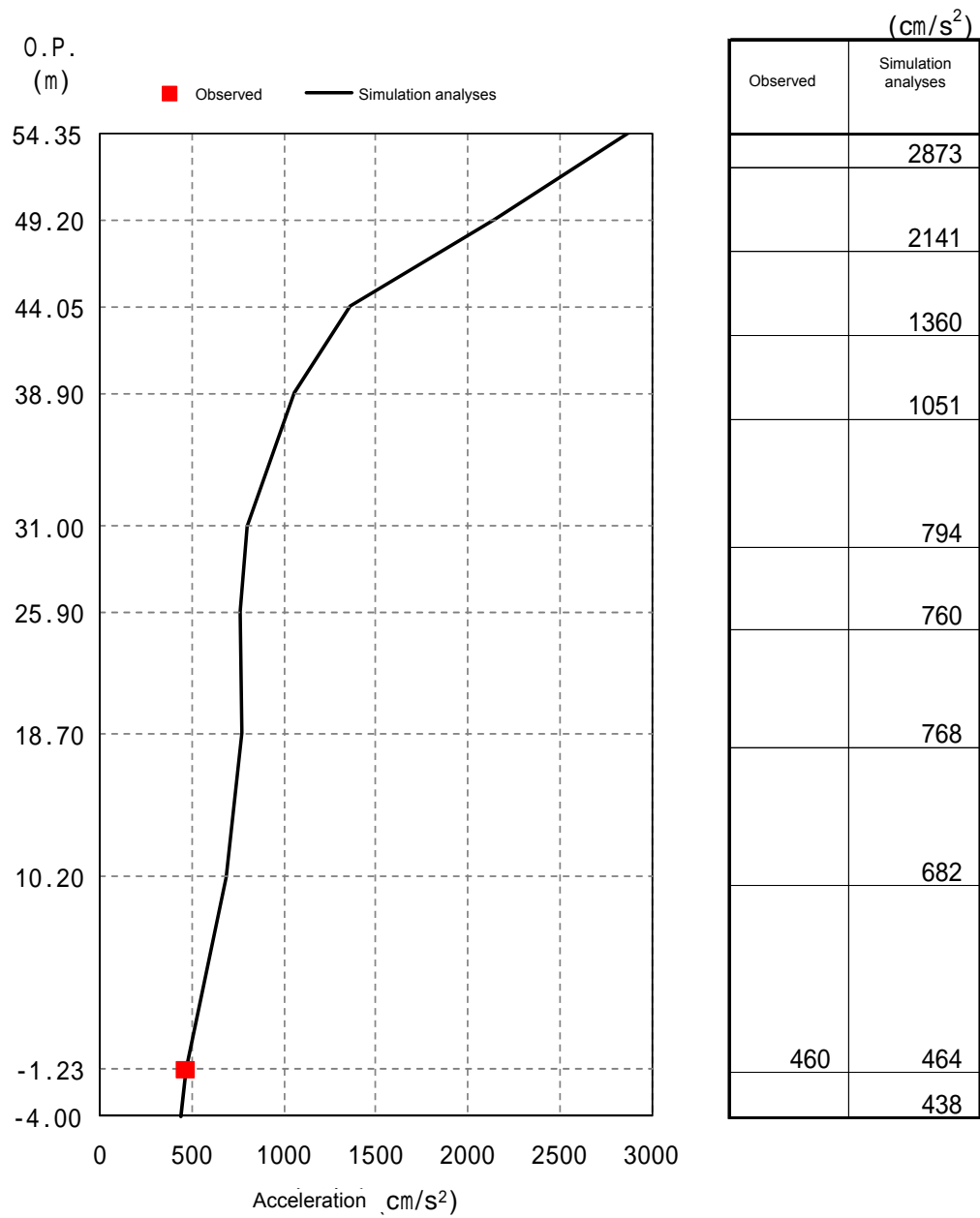

Figure 3.5.1(1): Maximum Response Acceleration (North-south)

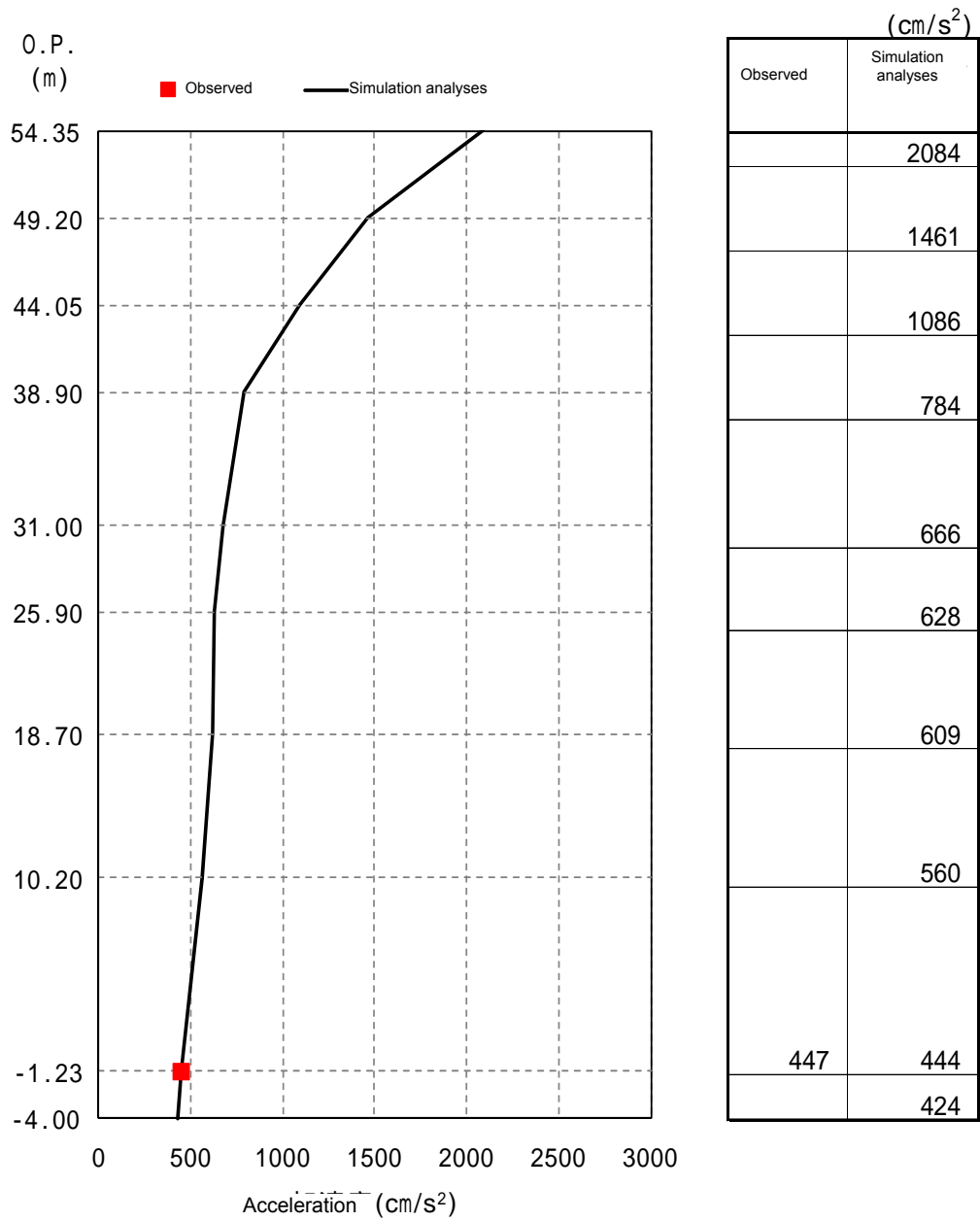
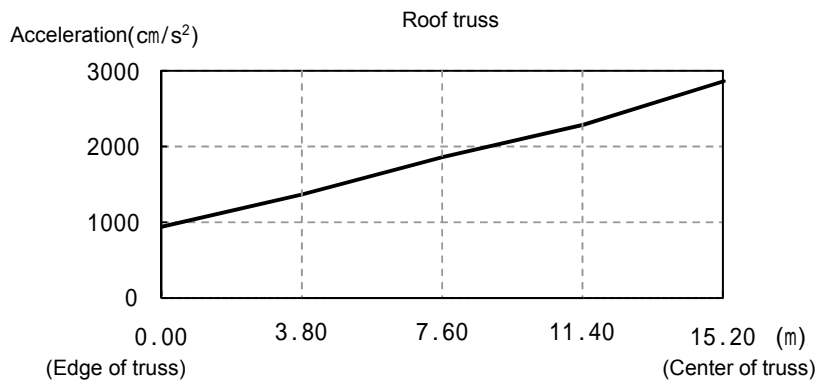

Figure 3.5.1(2): Maximum Response Acceleration (East-west)



Simulation analyses	925	1350	1860	2289	2862

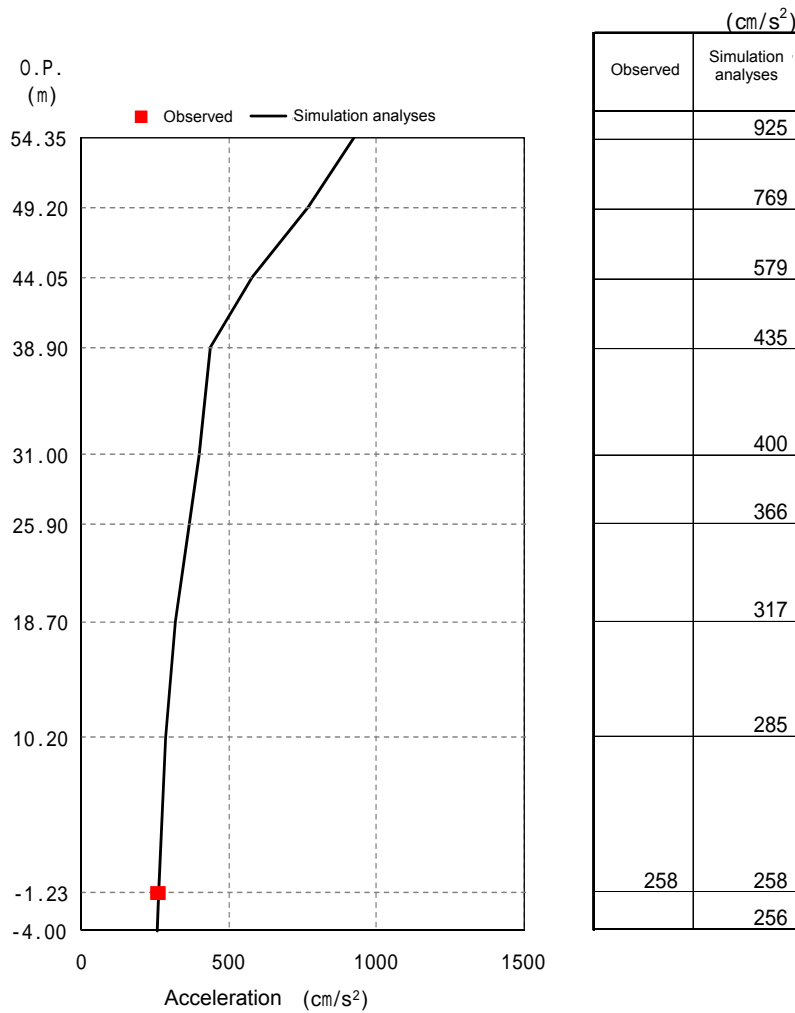

Figure 3.5.1(3): Maximum Response Acceleration (Vertical)

Table 3.5.1: Shear Strain of the Seismic Wall

( $\times 10^{-3}$ )

Floor	South-north	East-west
4F	0.05	0.05
3F	0.07	0.06
2F	0.12	0.11
1F	0.14	0.09
B1F	0.11	0.09



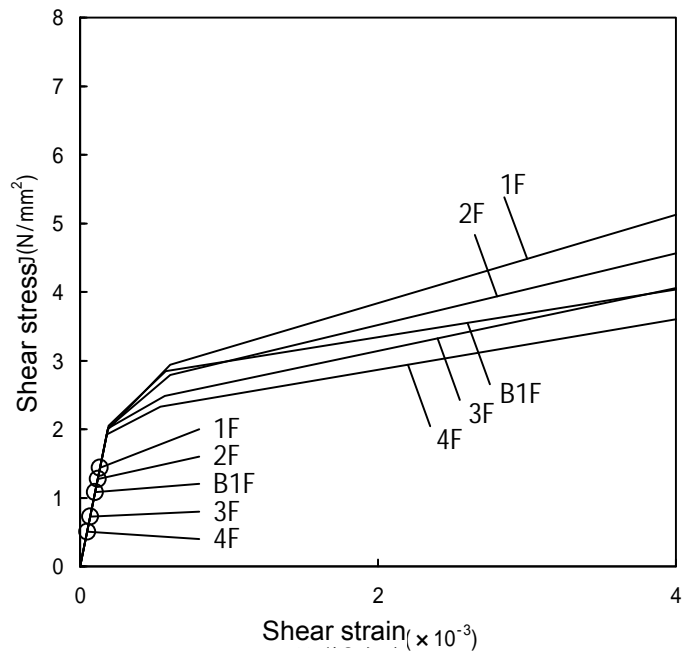

Figure 3.5.2(1): Maximum Response on the Shear Skeleton Curve  
(North-south Direction)

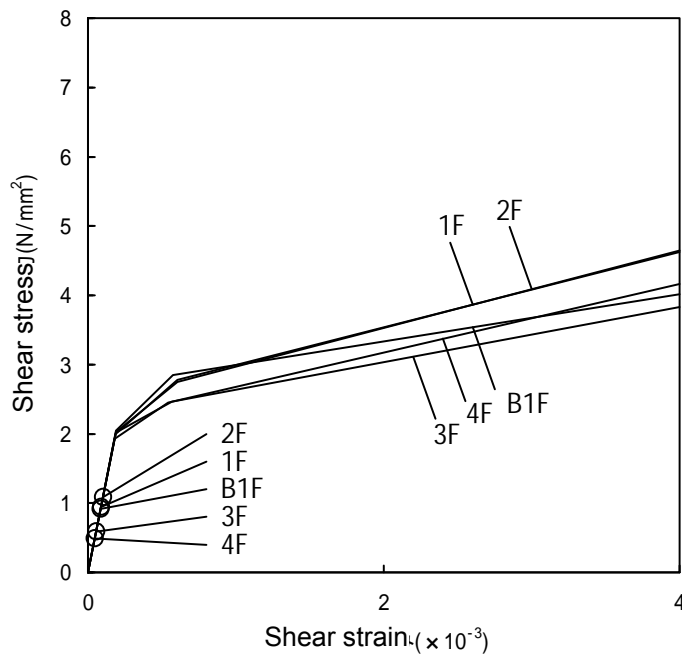

Figure 3.5.2(2): Maximum Response on the Shear Skeleton Curve  
(East-west Direction)

## **4. Assessment of Impact on the Important Equipment and Piping System for Seismic Safety**

### **4.1 Principle of Impact Assessment**

In this assessment, we will use analytical method to assess impact on the important equipment and piping systems on Seismic Safety due to Tohoku-Chihou-Taiheiyo-Oki Earthquake by using earthquake response analysis of reactor building based on the observation records of Tohoku-Chihou-Taiheiyo-Oki Earthquake.

Detailed method of impact assessment will be achieved by comparing response load and response acceleration (hereinafter “Earthquake Load”) which was obtained by earthquake response analysis of reactor building and earthquake response analysis of combination of reactor building and large equipment such as reactor (hereinafter “Earthquake Response Analysis of Combined Large Equipment”) and, Earthquake Load which was obtained by earthquake response analysis of Standard Earthquake Movement, Ss.

Seismic assessment of major facilities which has important safety function will be conducted, in the case Earthquake Load obtained by earthquake response analysis under this examination exceed Earthquake Load which was obtained by using Design Basis Ground Motion Ss.

## **4.2 Principle of Earthquake Response Analysis of Combined Large Equipment**

A model used for the earthquake response analysis of reactor building which combined with large equipment such as a reactor will be based on the model which was used for earthquake response analysis of reactor building in the previous chapter. A model for earthquake response analysis of large equipment such as a reactor will be same model as used for the previous earthquake response analysis for seismic safety assessment. However, in the case of the plant which was under the periodic maintenance at the occurrence of the earthquake, an earthquake response analysis model will be reviewed according to the situation at the time of the earthquake.

A damping constant applied for an earthquake response analysis model for large equipment will be same as that applied for the previous seismic safety assessment. Analysis will be conducted for horizontal (NS and EW) and vertical (UD) directions.

### 4.3 Method of Impact Assessment

For each unit of Fukushima Daiichi Nuclear Power Station, a seismic safety assessment by using Design Basis Ground Motion, Ss, was summarized as a preliminary report (hereinafter “Preliminary Report”)\*. In the report, it is concluded, as a result of the assessment, seismic safety will be secured for the major equipment which has important function regarding to “Shutdown” and “Cooling” of a reactor and “Containment” of radioactive materials against Design Basis Ground Motion Ss.

In light of above conclusion, an impact assessment will be conducted referring to the previous Earthquake Load calculated by using Design Basis Ground Motion Ss in this assessment.

For the first step, comparison of the Earthquake Load obtained an earthquake response analysis based on observation records with that obtained in a previous seismic safety assessment will be conducted.

In the case that the Earthquake Load exceeds that obtained in the previous seismic safety assessment, a seismic assessment will be conducted, as the second step, for the selected facility related to the index of which exceeds the Earthquake Load obtained from a seismic safety assessment, from each Earthquake Load conditions obtained from Earthquake Response Analysis for Combined Large Equipment, out of major facilities which have important safety function.

A flowchart of impact assessment will be shown in the Figure 4.3.1.

\* Fukushima Daiichi Nuclear Power Station, Preliminary Report (revision 2), Seismic Safety Assessment Result due to the revision of “Guideline on Evaluation of Seismic Design of Nuclear Reactor Facility for Power Generation”, April 19, 2010 Tokyo Electric Power Company

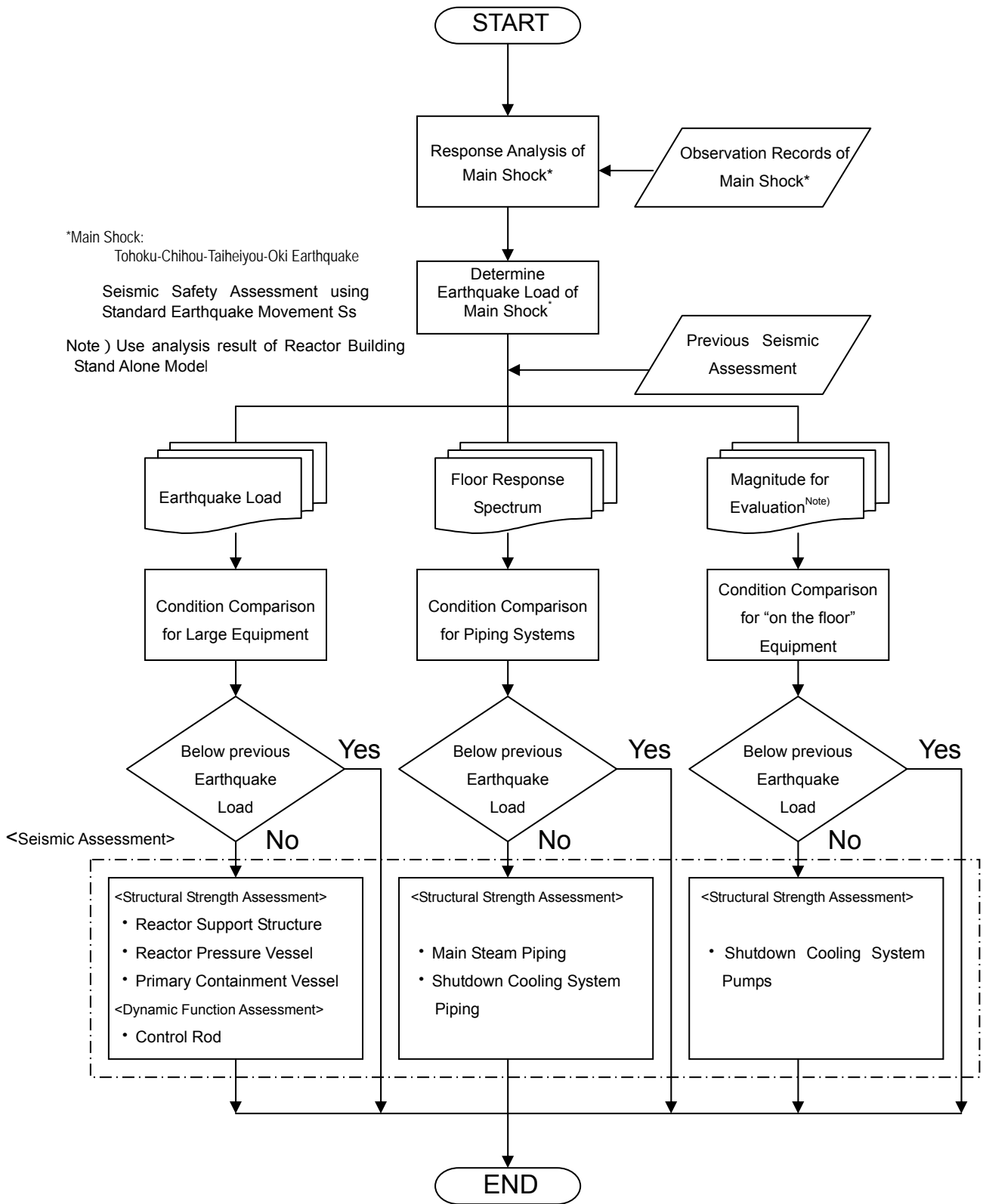

Figure-4.3.1 Flowchart of Main Shock Impact Assessment

### 4.3.1 Comparison with Previous Reviews

We have defined indices to compare with previous reviews as shown in the following figure.

Figure-4.3.1.1 Indices for Seismic Response to Compare with Previous Reviews

Facility etc.	Load on seismic response	Calculation Model	Notes	
Reactor Building	Earthquake intensity and floor response spectrum (G)	Analysis Results of buildings <sup>*)</sup> in the previous chapter are used.	To be earthquake resistant design conditions of equipment and piping (for example, Shutdown Cooling System pumps and piping) installed on the floor of a reactor building	
R/B PCV	RPV and RPV Pedestal	Shear Force (kN)	To be seismic load conditions of a RPV	
		Moment (kN·m)		
	Axial Force (kN)	Vertical Direction Model		
RPV Coupled System	Reactor Shield Wall	Floor Response Spectrum (G)	Horizontal and Vertical Direction Model	To be seismic load conditions of reactor coolant pressure boundary piping such as main steam piping system
	PCV	Shear Force (kN)	Horizontal Direction Model	To be seismic load conditions of a main unit of a PCV
		Moment (kN·m)		
Axial Force (kN)	Vertical Direction Model			
R/B Core Internals coupled system	Fuel Assembly	Relative Displacement (mm)	Horizontal Direction Model	To be mainly conditions to evaluate the maintenance of dynamic functions of control rods
	Separator and Core Shroud	Shear Force (kN)	Horizontal Direction Model	To be seismic load conditions of core support structure
		Moment (kN·m)		
Axial Force (kN)	Vertical Direction Model			

\*) According to simulation analyses based on observation records, floor response spectrum in a vertical direction is considered to achieve a peak in analyses (Please refer to Supplementary Document).

### **4.3.2 Seismic Assessment of Important Main Facility in the Light of Seismic Safety**

In the case that this seismic load etc. exceeds those obtained in previous seismic safety evaluations, based on each exceeding index, we have picked up equipment corresponding to the index out of important main facility in the light of safety to be chosen to be evaluated in the interim report and conducted earthquake-proof evaluations. Main facilities in the Preliminary Report (Figure-4.3.2.1) cover indices compared in the previous section.

In structural intensity evaluation, we will conduct concise and detailed evaluation as shown below, figure out calculated values in this earthquake and then compare them with standard evaluation values. We will basically use the same conditions other than seismic load (pressures and temperatures etc.) as those in the seismic safety evaluation. However, we may review them, as we take conditions at the occurrence of the earthquake into consideration.

Regarding the evaluation of the maintenance of dynamic functions (the insertability of control rods), we will confirm the relative displacement of fuel assemblies at the earthquake was lower than that whose insertability of control rods is assured in a test.

#### **A. Concise Evaluation**

The ratio between seismic load such as acceleration, shear force, moment and axial force etc. at this earthquake and those at the time of design will be calculated, and they will be multiplied by a calculated value (stress). Then, the calculated value at this earthquake will be figured out.

#### **B. Detailed Evaluation**

This is the same evaluation method as in an intensity calculation

sheet at the time of design. Regarding a piping system, the evaluation will be basically based on a spectrum modal analysis, but a time historical response analysis will be conducted if necessary.

Figure-4.3.2.1 Equipments to be Evaluated

Classification	Equipments to be evaluated	Evaluated Parts	Notes
Shutdown	Core Support Structure	Shroud Support	Located in a lower part of a reactor core; A shroud support is selected as an evaluated part, because its seismic load is high.
	Control Rod	Insertability	Based on relative displacement of fuel assemblies at the earthquake, we will evaluate the insertability of fuel rods.
Cooling	Shutdown Cooling System Pump	Bolt	Bolts in a pump to be susceptible to an earthquake are selected as an evaluated part.
	Shutdown Cooling System Piping	Piping	A main unit of pipes with an emergency core cooling function will be evaluated.
Containment	Reactor Pressure Vessel	Foundation Bolt	A reactor pressure vessel has a thick structure and, as the presence or absence of a seismic load has little impact on its structure, foundation bolts in the anchorage zone are selected as an evaluated part.
	Main Steam Piping System	Piping	A main unit of reactor coolant pressure boundary piping will be evaluated.
	Primary Containment Vessel	Dry Well	A shell plate in a main unit will be selected as an evaluated part to maintain its boundary function..

## 4.4 Result of Impact Assessment

### 4.4.1 Seismic Intensity for Evaluation

Figure-4.4.1.1 shows the comparison of a seismic intensity for evaluation (1.2 times as large as floor maximum acceleration) based on a result of a seismic response analysis of a reactor building shown in the previous chapter with that of a reactor building by Design Basis Ground Motion Ss.

The seismic safety evaluation was conducted on the cooling system pumps for reactor shutdown, since the seismic intensity for evaluation in the horizontal direction caused by this earthquake exceeded that in Design Basis Ground Motion Ss at O.P. 10.20 meter in the floor where the cooling system pumps for reactor shutdown are installed (Please refer to 4.4.4).



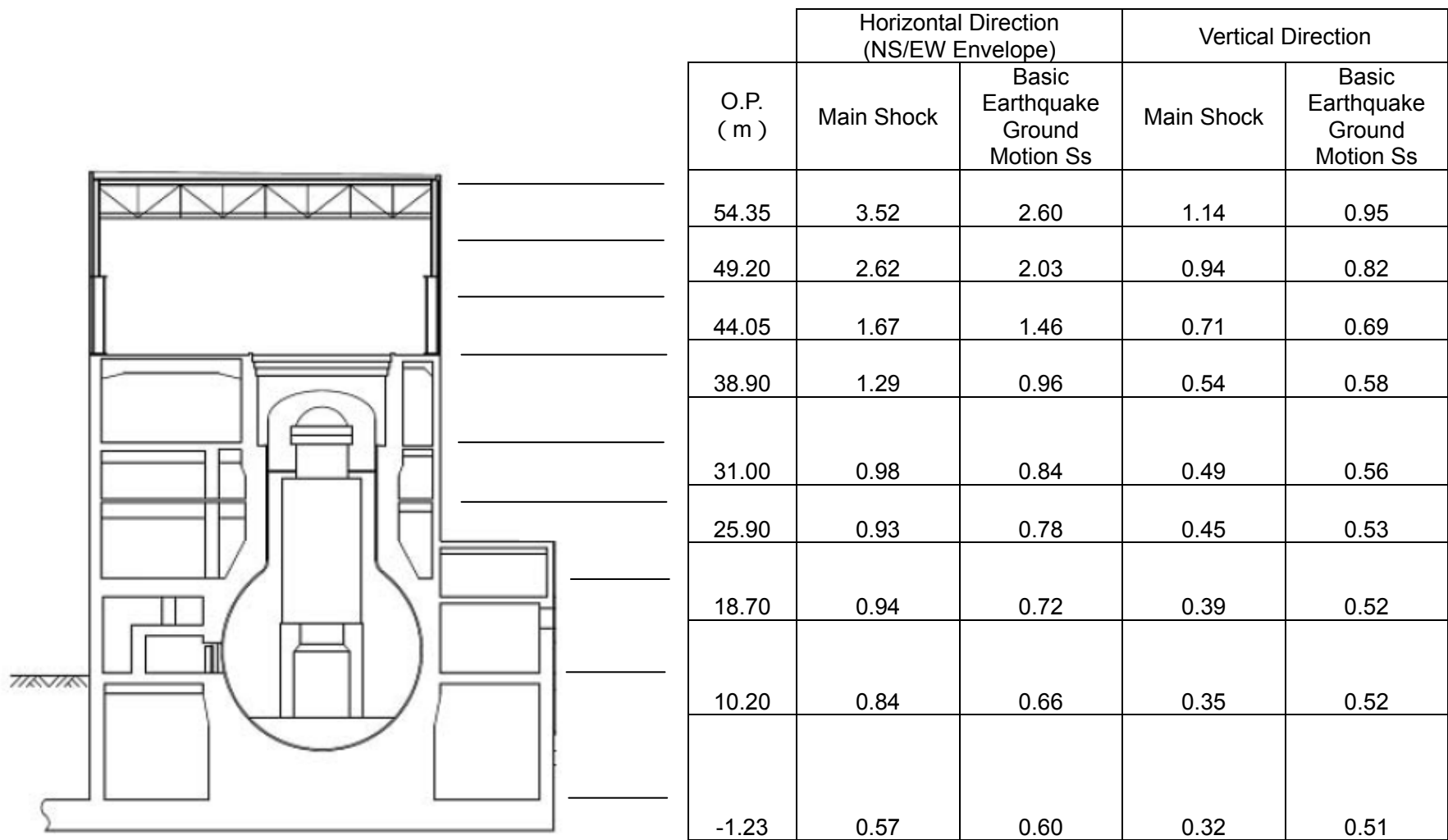
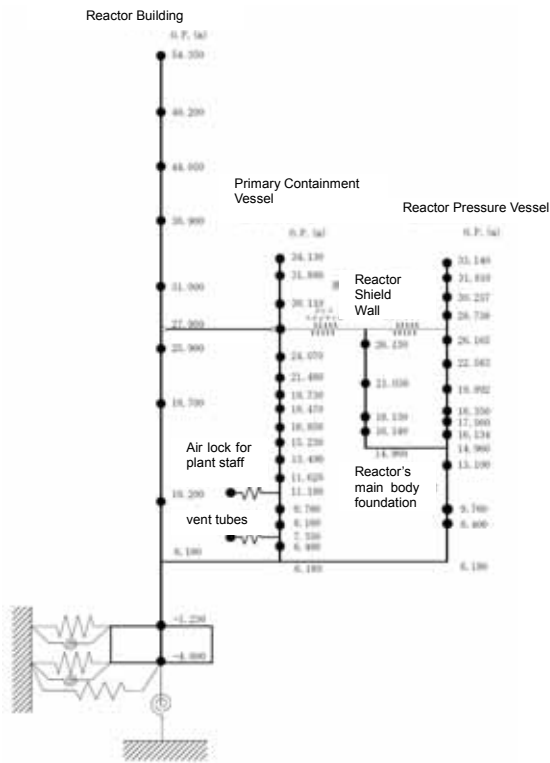

Figure-4.4.1.1 Seismic Intensity for Evaluation of Reactor Building

## **4.4.2 Results of Seismic Coupling Response Analysis of Large Equipment**

### **4.4.2.1 Analysis Model**

Seismic coupling response analysis model of large equipment of Unit 1, which had been operating at rated power output when the earthquake occurred, is formed by coupling of the reactor building model, which was analyzed in the previous chapter, and the analysis model of large equipment of reactors, which was used in the existing seismic safety assessment. An analysis model of large equipment is shown as Figure-4.4.2.1.1 and Figure-4.4.2.1.2.



(Horizontal Direction)

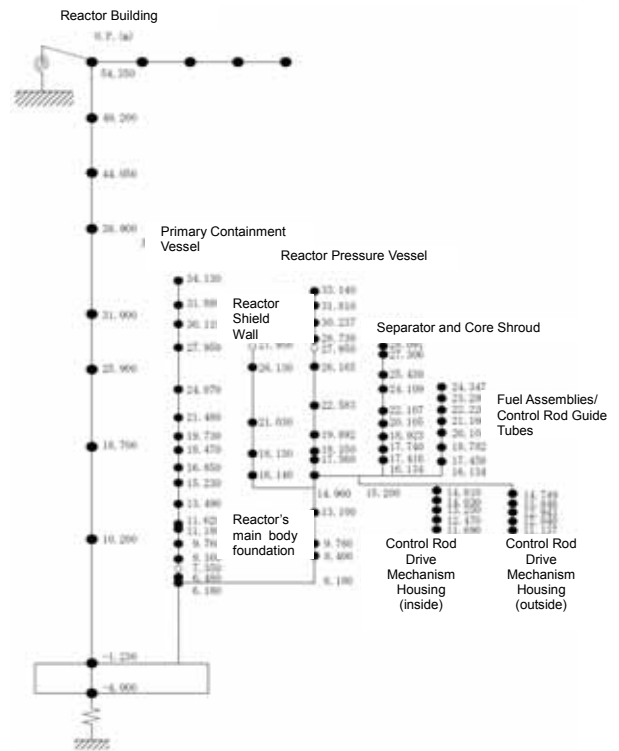

(Vertical Direction)

Figure-4.4.2.1.1 Coupling System Model of Reactor Building - Primary Containment Vessel - Reactor Pressure Vessel ( Fukushima Daiichi Unit 1 )

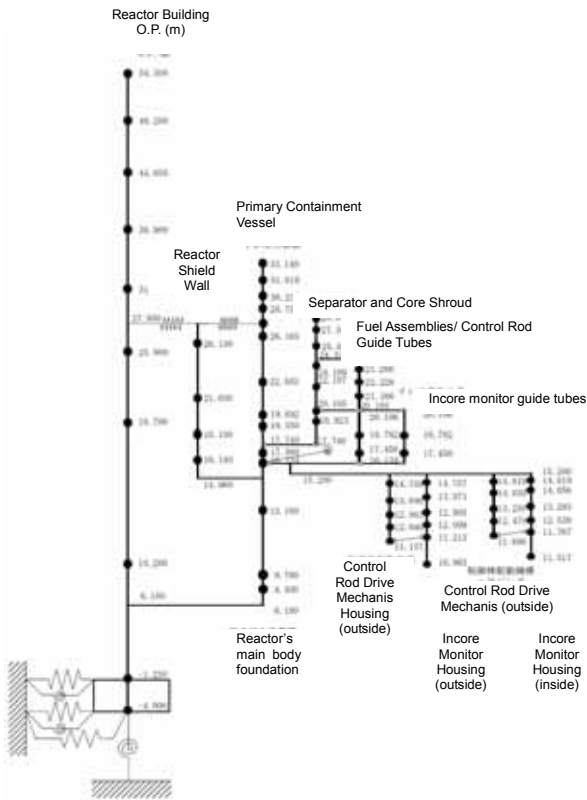

(Horizontal Direction)

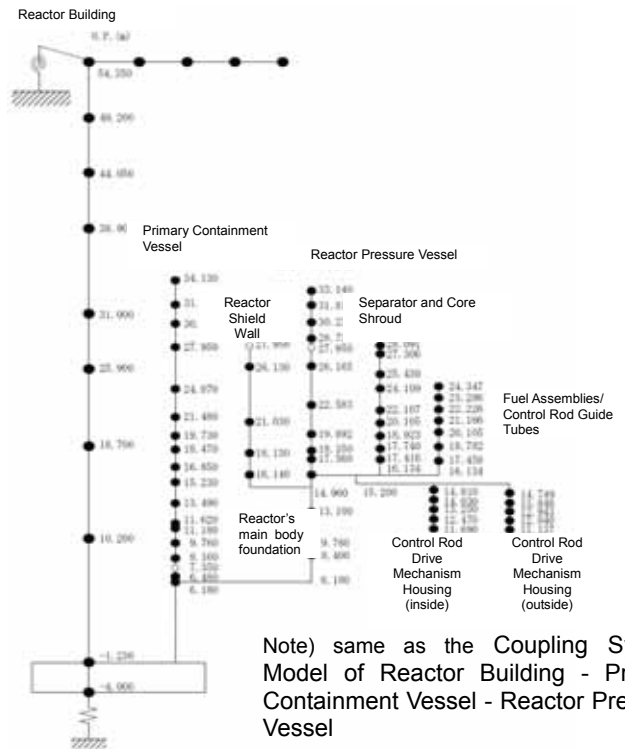

Note) same as the Coupling System Model of Reactor Building - Primary Containment Vessel - Reactor Pressure Vessel

(Vertical Direction)

Figure-4.4.2.1.2 Coupling System Model of Reactor Building - Reactor Internals ( Fukushima Daiichi Unit 1 )

#### **4.4.2.2 Results of Analysis**

The comparison between the seismic load based on the seismic response analysis of this time earthquake and the seismic load based on the seismic response analysis of the Design Basis Ground Motion Ss are shown in Figure-4.4.2.2.1 to Figure-4.4.2.2.6.

Since the seismic load of this earthquake exceeds the seismic load of Design Basis Ground Motion Ss with regards to the shear force and moment for the evaluation of Core Support Structure, Reactor Pressure Vessel and Primary Containment Vessel, seismic safety assessments of those facilities were conducted (refer 4.4.4).

Although the relative displacement of fuel assembly of this earthquake exceeds the relative displacement of Design Basis Ground Motion Ss, it is confirmed by the record of main control room that all rods are completely inserted at the time of the earthquake.

“Analysis and evaluation of the operation record and accident record of Fukushima Daiichi Nuclear Power Station at the time of Tohoku-Chihou-Taiheiyo-Oki-Earthquake” May 23, 2011 Tokyo Electric Power Company

Note ) Values in figure indicate maximum response value in Design Basis Ground Motion Ss and main quake of this time (Blue : Design Basis Ground Motion Ss , Red : Main quake of this time (PR))

4-12

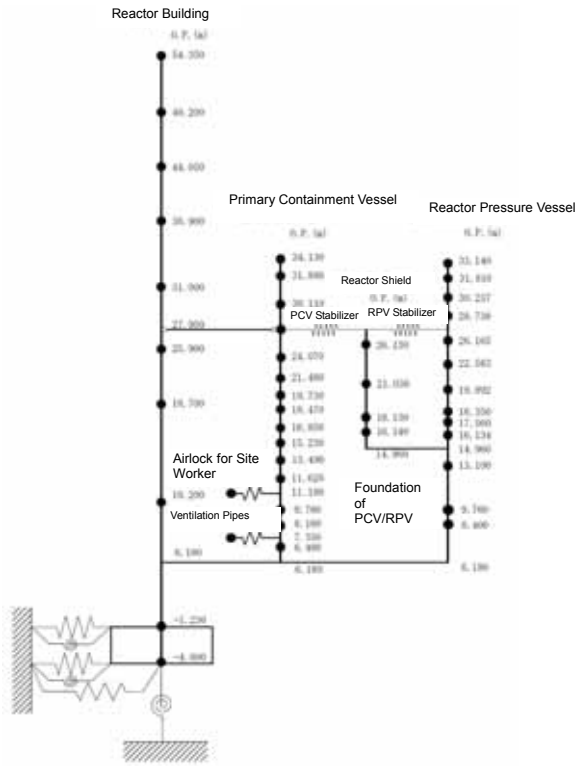
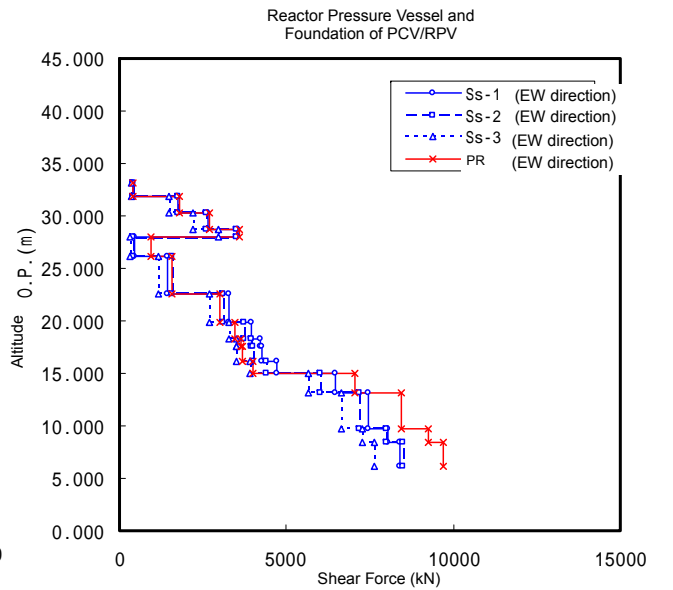
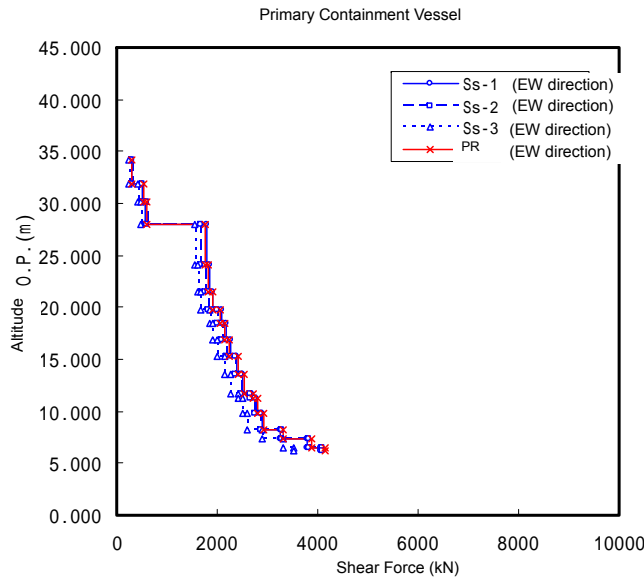
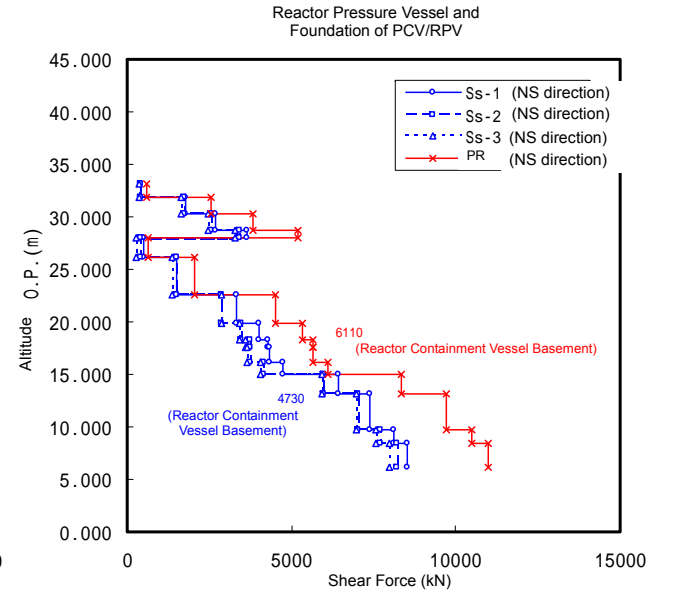
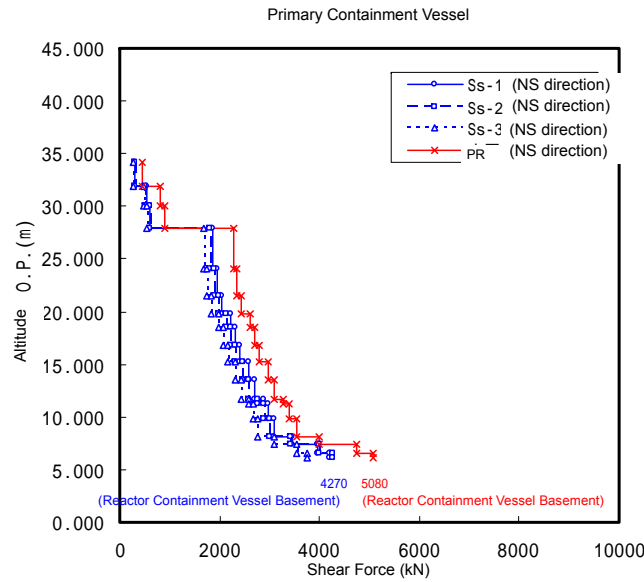

Figure-4.4.2.2.1 Maximum Response Shear Force  
( NS,EW Direction )  
( Primary Containment Vessel, Reactor Pressure Vessel and Foundation of PCV/RPV )



Note ) Values in figure indicate maximum response value in Design Basis Ground Motion Ss and main quake of this time (Blue : Design Basis Ground Motion Ss , Red : Main quake of this time (PR))

4-13

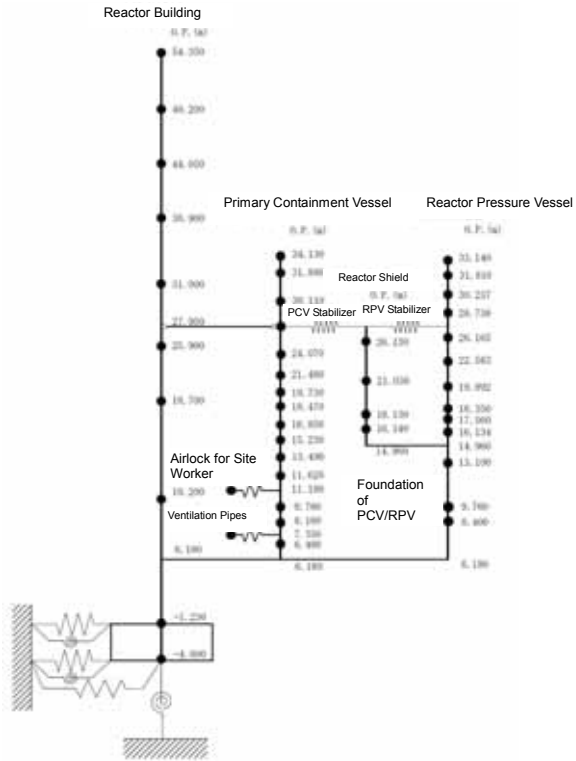
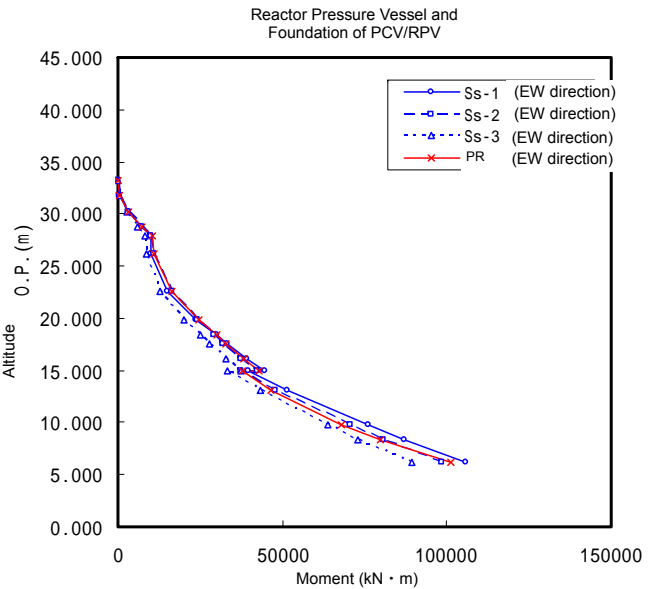
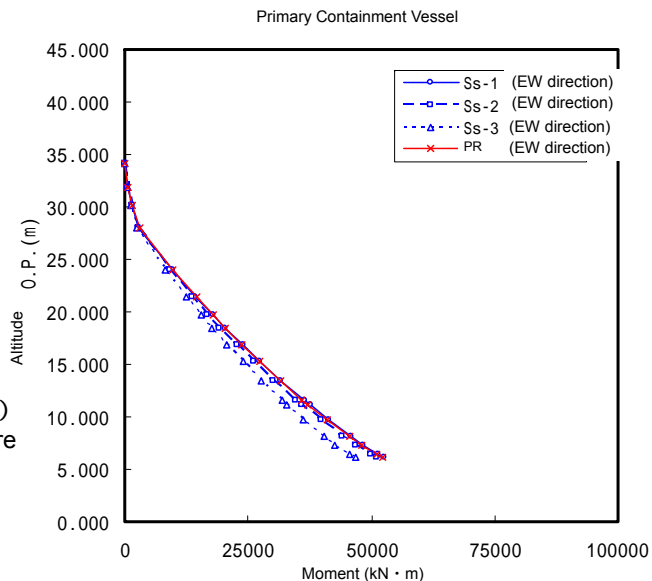
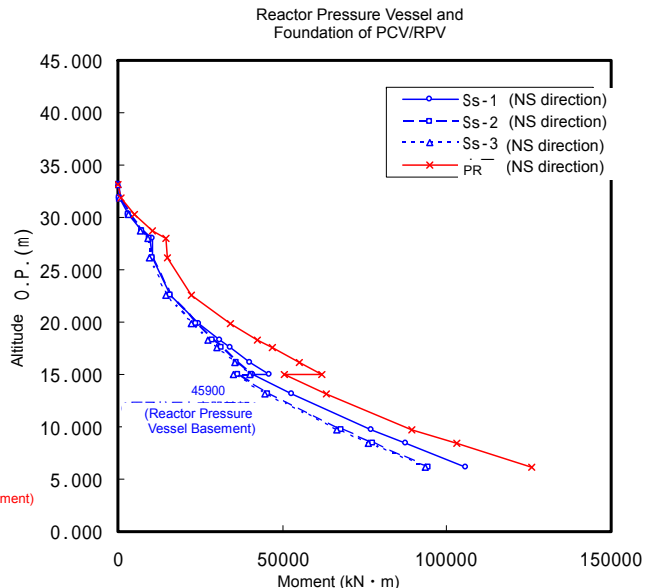
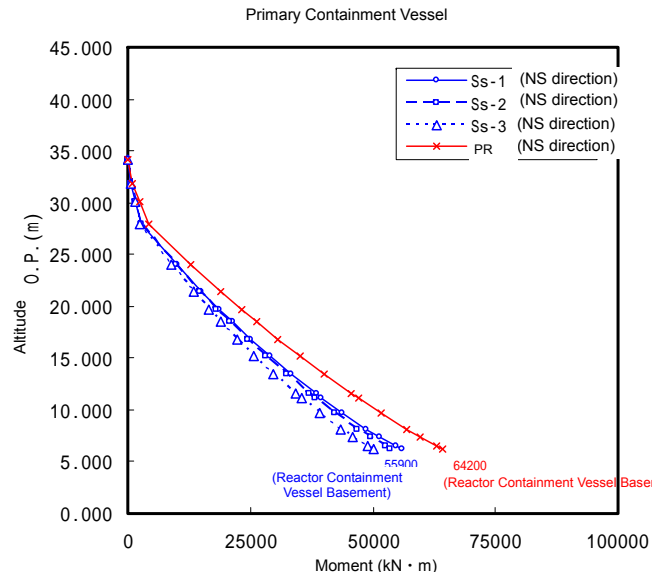

Figure-4.4.2.2.2 Maximum Response Moment (NS,EW Direction) ( Primary Containment Vessel, Reactor Pressure Vessel and Foundation of PCV/RPV )



Note ) Values in figure indicate maximum response value in Design Basis Ground Motion Ss and main quake of this time (Blue : Design Basis Ground Motion Ss , Red : Main quake of this time (PR))

4-14

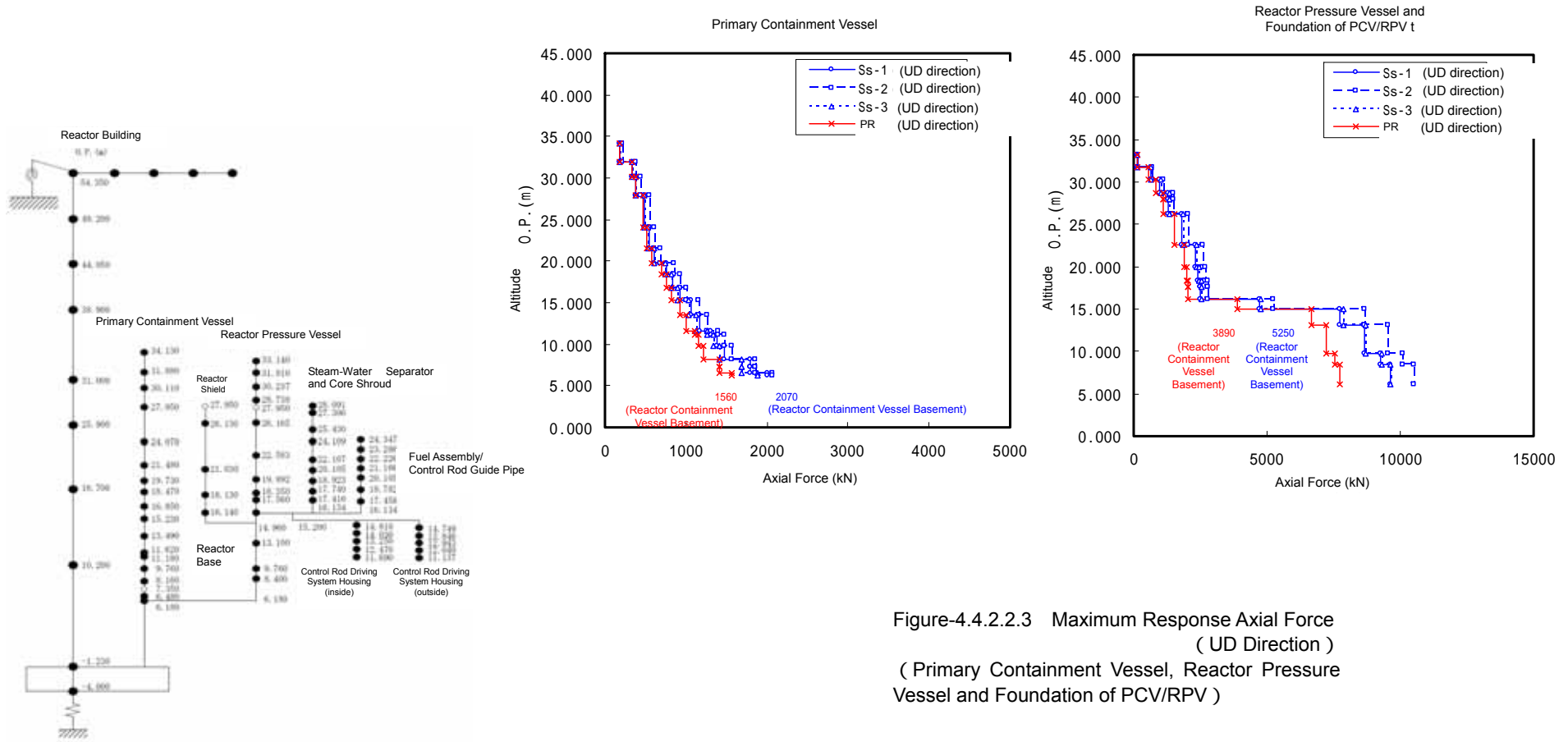

Figure-4.4.2.2.3 Maximum Response Axial Force (UD Direction) (Primary Containment Vessel, Reactor Pressure Vessel and Foundation of PCV/RPV)

Note ) Values in figure indicate maximum response value in Design Basis Ground Motion Ss and main quake of this time (Blue : Design Basis Ground Motion Ss , Red : Main quake of this time (PR))

4-15

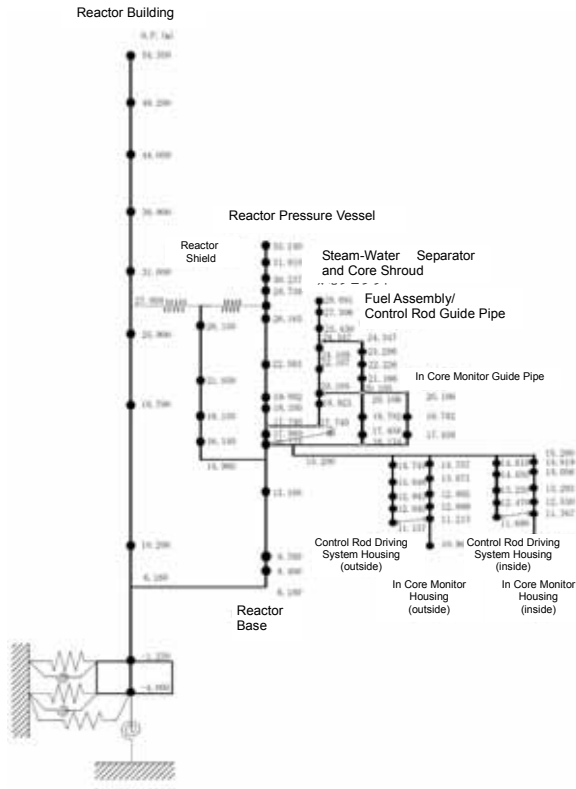
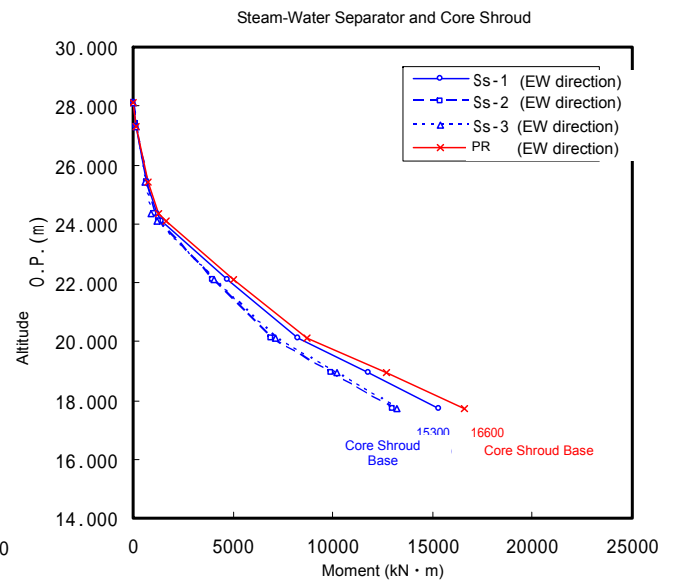
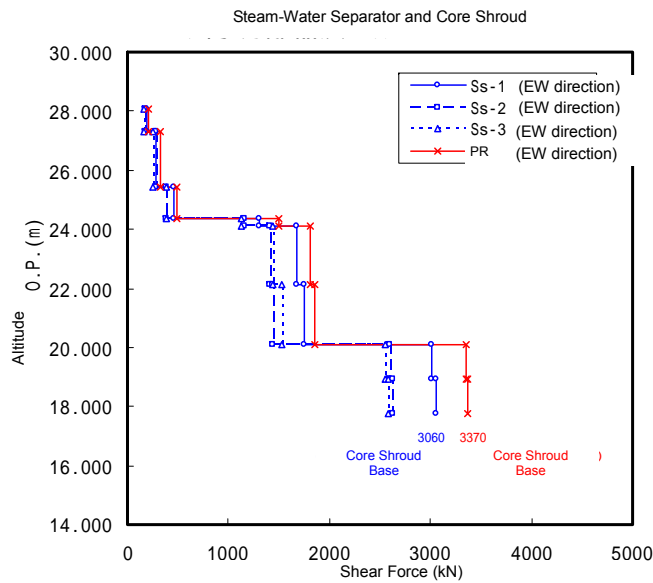
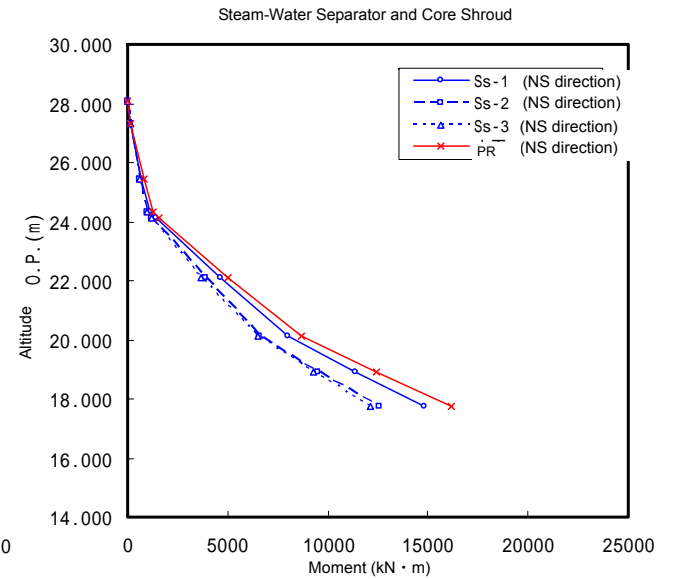
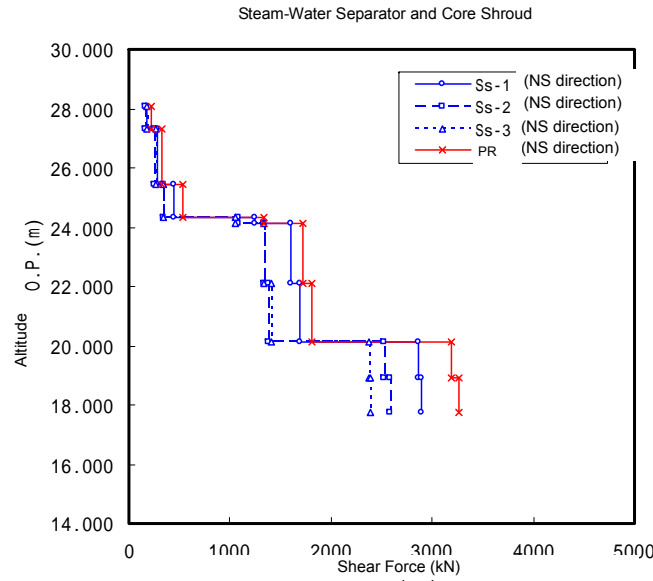

Figure-4.4.2.2.4 Maximum Response Shear Force, Maximum Response Moment ( NS,EW Direction )

( Steam-Water Separator and Core Shroud )





Note ) Values in figure indicate maximum response value in Design Basis Ground Motion Ss and main quake of this time (Blue : Design Basis Ground Motion Ss , Red : Main quake of this time (PR))

4-16

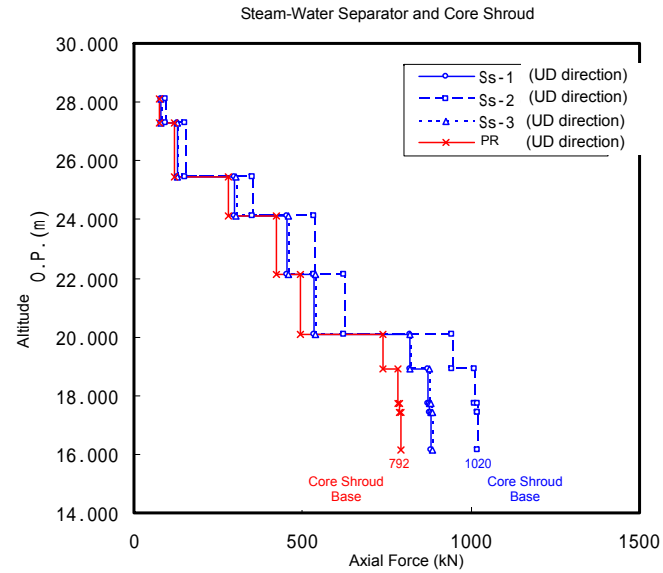
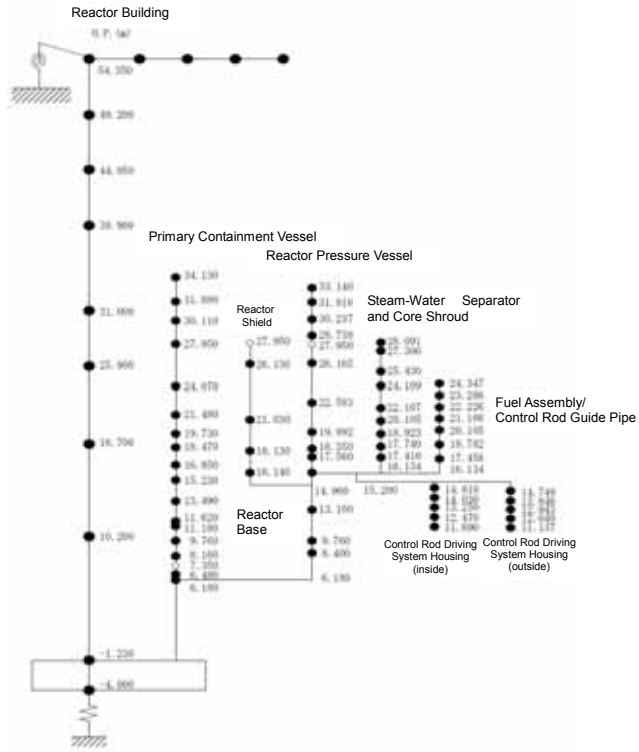

Figure-4.4.2.2.5 Maximum Response Axial Force ( UD direction ) ( Steam-Water Separator and Core Shroud )

Note ) Values in figure indicate maximum response value in Design Basis Ground Motion Ss and main quake of this time (Blue : Design Basis Ground Motion Ss , Red : Main quake of this time (PR))

4-17

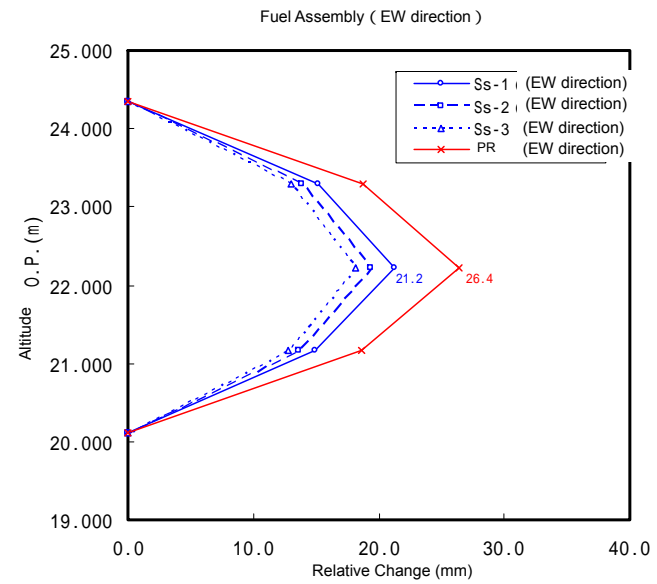
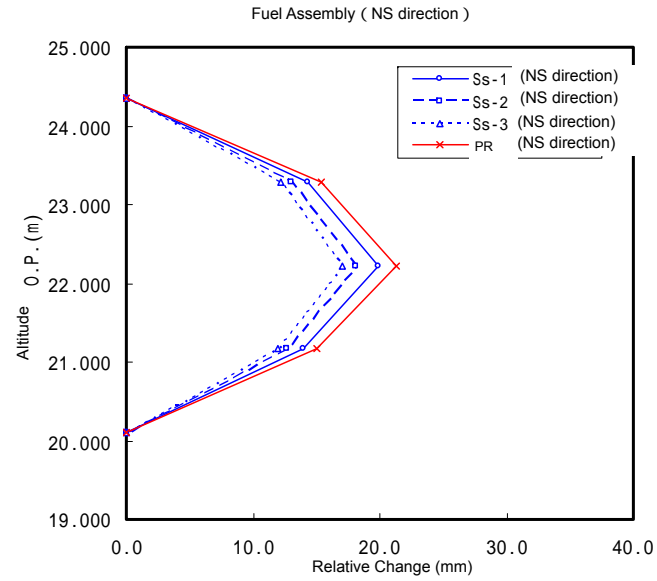
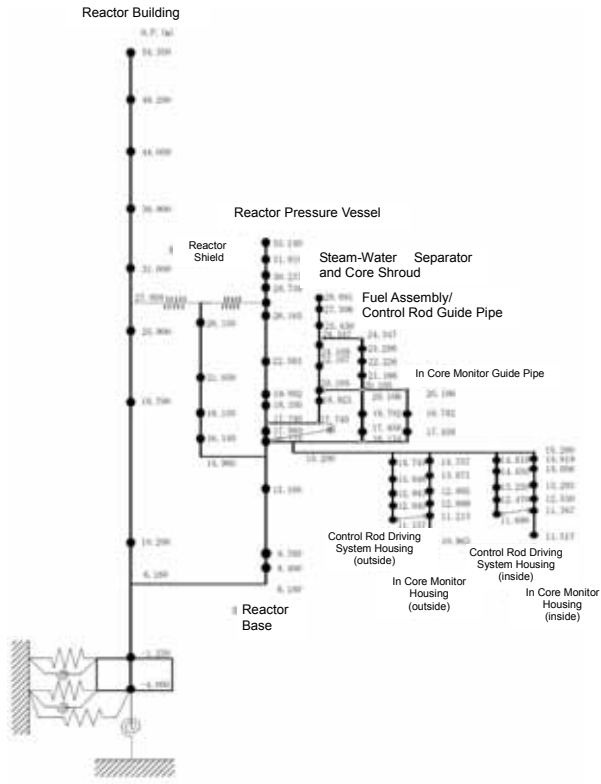

Figure-4.4.2.2.6 Relative Change of Fuel Assembly ( NS Direction and EW Direction )

### **4.4.3 Floor Response Spectrum**

Floor response spectrum based on the seismic response analysis of the reactor building described in the previous section and floor response spectrum based on the coupled seismic response analysis of large equipments are compared with floor response spectrum based on Design Basis Ground Motion, and these results are shown in Figure shown in Figure-4.4.3.1 ~ Figure-4.4.3.12.

As a result, earthquake intensity this time is mostly below Design Basis Ground Motion  $S_s$ , but in some periodic bands (approx. 0.2-0.3 seconds) it is above Design Basis Ground Motion  $S_s$ . Since natural period bands of main steam system piping arrangement and piping arrangement for cooling system in reactor stop are mostly less than approx. 0.27 seconds, we conducted the evaluation of seismic capacities of main steam system piping arrangement and piping arrangement for cooling system in reactor stop (Please refer to 4.4.4).

Note ) Not shaded, since neither main steam system piping arrangement nor piping arrangement for cooling system in reactor stop is installed in the reactor building O.P.38.90m.

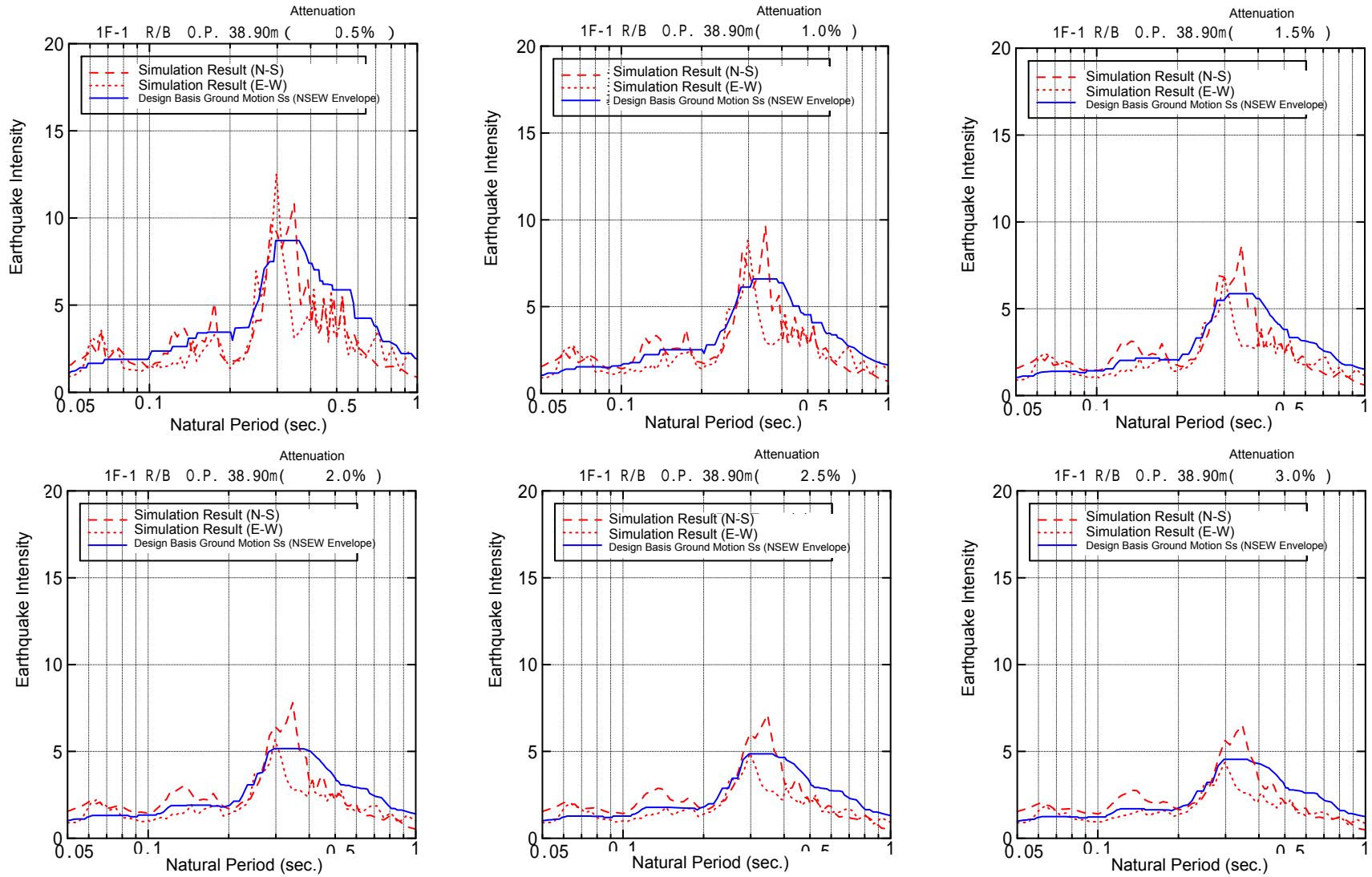
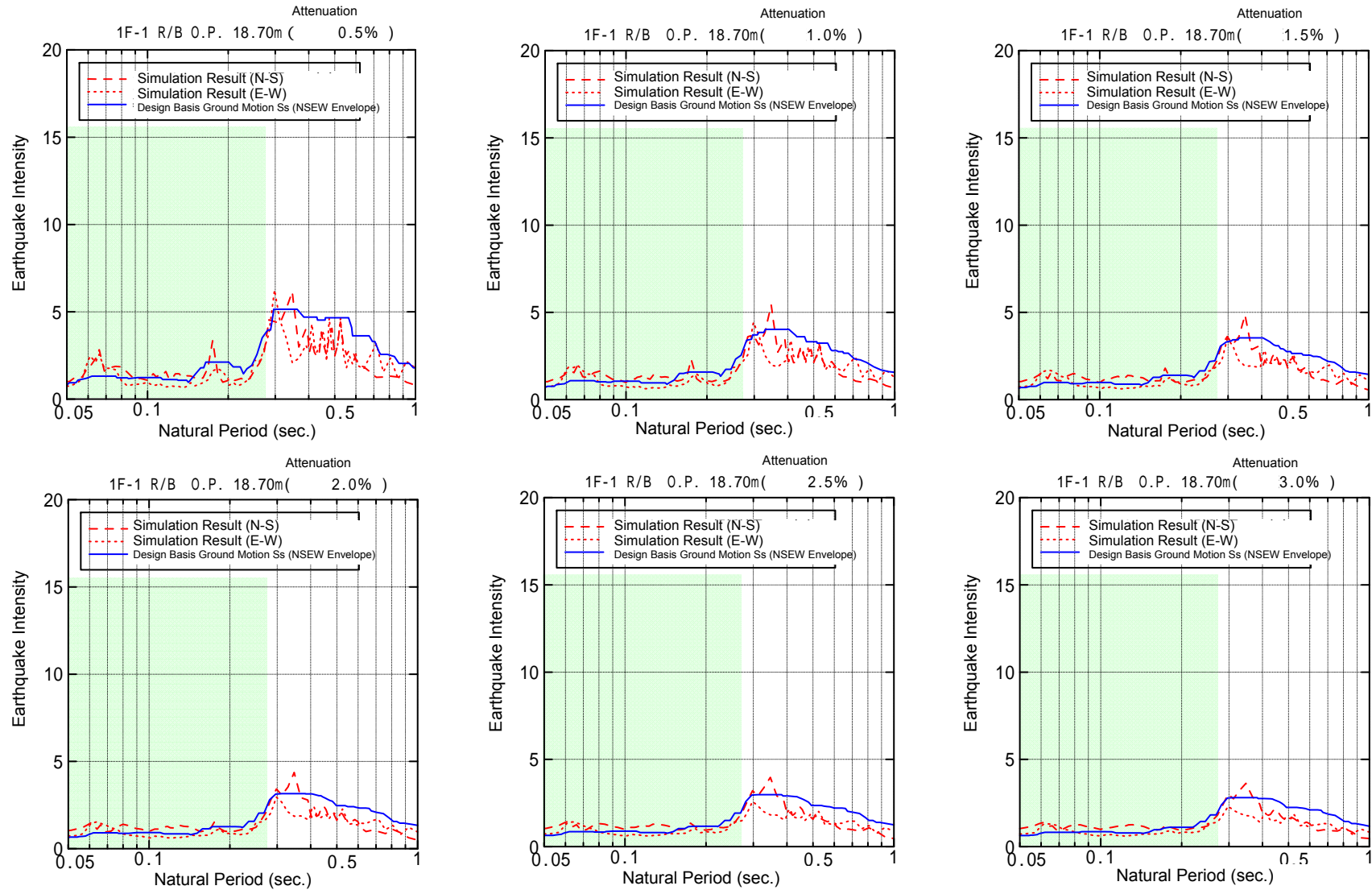

Figure-4.4.3.1 Reactor Building O.P. 38.90m Floor Response Spectrum ( Horizontal direction )

Note ) Shaded area represents where natural periods exist for main steam system piping arrangement and piping arrangement for cooling system in reactor stop.



4-20

Figure-4.4.3.2 Reactor Building O.P. 18.70m Floor Response Spectrum ( Horizontal direction )

Note ) Shaded area represents where natural periods exist for main steam system piping arrangement and piping arrangement for cooling system in reactor stop.

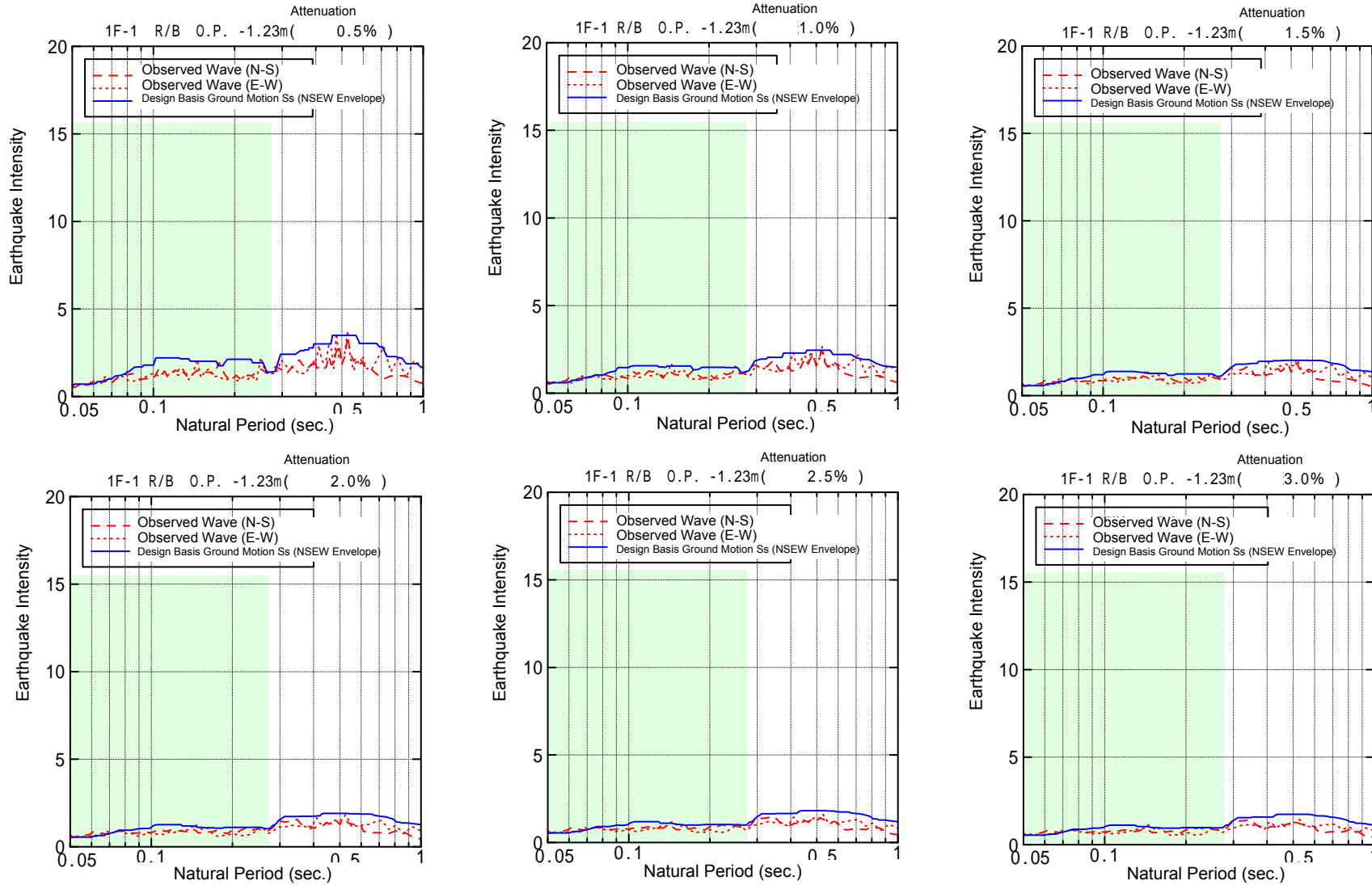

Figure-4.4.3.3 Reactor Building O.P. -1.23m Floor Response Spectrum ( Horizontal direction )

Note ) Not shaded, since neither main steam system piping arrangement nor residual heat removal system piping arrangement is installed in the reactor building O.P.38.90m.

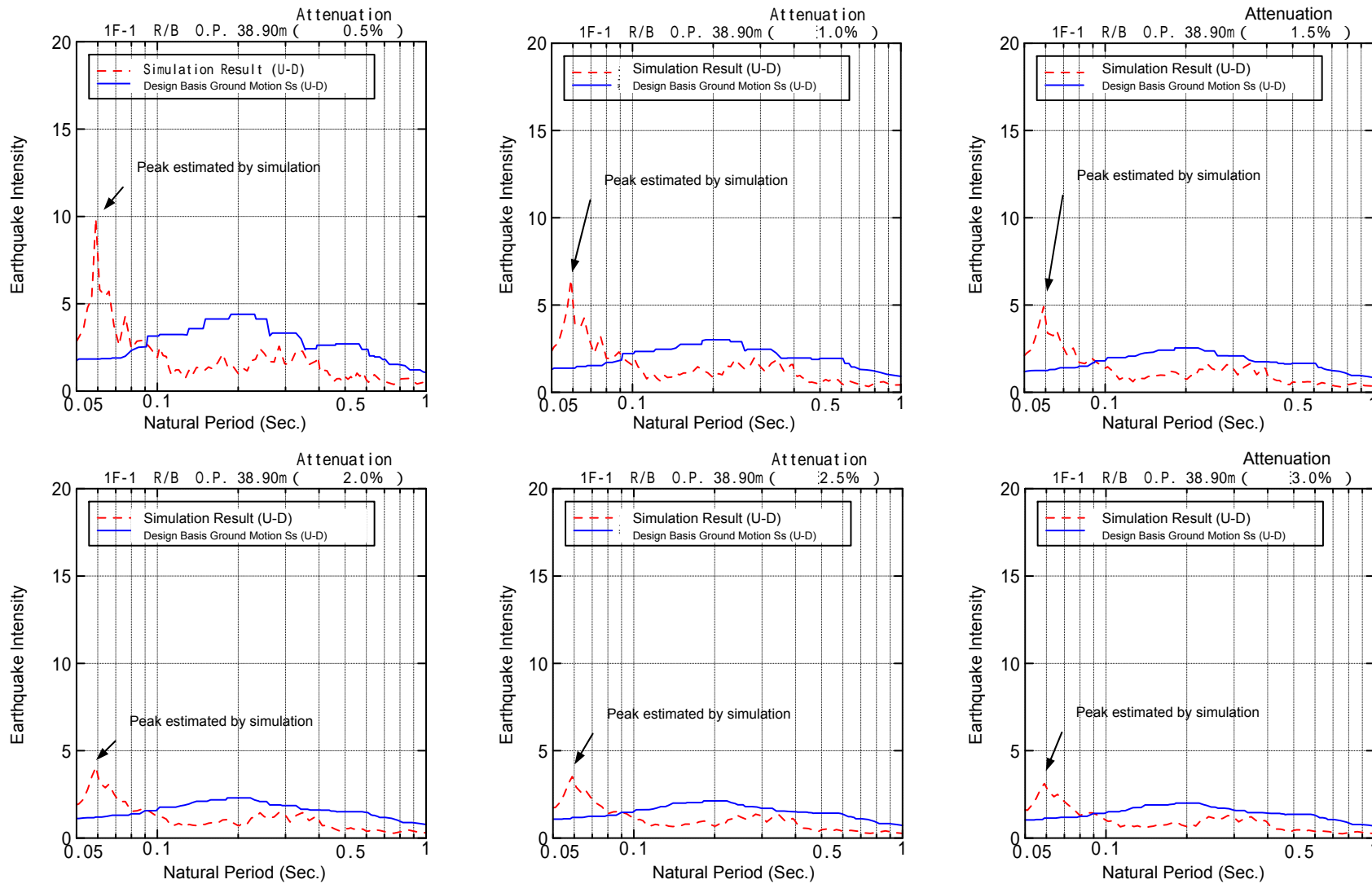

Figure-4.4.3.4 Reactor Building O.P. 38.90m Floor Response Spectrum ( Vertical direction )

Note ) Shaded area represents where natural periods exist for main steam system piping arrangement and residual heat removal system piping arrangement.

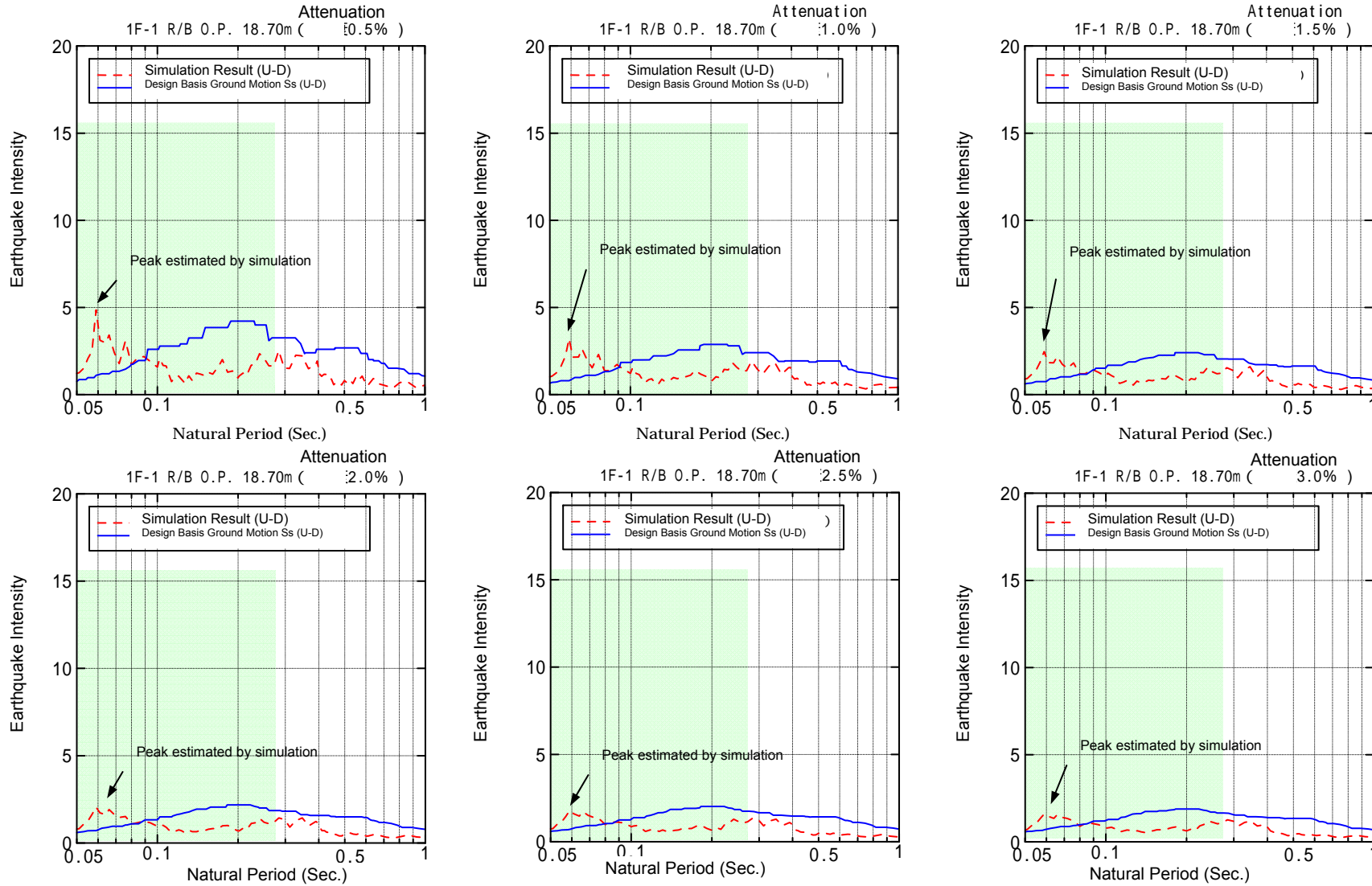

Figure-4.4.3.5 Reactor Building O.P. 18.70m Floor Response Spectrum ( Vertical direction )



Note ) Shaded area represents where natural periods exist for main steam system piping arrangement and residual heat removal system piping arrangement.

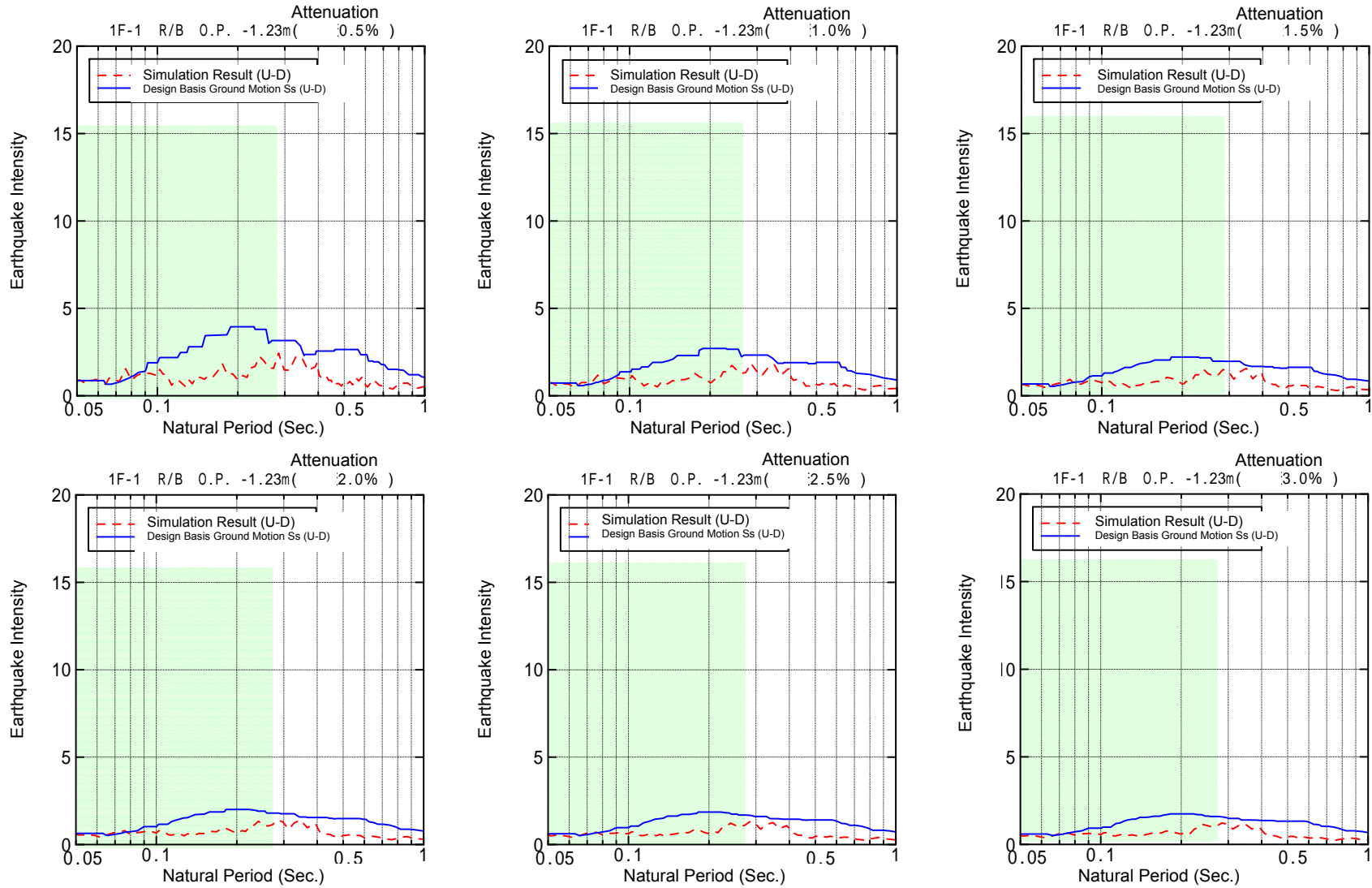

Figure-4.4.3.6 Reactor Building O.P. -1.23m Floor Response Spectrum ( Vertical direction )

Note ) Shaded area represents where natural periods exist for main steam system piping arrangement and residual heat removal system piping arrangement.

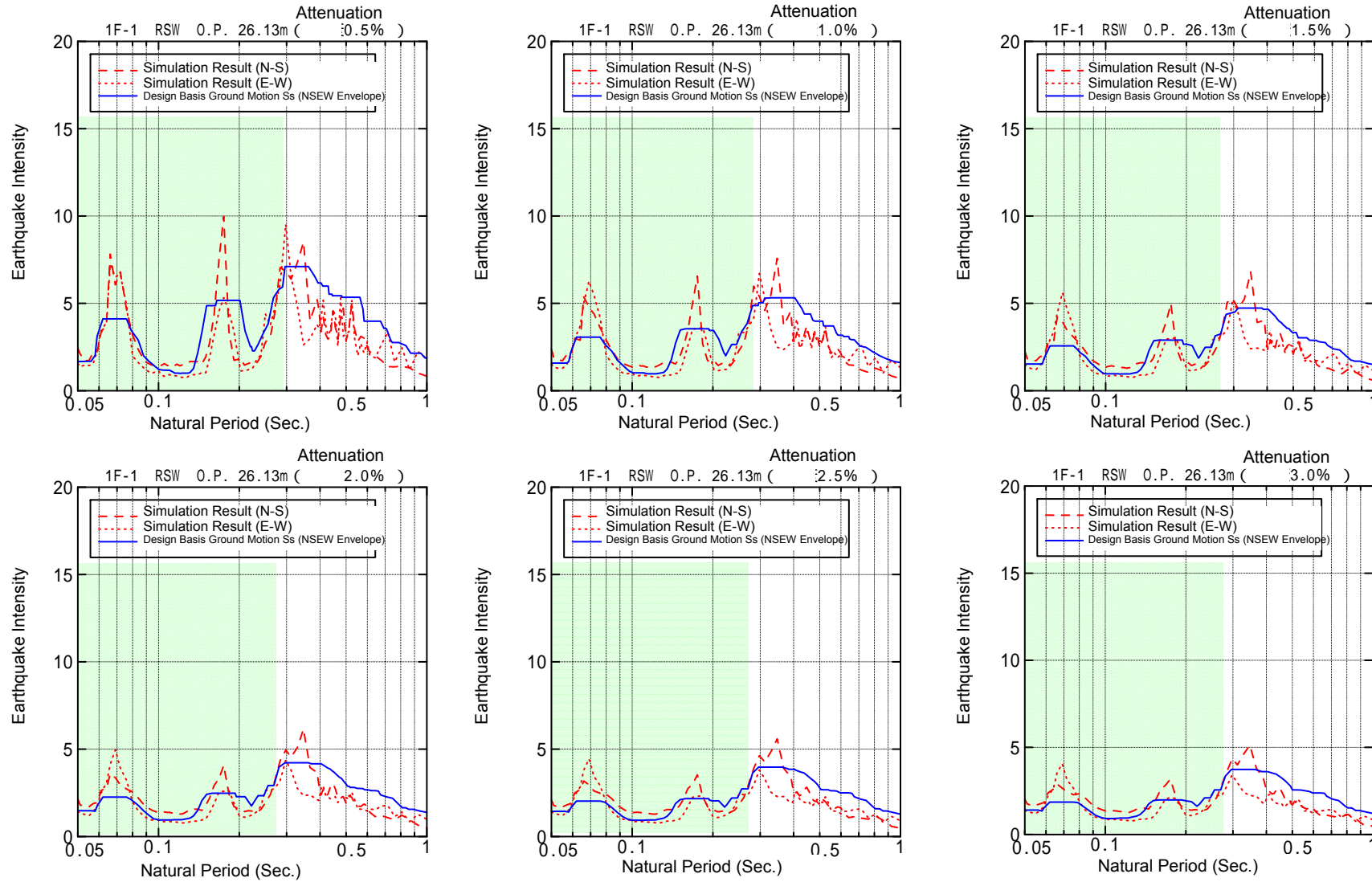

Figure-4.4.3.7 Reactor Shield Wall O.P. 26.13m Floor Response Spectrum ( Horizontal direction )

Note ) Shaded area represents where natural periods exist for main steam system piping arrangement and residual heat removal system piping arrangement.

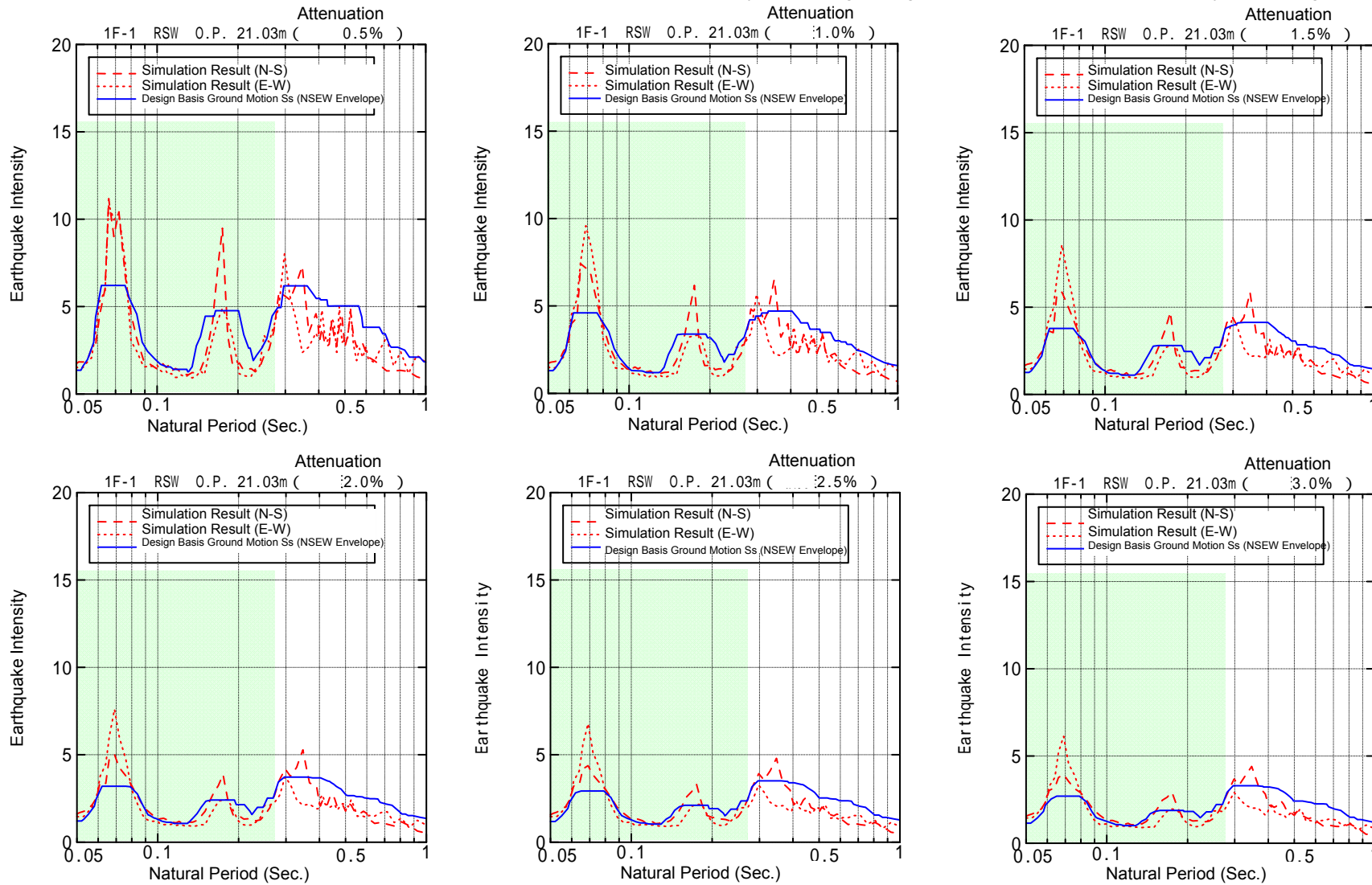

Figure-4.4.3.8 Reactor Shield Wall O.P. 21.03m Floor Response Spectrum ( Horizontal direction )

Note ) Shaded area represents where natural periods exist for main steam system piping arrangement and residual heat removal system piping arrangement.

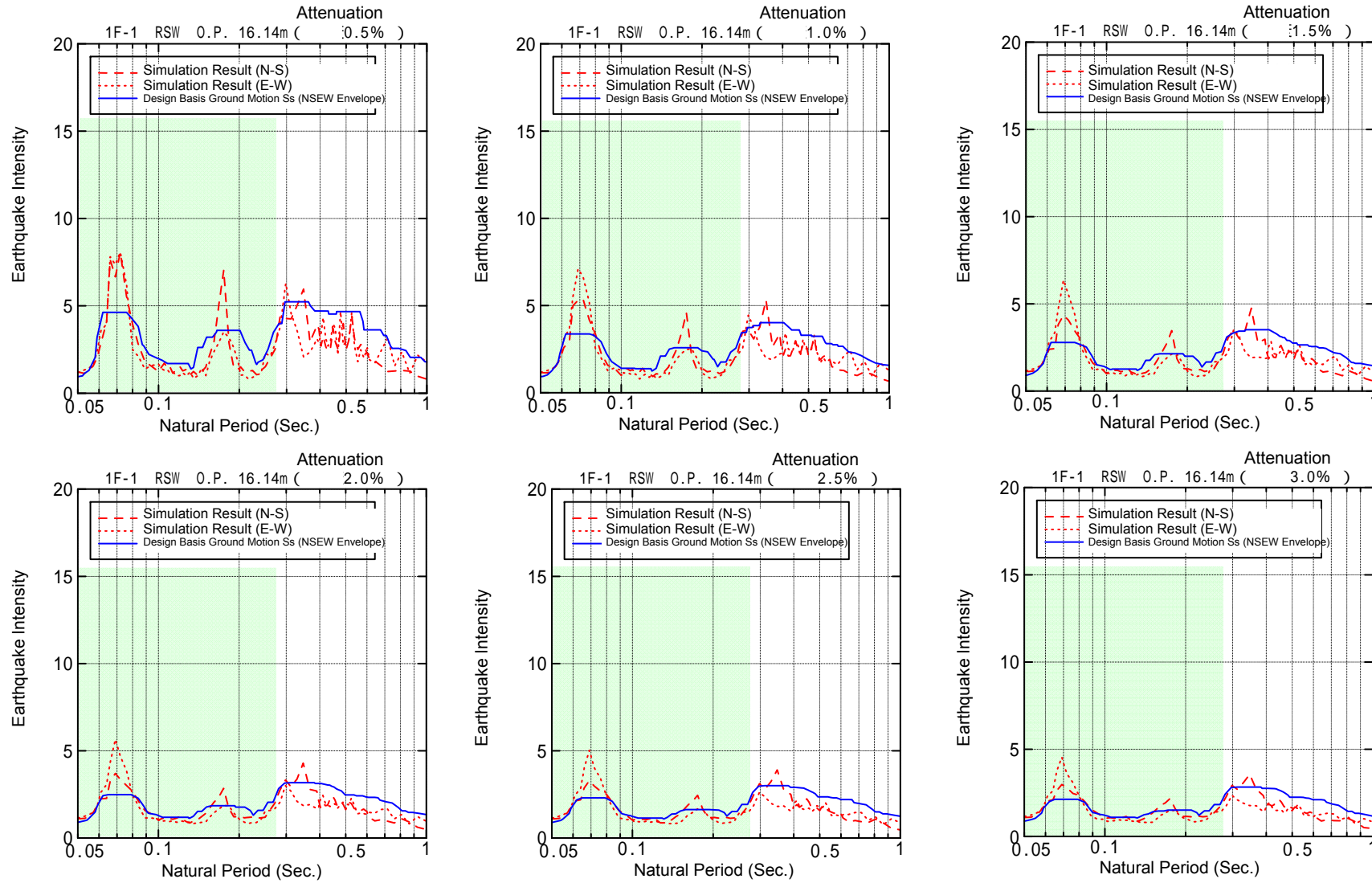

Figure-4.4.3.9 Reactor Shield Wall O.P. 16.14m Floor Response Spectrum ( Horizontal direction )

Note ) Shaded area represents where natural periods exist for main steam system piping arrangement and residual heat removal system piping arrangement.

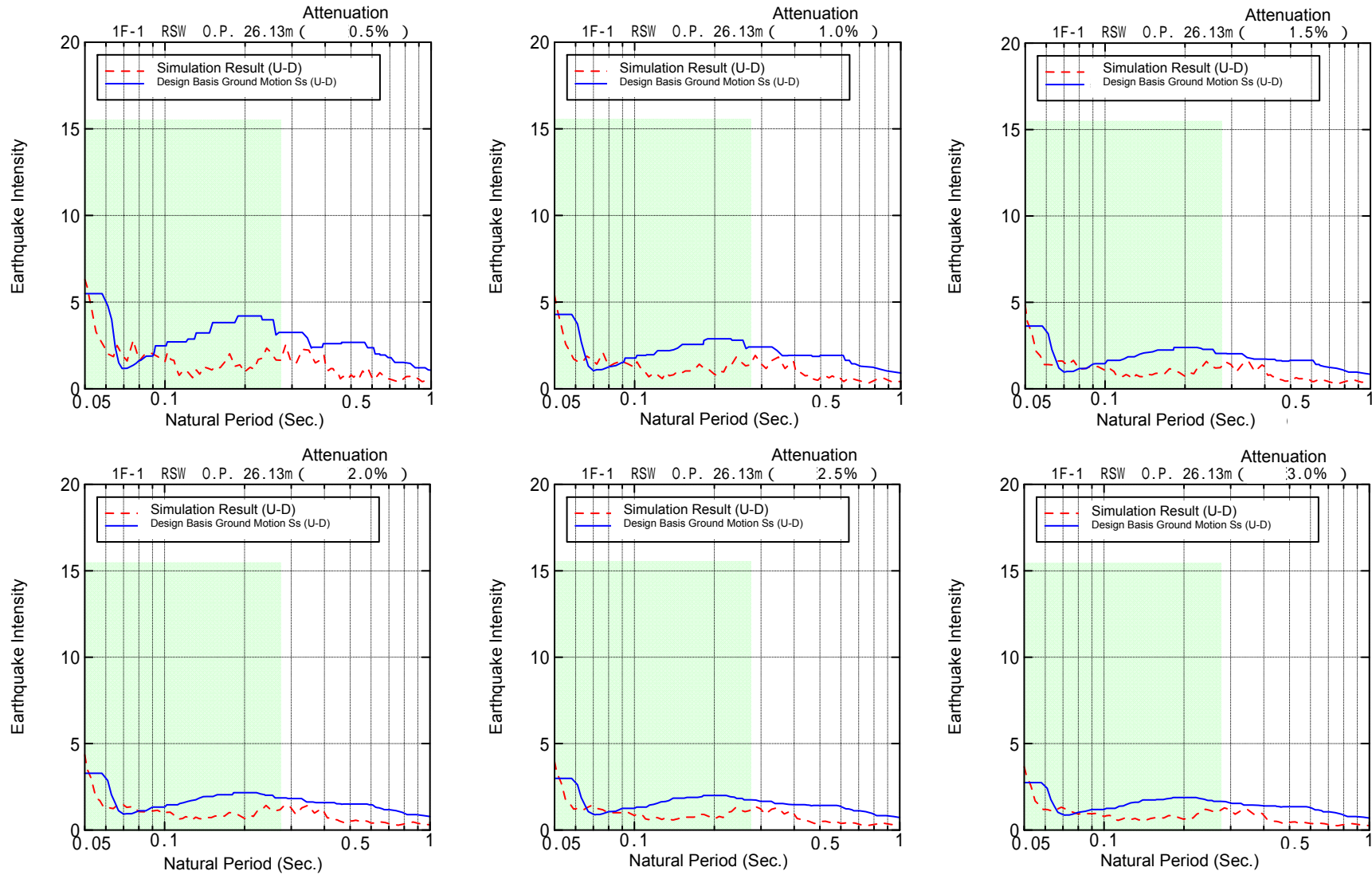

Figure-4.4.3.10 Reactor Shield Wall O.P. 26.13m Floor Response Spectrum ( Vertical direction )

Note ) Shaded area represents where natural periods exist for main steam system piping arrangement and residual heat removal system piping arrangement.

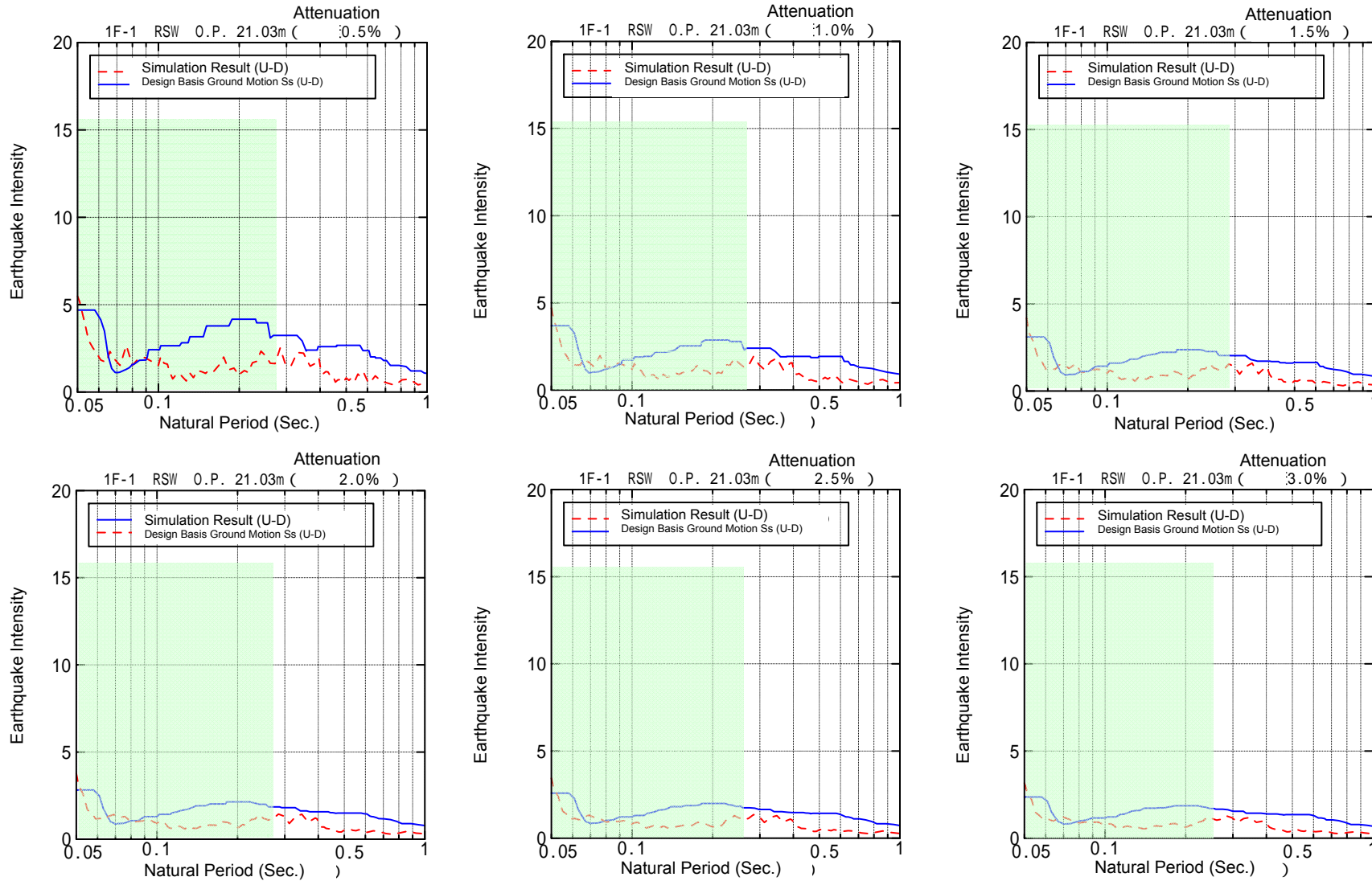

Figure-4.4.3.11 Reactor Shield Wall O.P. 21.03m Floor Response Spectrum ( Vertical direction )

Note ) Shaded area represents where natural periods exist for main steam system piping arrangement and residual heat removal system piping arrangement.

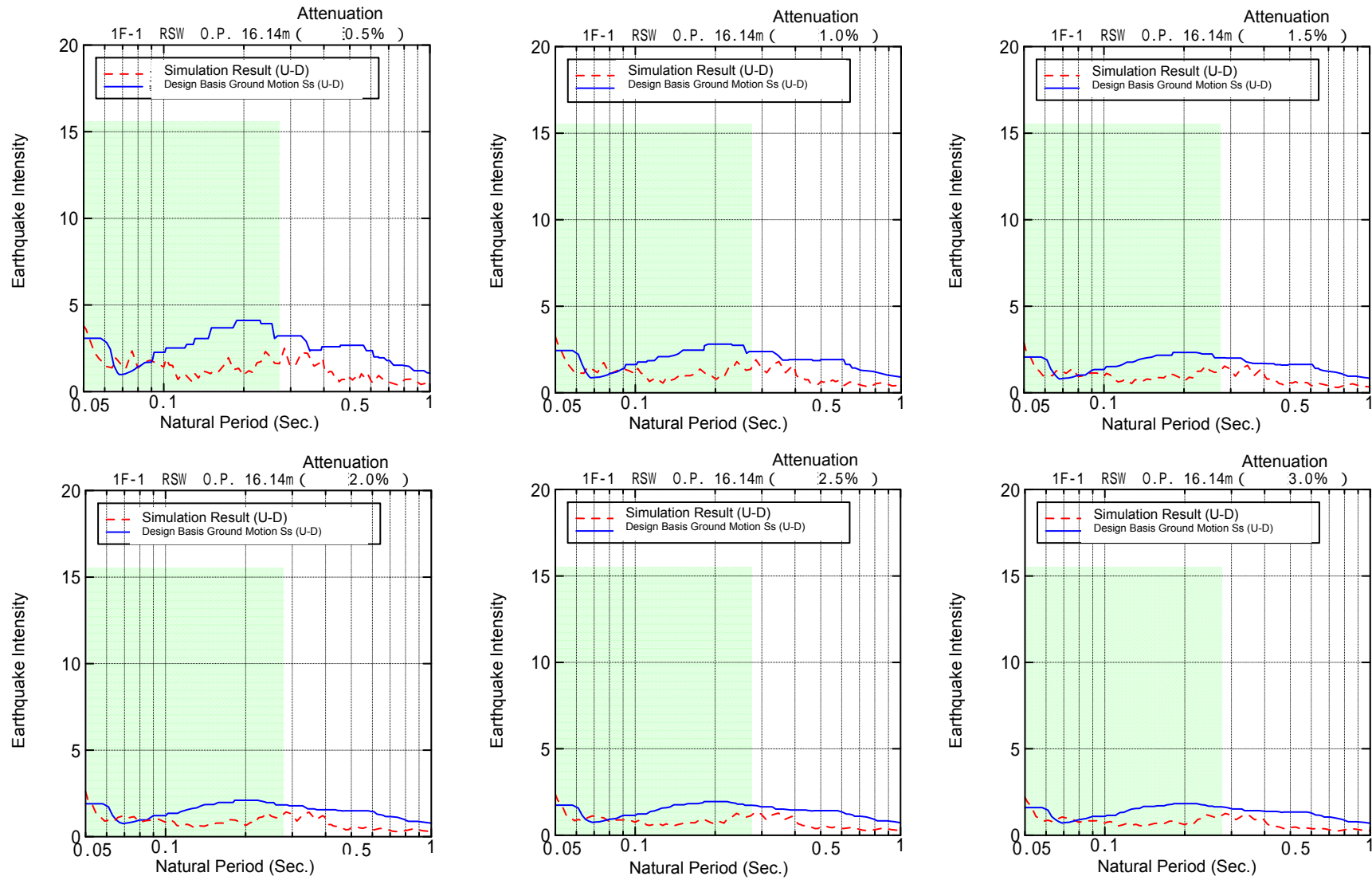

Figure-4.4.3.12 Reactor Shield Wall O.P. 16.14m Floor Response Spectrum ( Vertical direction )

#### 4.4.4 Result of Seismic Evaluation of Main Facilities

The result of seismic evaluation of main facilities is shown in Table-4.4.4.1. The summary of evaluation of each facility is shown in Attachment 1.

In regard with the earthquake of this time, the calculated figures for main facilities with significant functions with respect to safety, have all been confirmed to be below evaluation standard.

Table-4.4.4.1 Result of Seismic Evaluation ( Fukushima Daiichi Unit 1 )

Classification	Facility subject to evaluation	Evaluated part	Stress clarification	Calculated figure(MPa)	Evaluation standard <sup>1</sup> (MPa)	Evaluation method <sup>2</sup>
Shutdown	Reactor core support structure	Shroud support	Axial compressive stress	103	196	B
Cooling	Shutdown cooling system pump	Base bolt	Shear stress	8	127	B
	Shutdown cooling system pipe	pipes	Primary stress	228	414	B
Containment	Reactor pressure vessel	Base bolt	Tension stress	93	222	B
	Main steam pipe	Piping	Primary stress	269	374	B
	Reactor pressure vessel	Drywell	Membrane and bending stress	98	411 <sup>3</sup>	B

1: Tolerance for common status D stated in "Codes for nuclear power generation facilities : rules on design and construction for nuclear power plants JSME S NC1-2005" (corresponds to roughly the tolerance stress condition  $\sigma_s$  stated in "Nuclear power station seismic design technical guideline JEAG4601 · supplementary-1984")

2: A: simple evaluation, B: detailed evaluation

3: As it was operating normally at the time of the earthquake, the figure is an evaluation standard against the temperature of normal operation.

Classification	Facility subject to evaluation	Unit	Calculated figure	Evaluation standard
Stop	Control rod (insertability)	Fuel assembly relative displacement ( mm )	26.4	40.0

Reactor core support structure is a significant facility in terms of seismic safety, functioning as a support facility for scum and



removing decay heat from reactor cores. According to the reference document , readings on average output range monitor dropped rapidly after the reactor scum from earthquake, and it is confirmed that scum function operated normally. Also it is confirmed that water level within the reactor was within the range of normal level, and reactor pressure was also stably controlled. Therefore, it is considered that there were no abnormalities caused from earthquake damage to reactor core support structure, and this goes in line with the evaluation result.

According to the reference document, after the reactor scum, and until power loss of measuring instruments, no rapid change in temperature within the Primary Containment Vessel resulting from piping damage etc, is confirmed. Therefore, it is considered that there were no damage at reactor coolant pressure boundary such as Reactor Pressure Vessel and main steam piping, and this goes in line with the analysis result.

According to reference document, on March 12, drywell pressure was 0.6 ~ 0.8MPa [abs] during the period after Reactor Pressure Vessel break estimated by accident analysis code. After that, the pressure dropped rapidly due to ventilation. It is considered that Primary Containment Vessel maintained normal functions that act as pressure barrier in the case of reactor coolant pressure boundary break accident and this goes in line with the evaluation result.

According to the reference document, it is confirmed that control rods were all inserted at the time of the earthquake, and this goes in line with the evaluation result.

According to the reference document, cooling spent fuel pool by using shut down cooling system did not operate before the tsunami due to the water level of the spent fuel pool was full

level and the water temperature was 25 Celsius degree. Therefore, it is considered that shut down cooling system pump and pipe maintained normal functions immediately after the earthquake with the analysis result although it is not confirmed that shut down cooling system maintained normal functions from the operation record.

As a conclusion, it is considered that main facilities with significant functions with respect to safety, maintained its necessary safety function at the time of the earthquake and right after the earthquake.

“Analysis and evaluation of the operation record and accident record of Fukushima Daiichi Nuclear Power Station at the time of Tohoku-Chihou-Taiheiyo-Oki-Earthquake”  
May 23 2011 The Tokyo Electric Power Company, Incorporated

## 5. Summary

In regard with Unit 1 of Fukushima Daiichi Nuclear Power Station, which was in operation at the time of the Tohoku-Chihou-Taiheiyo-Oki Earthquake, the effects of the earthquake to the reactor building and significant instruments and piping in respect of seismic safety were evaluated.

With regard to the reactor buildings, the maximum response acceleration spectra and the maximum response on the shear skeleton curve from the earthquake response analysis result has been derived. Also, it was confirmed that there was sufficient margin against the evaluation standard ( $2.0 \times 10^{-3}$ ) for the maximum shear strain of the seismic wall used at seismic safety evaluation.

With respect to significant equipments and piping in terms of seismic safety, seismic load etc derived from large equipment coupled analysis based on the earthquake record, was compared with seismic load derived from seismic safety evaluation based on the Design Basis Ground Motion Ss, and if the seismic load derived from this time earthquake record is higher than the seismic load derived from the Design Basis Ground Motion Ss, the significant facility in terms of seismic safety was evaluated for the indices.

As a result, it was confirmed that calculated figures for main facilities significant in terms of safety to do with “Shutdown” and “Cooling” of the reactor, and “Containment” of the radioactive materials, were all within the evaluation standard. Also, these evaluation results match with the analysis result of plant status after the earthquake in the reference document, and therefore it is considered that main facilities with significant functions in terms of safety, was in a situation where they could maintain necessary safety function at the time of the earthquake and right after the earthquake. With regard to seismic load indices etc, analysis will be continued referring to setting conditions.

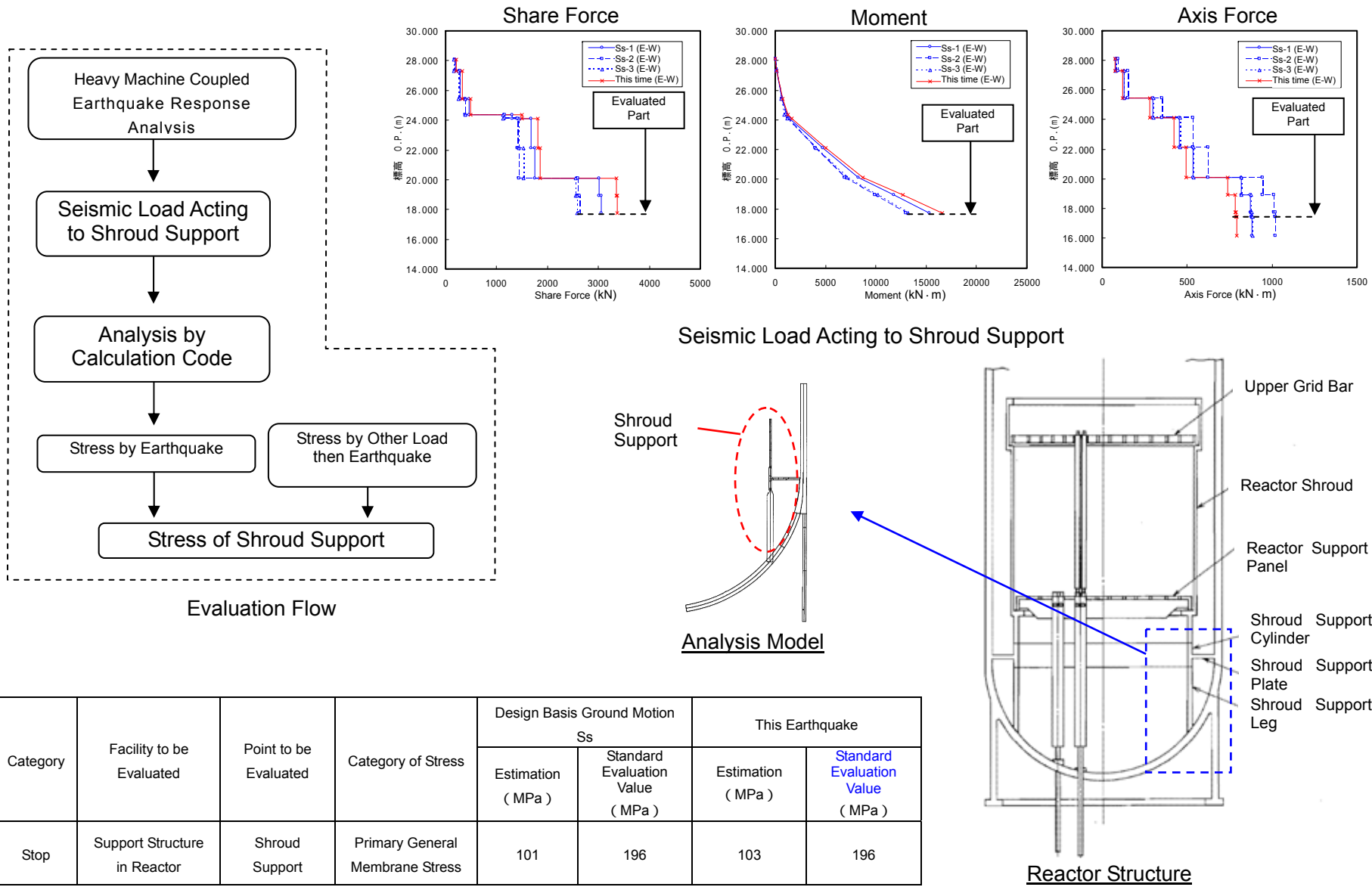

Category	Facility to be Evaluated	Point to be Evaluated	Category of Stress	Design Basis Ground Motion Ss		This Earthquake	
				Estimation (MPa)	Standard Evaluation Value (MPa)	Estimation (MPa)	Standard Evaluation Value (MPa)
Stop	Support Structure in Reactor	Shroud Support	Primary General Membrane Stress	101	196	103	196

Attachment Figure-1.1 Overview of Evaluation of Seismic Safety of Reactor Support Facility

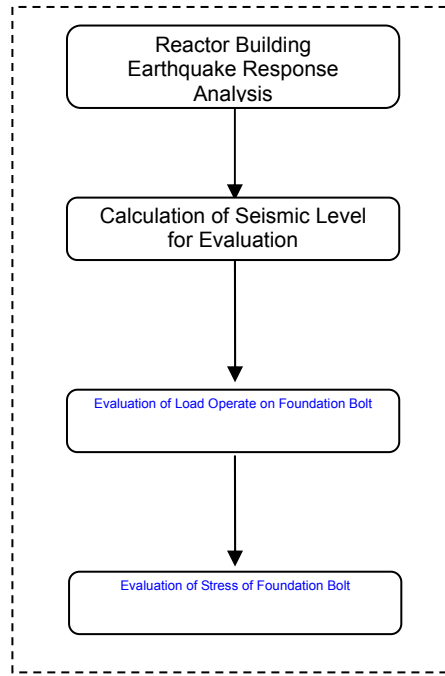

Evaluation Flow

Seismic Level for Evaluation

O.P. (m)	Horizontal Direction (NS/EW Envelope)		Vertical Direction	
	Main Shake	Design Basic Ground Motion Ss	Main Shake	Design Basic Ground Motion Ss
54.35	3.52	2.60	1.14	0.95
49.20	2.62	2.03	0.94	0.82
44.05	1.67	1.46	0.71	0.69
38.90	1.29	0.96	0.54	0.58
31.00	0.98	0.84	0.49	0.56
25.90	0.93	0.78	0.45	0.53
18.70	0.94	0.72	0.39	0.52
10.20	0.84	0.66	0.35	0.52
-1.23	0.57	0.60	0.32	0.51

Floor Level of Installation

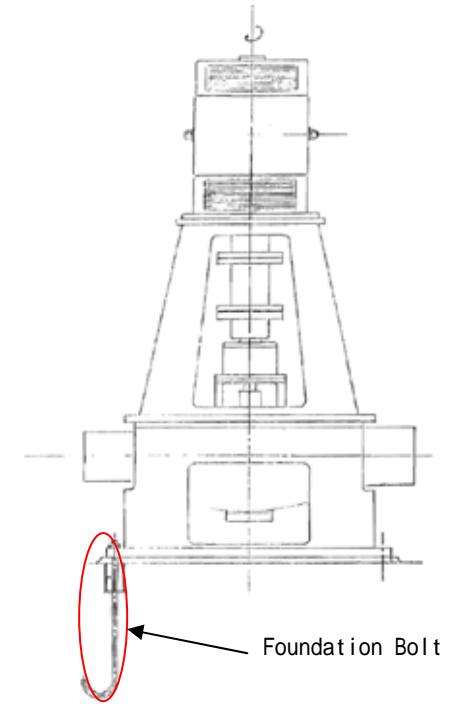

Structure of Shut Down Cooling System Pump

Category	Facility to be Evaluated	Point to be Evaluated	Category of Stress	Design Basis Ground Motion Ss		This Earthquake	
				Estimation (MPa)	Standard Evaluation Value (MPa)	Estimation (MPa)	Standard Evaluation Value (MPa)
Cooling	Shut Down Cooling System Pump	Foundation Bolt	Shear Stress	6	127	8	127

Attachment Figure-1.2 Overview of Evaluation of Seismic Safety of Shut Down Cooling System Pump

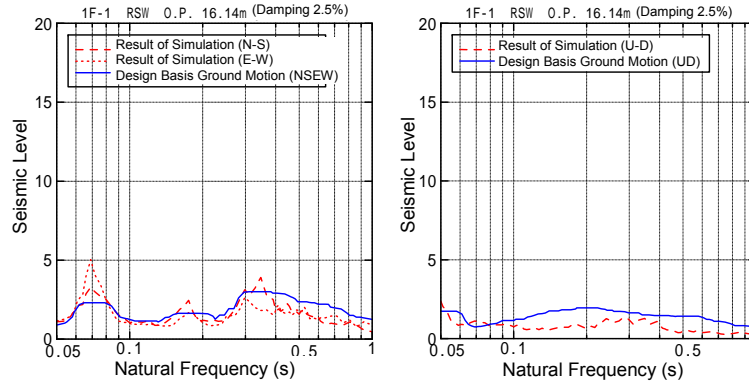
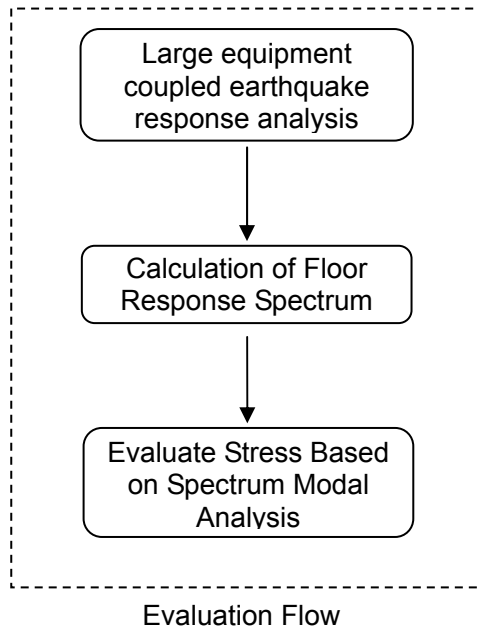
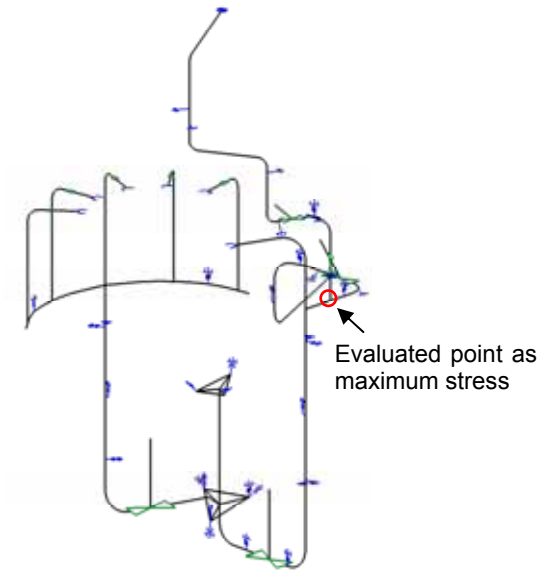

Image of input to anchor and support (blue mark in the Figure)



Plumbing Model of Shut Down Cooling System  
 Notice) Including part of Reactor Coolant Recirculation system due to analysis model condition.

Category	Facility to be Evaluated	Point to be Evaluated	Category of Stress	Design Basis Ground Motion Ss		This Earthquake	
				Estimation (MPa)	Standard Evaluation Value (MPa)	Estimation (MPa)	Standard Evaluation Value (MPa)
Cooling	Plumbing of Shut Down Cooling System	Plumbing	Primary Stress	229	414	228	414

: Floor response spectrum of vertical direction is almost less than that of design basis ground motion Ss, while that of horizontal direction is more than that of design basis ground motion Ss in partial frequency area. Thus, it seems that the calculated value for this earthquake did not exceed the design basis ground motion Ss.

Attachment Figure 1.3 Overview of Evaluation of Seismic Safety of Plumbing of Shut Down Cooling System

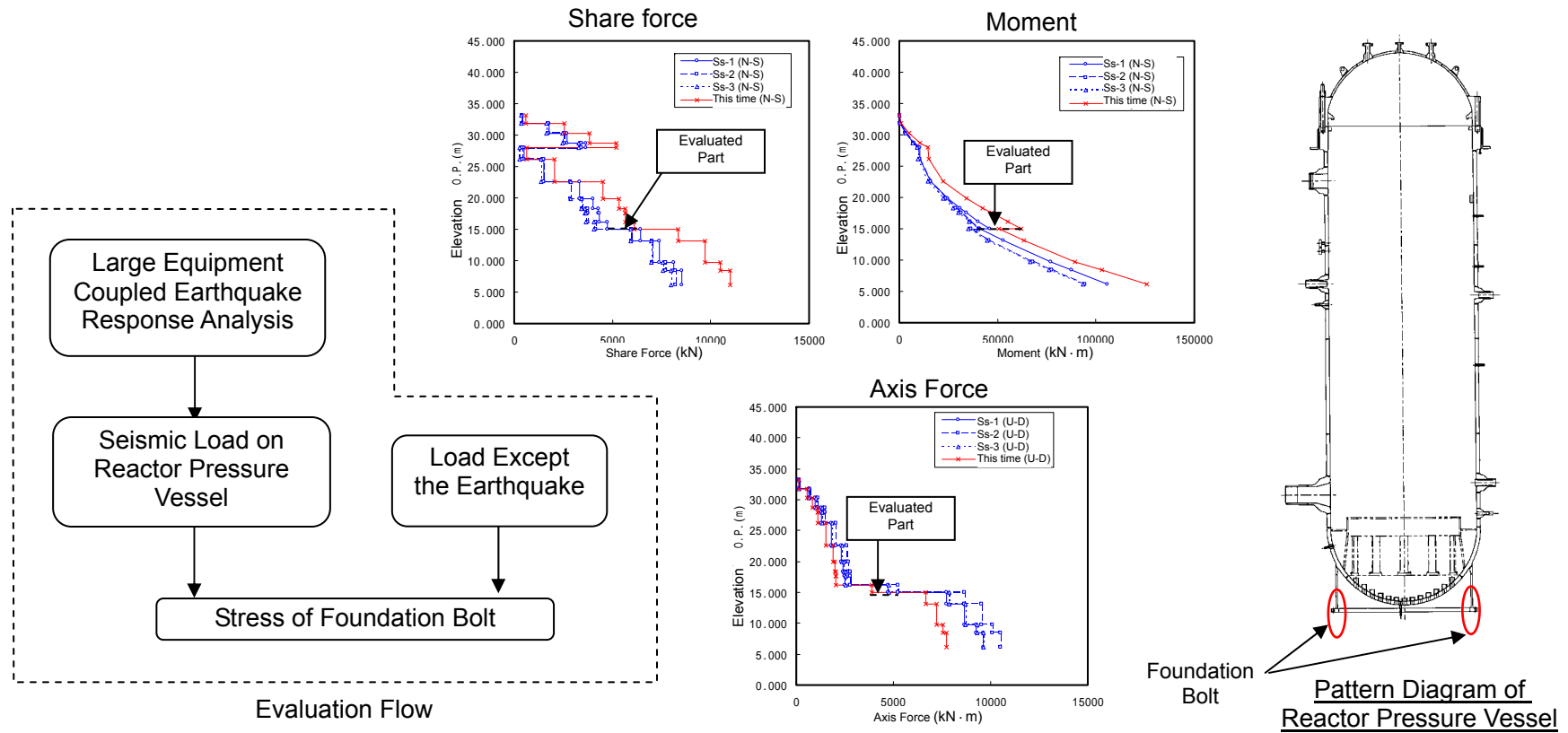

Category	Facility to be Evaluated	Point to be Evaluated	Category of Stress	Design Basis Ground Motion Ss		This Earthquake	
				Estimation (MPa)	Standard Evaluation Value (MPa)	Estimation (MPa)	Standard Evaluation Value (MPa)
Containment	Reactor Pressure Vessel	Foundation Bolt	Tension Stress	68	222	93	222

Attachment Figure-1.4 Overview of Evaluation of Seismic Safety of Reactor Pressure Vessel

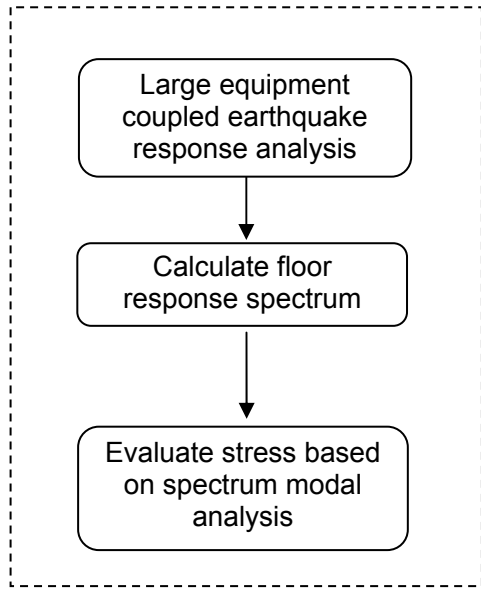

Evaluation Flow

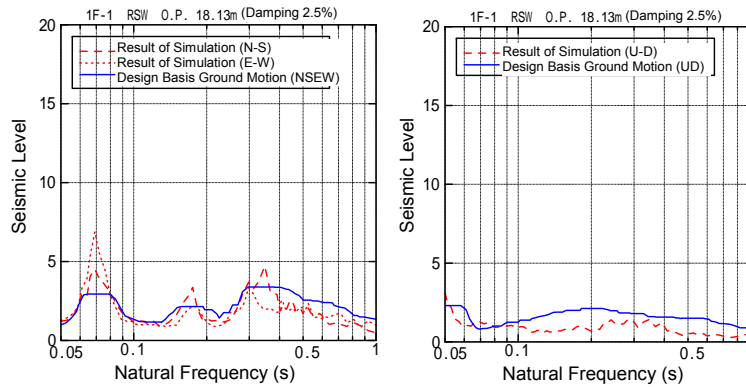
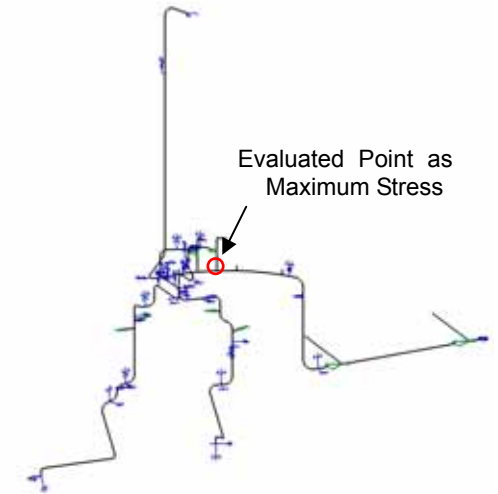

Image of input to anchor and support (blue mark in the Figure)



Plumbing model of main steam system

Category	Facility to be Evaluated	Point to be Evaluated	Category of Stress	Design Basis Ground Motion Ss		This Earthquake	
				Estimation (MPa)	Standard Evaluation Value (MPa)	Estimation (MPa)	Standard Evaluation Value (MPa)
Containment	Plumbing of Main Steam System	Plumbing	Primary Stress	287	374	269	374

: Floor response spectrum of vertical direction is almost less than that of design basis ground motion Ss, while that of horizontal direction is more than that of design basis ground motion Ss in partial frequency area. Thus, it seems that the calculated value for this earthquake did not exceed the design basis ground motion Ss.

Attachment Figure-1.5 Overview of Evaluation of Seismic Safety of Plumbing of Main Steam System



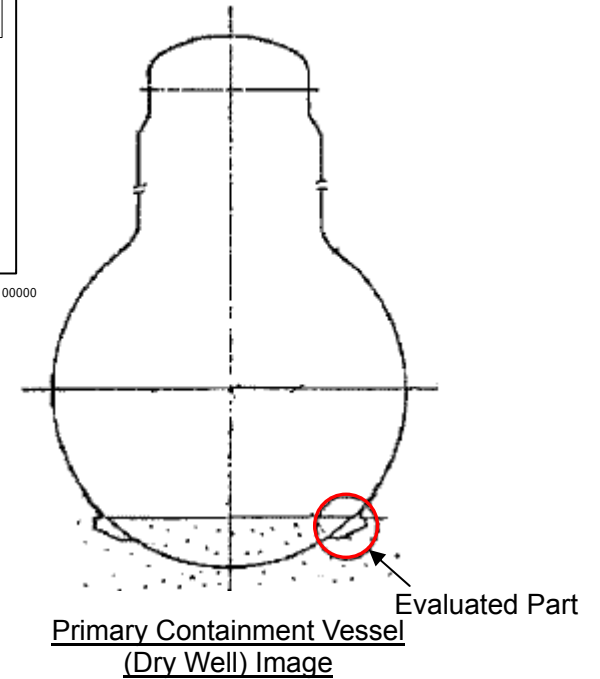
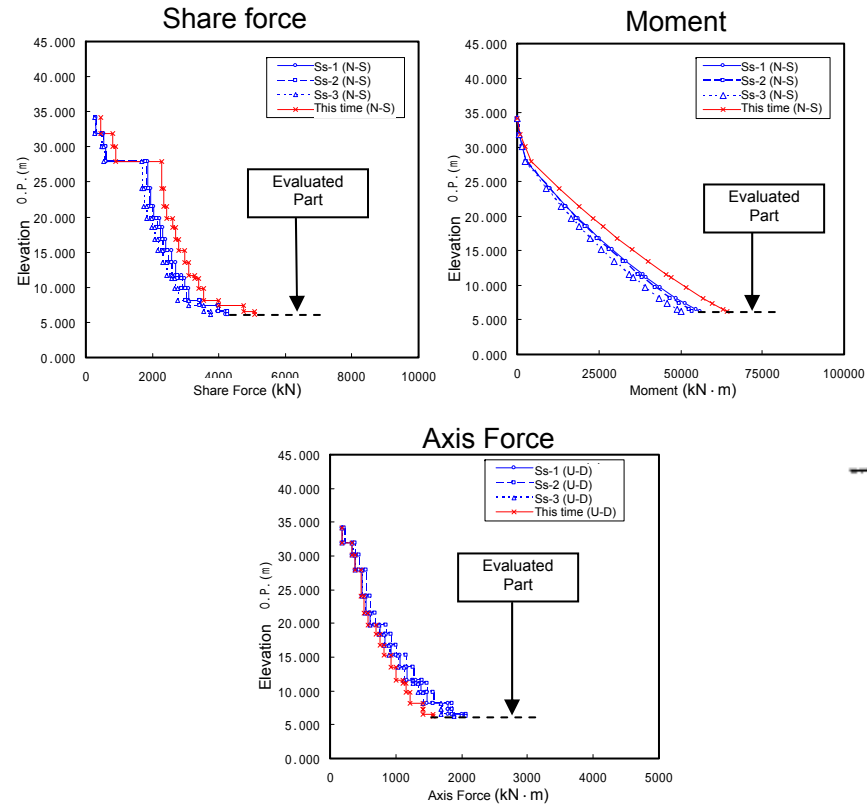
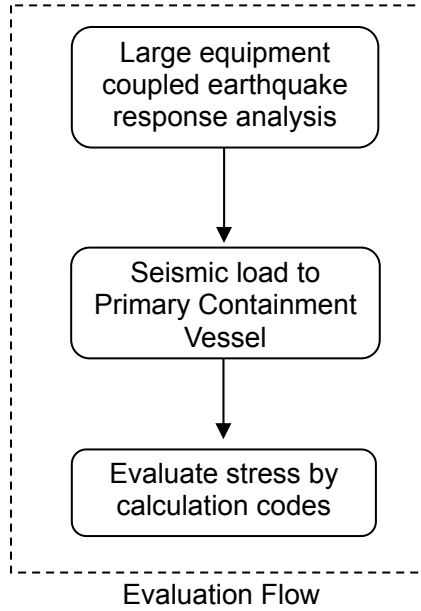

Category	Facility to be Evaluated	Point to be Evaluated	Category of Stress	Design Basis Ground Motion Ss		This Earthquake	
				Estimation (MPa)	Standard Evaluation Value (MPa)	Estimation (MPa)	Standard Evaluation Value (MPa)
Containment	PCV	Dry Well	Membrane & Bend Stress	113 <sup>1</sup>	382 <sup>2</sup>	98 <sup>1</sup>	411 <sup>2</sup>

1 : On the evaluation of this earthquake the load in the normal operation is used, however on the seismic safety evaluation the load in the replacement of fuel is used which is conservative. Thus, seismic load exceeded the simple evaluation, but the evaluated stress was below the design.

2 : In case of Design Basis Ground Motion, Ss, standard evaluation value was calculated based on the design temperature and in case of this earthquake based on the temperature in operation

Attachment Figure-1.6 Outline of Seismic Evaluation of Primary Containment Vessel

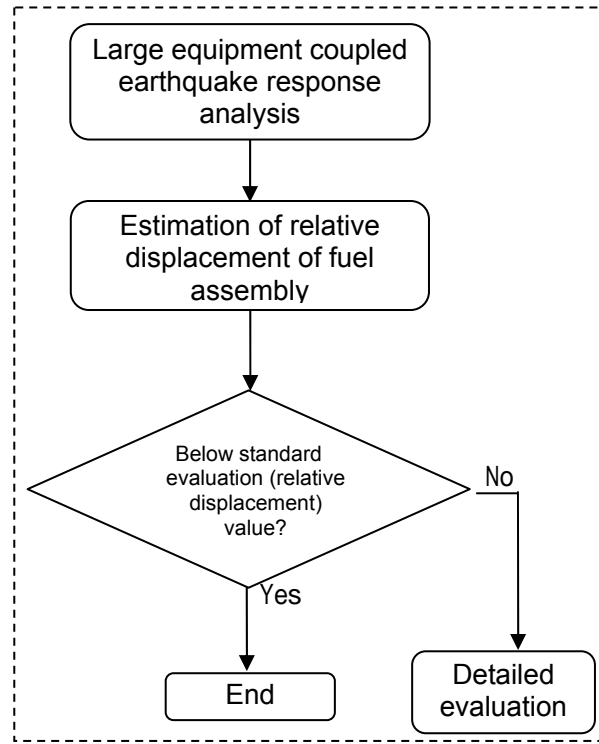

Evaluation Flow

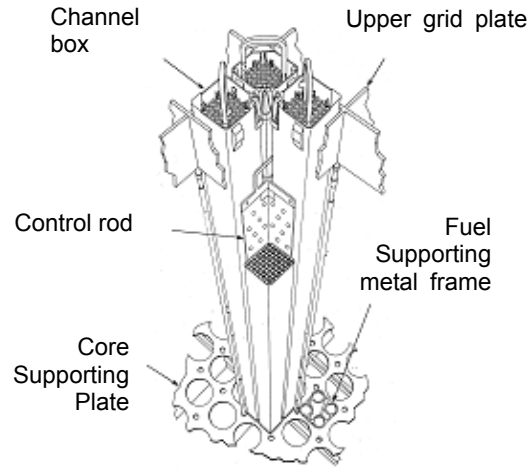
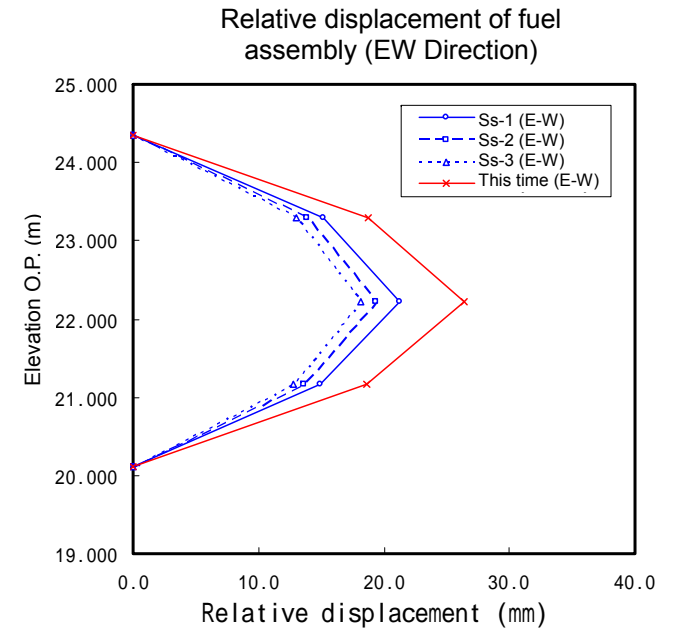

Image of Fuel Assembly



Category	Facility to be evaluated	Estimation of Fuel Assembly Relative Displacement ( mm )		Standard evaluation value ( mm )
		Design Basis Ground Motion Ss	Great East Japan Earthquake	
Stop	Control Rod (Insertion)	21.2	26.4	40.0

Attachment Figure-1.7 Outline of Seismic Evaluation of (Insertion) of Control Rod

**(Supplementary Document)**

**Sharp Peak on Short Period Side of Floor Response Spectrum  
in Simulation Analysis of Vertical Direction of Reactor  
Building**

Simulation analysis on Kashiwazaki-Kariwa Nuclear Power Station which responded to Niigataken Chu-etsuoki Earthquake indicated steep peaks on short period side of vertical floor spectrum of middle floors of reactor buildings. The reason was explained at the 17th Structure WG\* (July 24, 2008) as that these peaks derived from simulation analysis based on measurement record.

Although measurement record on the middle floors of Unit 1, Fukushima Daiichi Nuclear Power Station was not obtained in response to Tohoku-Taiheiyo-oki Earthquake, peaks which appeared in simulation analysis are considered to be the same phenomenon.

An abstract of the documents of the time is shown on the following pages for reference.

\* Structure Working Group, Seismic and Structural Subcommittee, Nuclear and Industrial Safety Subcommittee, Advisory Committee on Natural Resources and Energy

## Reason for the steep peak found in the simulation analysis - 1

Mr. Tajimi in his book "Theory of Structural Vibrations" cites that in case that a big building is on uniform ground the response is similar to that of two-layer ground which has subsurface one.

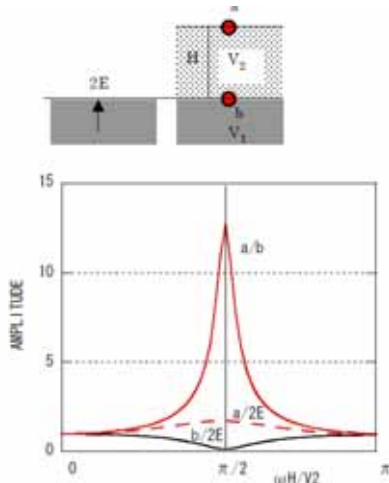

Frequency transfer function of two-layer ground

$$q = 0.5 \quad \alpha = (\sqrt{V_2} - \sqrt{V_1}) / \sqrt{V_1}$$

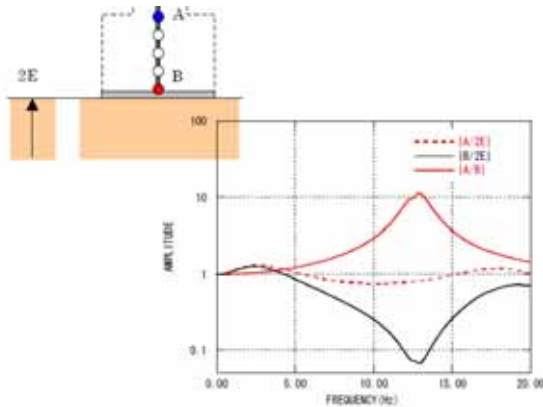

Frequency transfer function of the reactor building of Unit 5

Regarding the primary character frequency of the fixed foundation of the building, the foundation variation is nearly zero and concave shape as with the two-layer ground.

## Reason for the steep peak found in the simulation analysis - 2

Variation characteristic of the fixed foundation of the building explicitly reflects the observed record B\* ( ) of the foundation, which shape becomes concave.

In the simulation analysis, the response A is calculated by the formula "the observed record B\* ( ) \* the transfer function F ( ) (= A/B)". If the transfer function of the building does not reflect the actual phenomena, the peak does not synchronize with the valley and the wave of the primary variation frequency becomes remarkable, generating the steep peak. If the transfer function of the building reflects the actual phenomena, it does not generate the such peak.

Response A on the middle floor ( ) = Transfer function A of the building ( ) \* Observed record B\* ( )

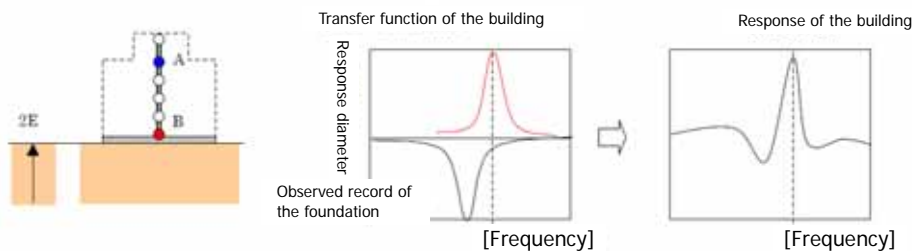

## **(Reference-1)**

### **Maximum Acceleration Value in the Seismic Data Recorded at the Reactor Building Base Mat of Fukushima Daiichi Nuclear Power Station**

Regarding the observation records at the base mat of reactor buildings of the Fukushima Daiichi Nuclear Power Station, the recordings were suspended approximately 130 to 150 seconds after the start of main quake. According to the following check and investigation, it is considered that the maximum acceleration have occurred during the recorded time range with the time history data, for each Unit.

- The earthquake recording equipment installed at the base mat records the maximum acceleration value, in addition to the time history data. Although the time history data of the main quake were not obtained after the suspension due to failure of the device, the maximum acceleration value after the suspension were newly obtained this time and checked.
- For the main quake, the maximum acceleration value during the time range until suspension (Record (1)), and the maximum acceleration value during the time range after the time of suspension (Record (2)) were obtained. The maximum acceleration values in each Record (1) and (2) are shown in Reference Table-1.1.
- Time ranges recorded in Record (1) and (2) are shown in Reference Figure-1.1. Since Record (2) is started 30 seconds before the time of suspension, the time ranges of Record (1) and (2) are overlapped for this 30 seconds.
- As shown in Reference Figure-1.1, relation of Record (1) and (2) are classified into 3 categories, [Category A to C], by the time that the maximum acceleration have occurred. The maximum acceleration at the observation points with Category A and B have occurred during the time range that the time history data were obtained.
- Classification of each observation point is shown in Reference Table-1.2. From Reference Table-1.2, all records are classified into Category A or B, and hence, the maximum acceleration have occurred during the time range that the time history data were obtained, as shown in Reference Figure-1.2 and 1.3.

Reference Table-1.1 Maximum Acceleration Value at R/B Base Mat in Main Quake

(Unit: Gal)

Unit	Observation Point	Maximum acceleration value until suspension (Record (1))			Maximum acceleration value after the time of suspension (Record (2))		
		North-south direction	East-west direction	Vertical direction	North-south direction	East-west direction	Vertical direction
1	1-R2	460.3	447.5	258.3	460.3	447.5	258.3
2	2-R2	348.3	549.8	302.0	348.3	549.8	302.0
3	3-R2	321.9	507.0	231.0	321.9	507.0	224.3
4	4-R2	280.7	319.0	199.6	280.7	319.0	199.6
5	5-R2	311.1	547.4	255.7	311.1	547.4	255.7
6	6-R2	298.1	443.8	170.7	298.1	443.8	170.7

Remark) Since the maximum acceleration values in the table are quick report values before the baseline amendment, these are different from the values in “The Report on the Analysis of Observed Seismic Data Collected at Fukushima Daiichi Nuclear Power Station pertaining to the Tohoku-Taiheiyo-Oki Earthquake (submitted on May 16, 2011)” by the amendment and round off.

Reference Table-1.2 Classification by the Comparison Between Record-(1) and (2)

Unit	Observation Point	Classification by the timing of maximum acceleration		
		North-south direction	East-west direction	Vertical direction
1	1-R2	B	B	B
2	2-R2	B	B	B
3	3-R2	B	B	A
4	4-R2	B	B	B
5	5-R2	B	B	B
6	6-R2	B	B	B

<Note>

A: Record (1) > Record (2) Maximum acceleration have occurred during the time range that the time history data were obtained.

B: Record (1) = Record (2) Maximum acceleration have occurred during the time range that the time history data were obtained.

C: Record (1) < Record (2) Maximum acceleration have occurred during the time range that the time history data were not obtained.

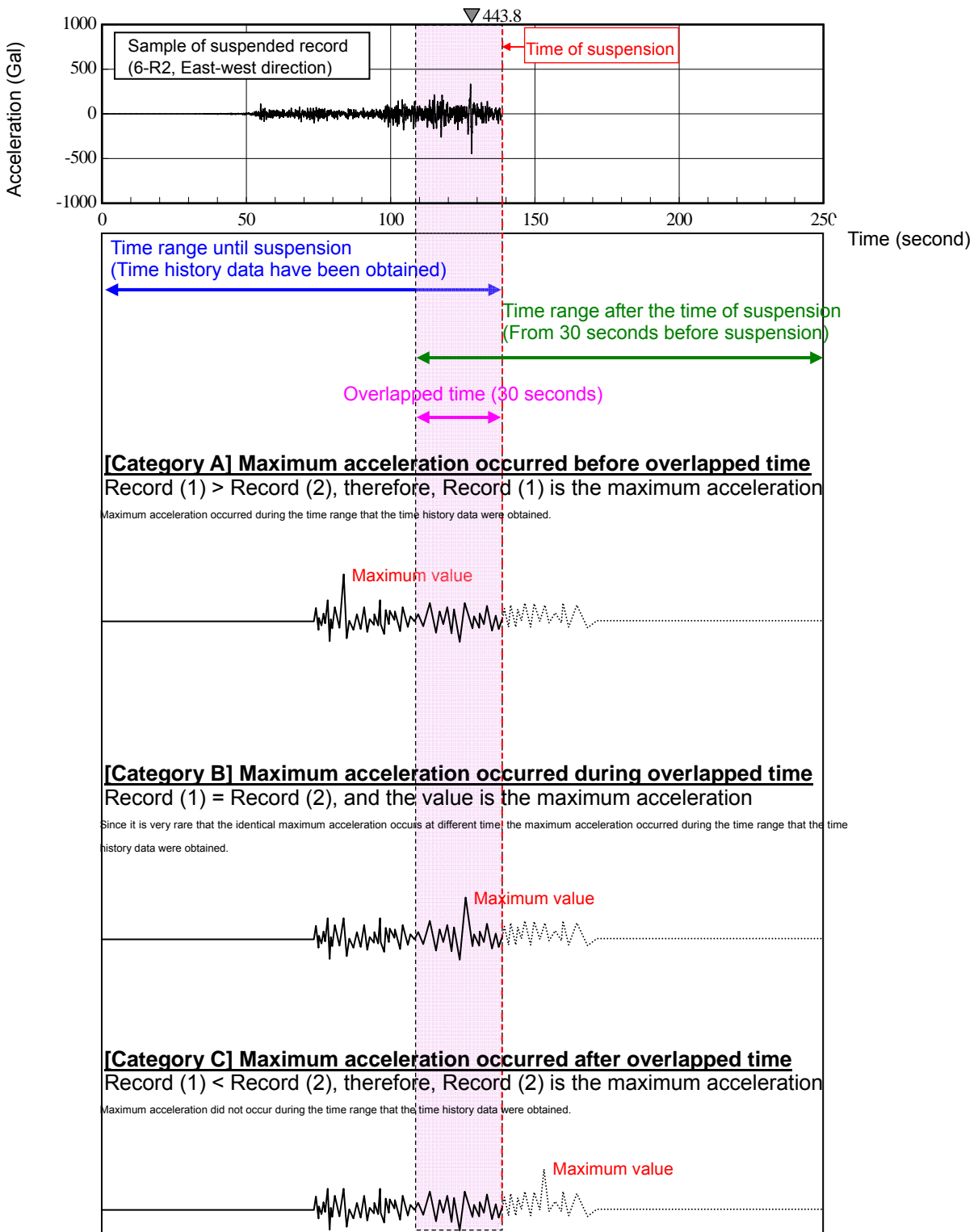

Reference Figure-1.1 Classification by the Time Range of Record (1) and (2) and the Time of Maximum Acceleration

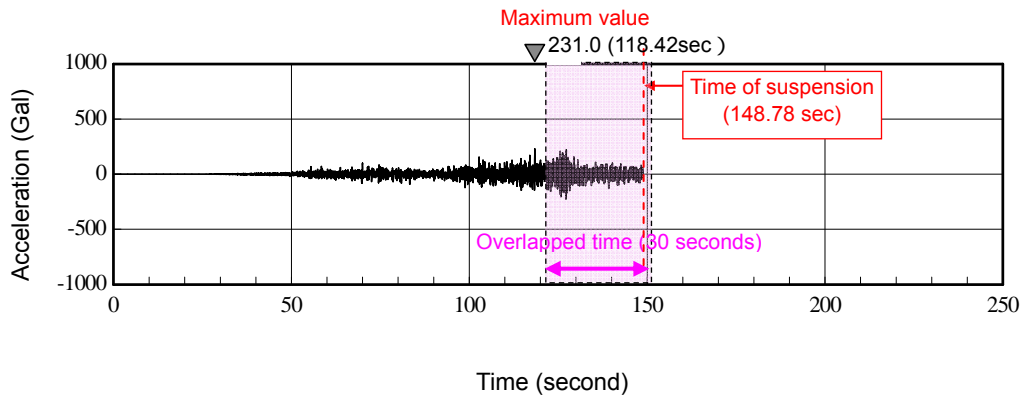

Reference Figure-1.2 Record of Category A (Point 3-R2, Vertical Direction)

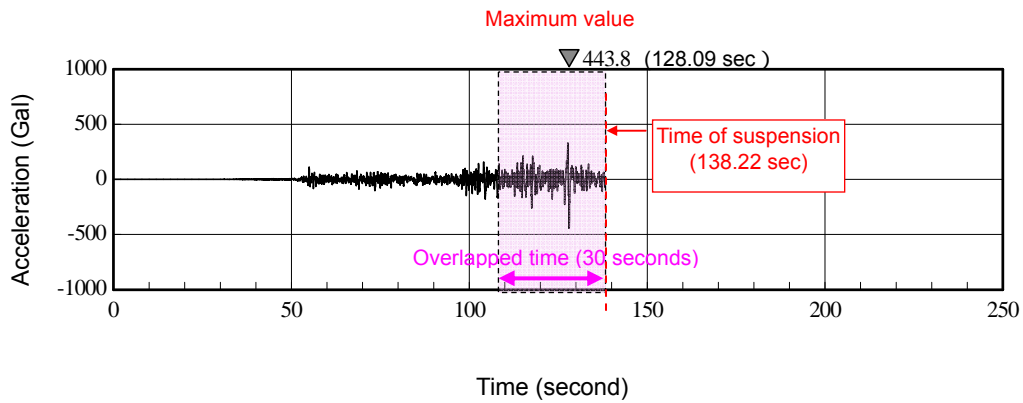

Reference Figure-1.3 Record of Category B (Point 6-R2, East-west Direction)



**(Reference-2)**

**Comparison of the Observation Records Collected by the Seismometers Installed at the Reactor Building Base Mat of Unit 6**

According to a part of observation records collected when the Earthquake occurred, recording was suspended approximately 130 to 150 seconds after recording was started due to a defect in the device to record seismic data from seismometers.

Among observation points which stopped halfway to recording, only Observation Point 6-R2 has recorded entirely near Observation Point P3, we compared the data between Observation Point 6-R2 and P3. Location of seismic observation points at the base mat of reactor buildings of Unit 6 is shown at Reference Figure 2.1.

Reference Figure 2.2 shows comparison of acceleration time history waveforms between Observation Point 6-R2 and P3, and Reference Figure 2.3 shows comparison of acceleration response spectra between Observation Point 6-R2 and P3.

According to Reference Figures 2.2 and 2.3, we have confirmed that maximum response acceleration and acceleration response spectra are in the same range

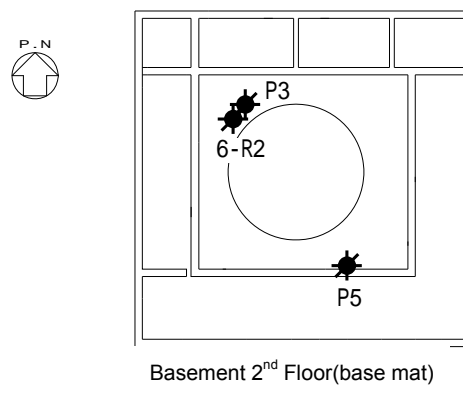

Reference Figure-2.1 Location of Seismometers  
( Base Mat of Reactor Buildings of Unit 6 )

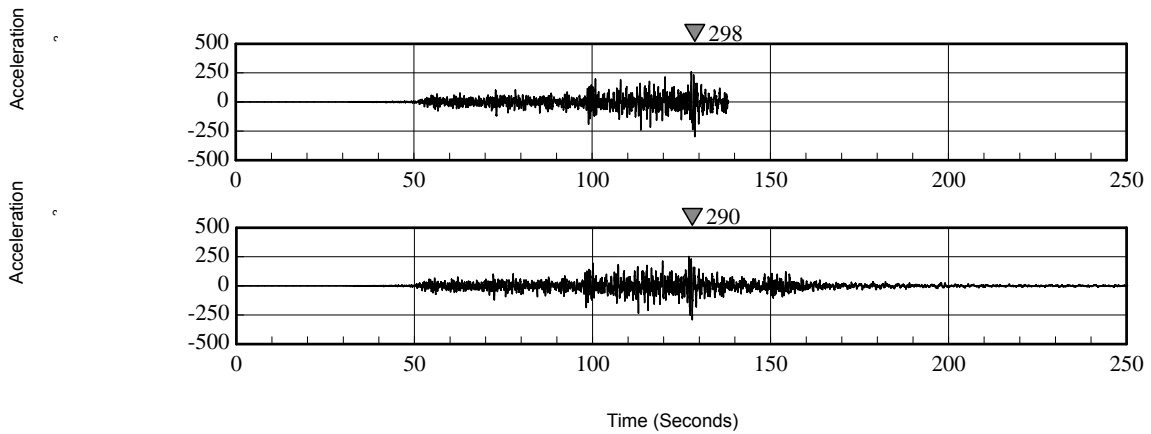

(a) North-South Direction

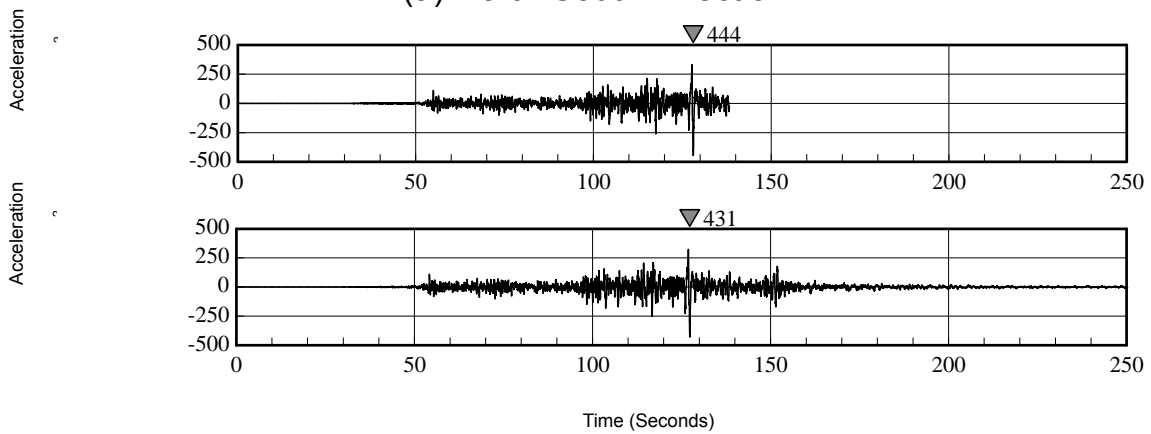

(b) East-West Direction

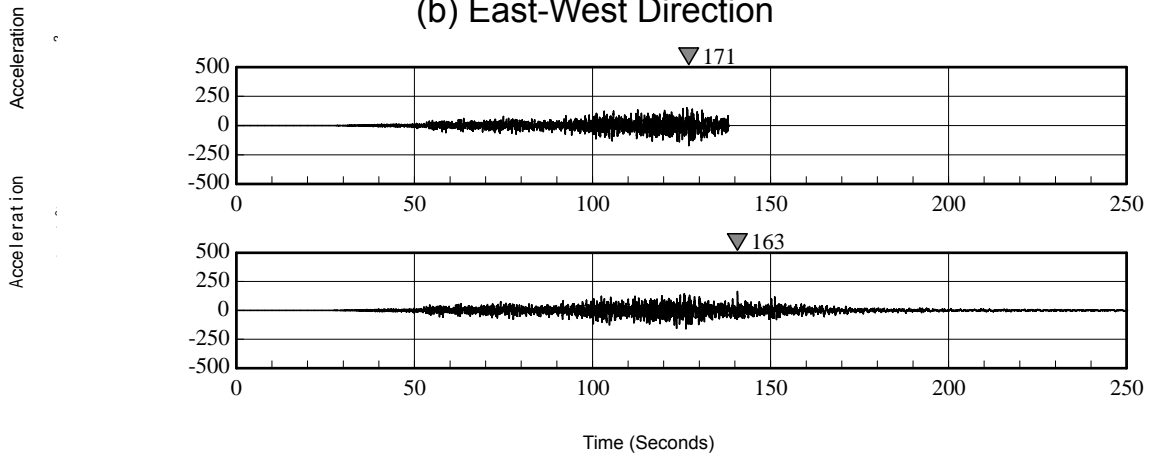

(c) Vertical Direction

Notice: Upper figure is the data collected at Observation Point 6-R2,  
and lower figure is at Observation Point P3.

Reference Figure-2.2 Comparison of Acceleration Time History Waveforms at  
Between Vicinal Observation Points  
( Base Mat of Reactor Buildings of Unit 6 )

Observation Point 6-R2  
Observation Point P3

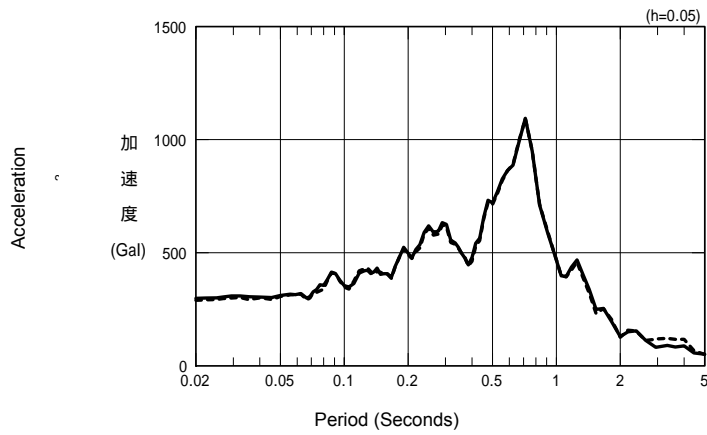

(a) North-South Direction

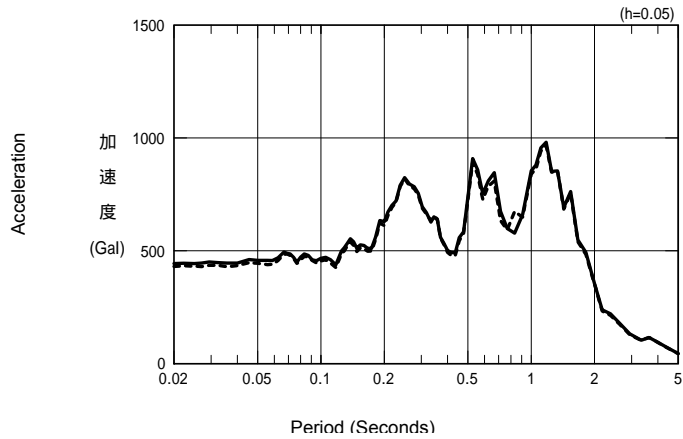

(b) East-West Direction

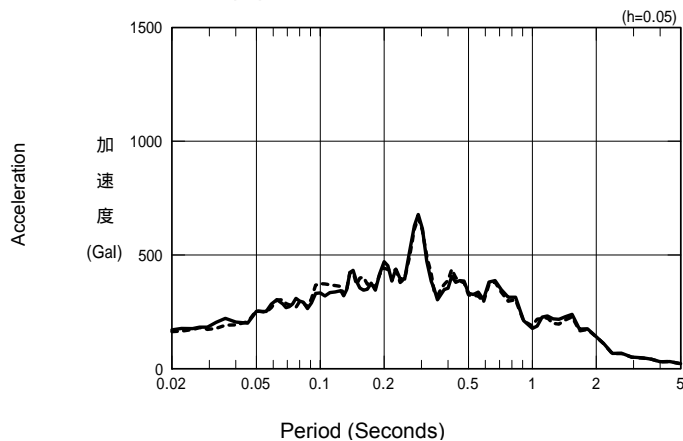

(c) Vertical Direction

Reference Figure-2.3 Comparison of Acceleration Response Spectra Between Vicinal Observation Points (h=0.05) ( Base Mat of Reactor Buildings of Unit 6 )

**(Reference-3)**

**Part Where the Curvature in Elastic Response Analysis Exceeds the First Break Point on the Bending Skeleton Curve**

The elastoplastic response analysis was conducted in the simulation analysis of the Unit 1 Reactor Building of the Fukushima Daiichi Nuclear Power Station, since the curvature in some of the seismic wall exceeds the first break point on the bending skeleton curve, according to the result of the elastic response analysis.

Reference Figure-3.1 shows the maximum response value of the first basement in north-south direction, as an example of the part where the curvature in elastic response analysis exceeds the first break point on the bending skeleton curve

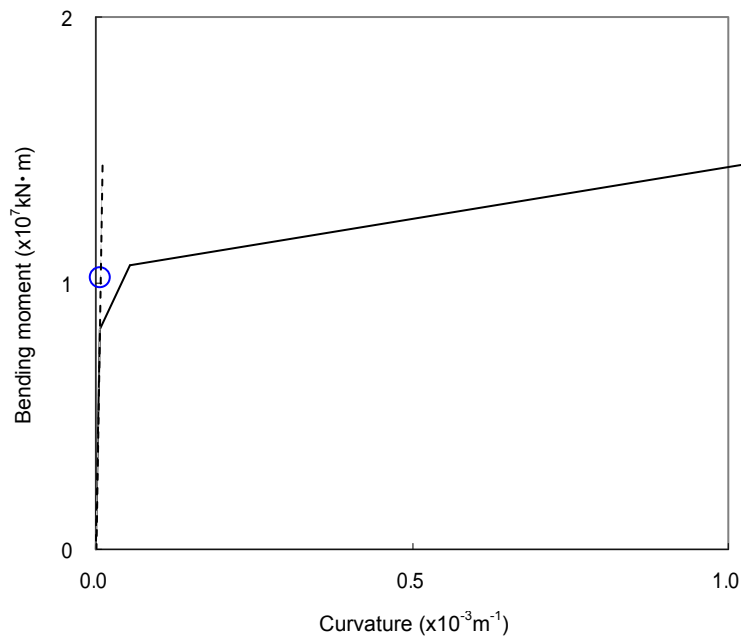

Reference Figure-3.1 Maximum Response Value  
(First basement, North-south direction)

**(Reference-4)**

**Comparison Between the Seismic Motion for Input of Earthquake Response Simulation and the Observed Record**

In the horizontal direction (north-south and east-west directions) analyses in the earthquake response simulation of the Fukushima Daiichi Nuclear Power Station Unit 1 reactor building, the elastoplastic analysis (time history analysis) has been conducted by making the equivalent ground responses.

The observed record on the base mat and the analyses results are compared below.

In the following pages, superimposed diagrams (north-south direction and east-west direction) of acceleration time history wave of the analysis result and the observed record (1-R2) on the base mat are shown in Reference Figure-4.1, and their acceleration response spectrum diagrams (north-south direction and east-west direction) are shown in Reference Figure-4.2.

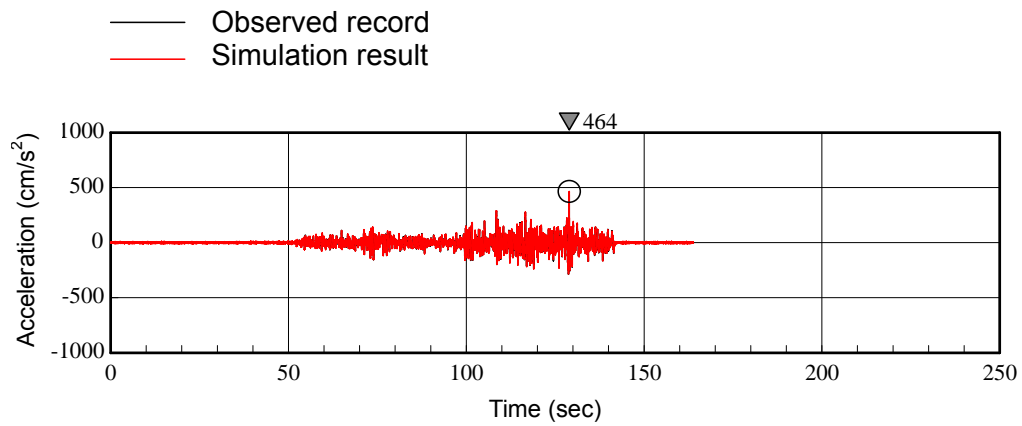

Remark) "o" indicates the maximum value.  
Recording has been terminated at 141 seconds after the start.

(a) North-south direction

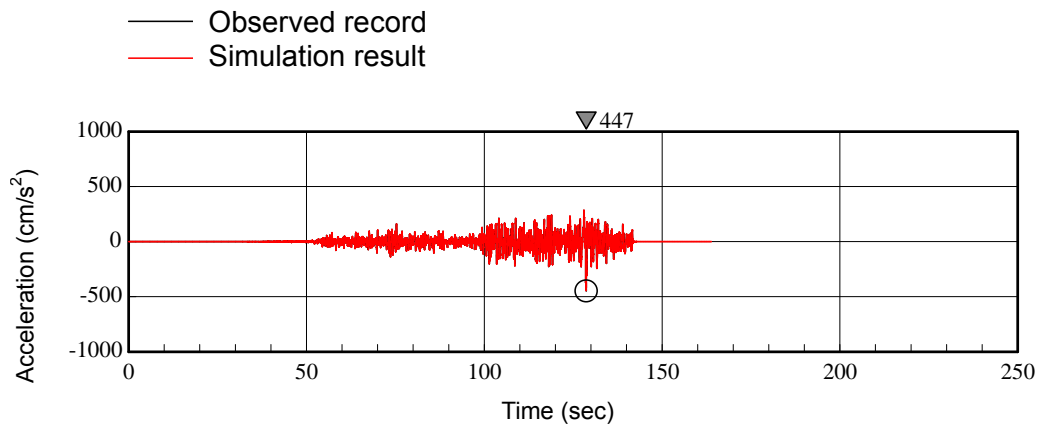

Remark) "o" indicates the maximum value.  
Recording has been terminated at 141 seconds after the start.

(b) East-west direction

Reference Figure-4.1

Comparison of Acceleration Time History Wave on the Base Mat of the Unit 1 Reactor Building - Observed Record (1-R2) and Response Wave Based Upon Simulation Analysis Result

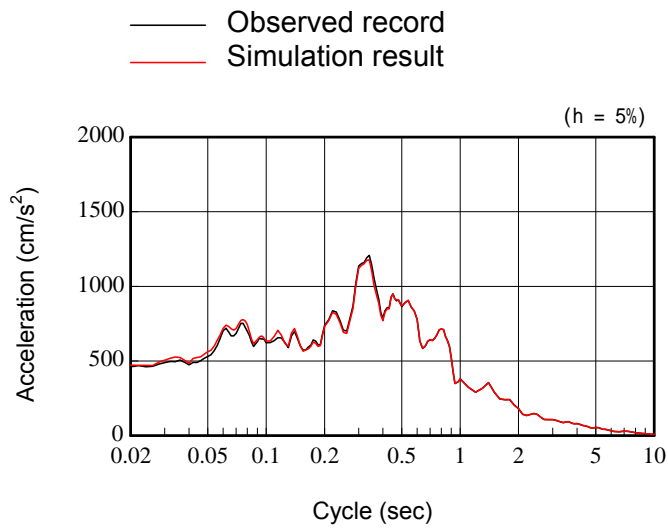

(a) North-south direction

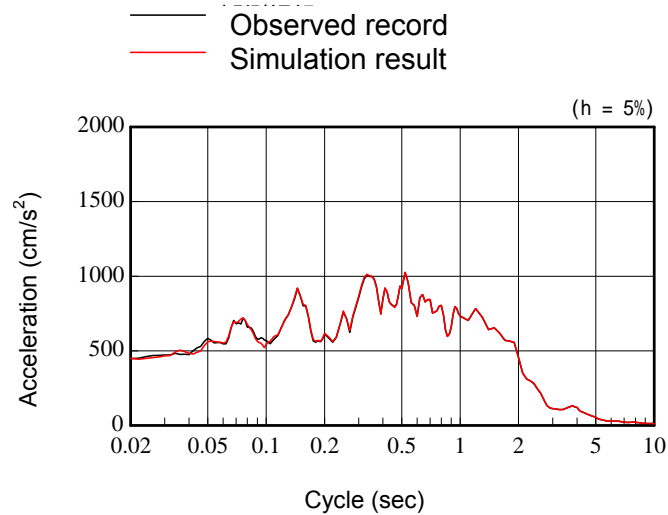

(b) East-west direction

Reference Figure-4.2

Comparison of Acceleration Response Spectrum on the Base Mat of the Unit 1 Reactor Building - Observed Record (1-R2) and Response Wave Based Upon Simulation Analysis Result

**(Reference-5)**

**Comparison of Evaluation Results for Major Facilities Against the Design Basis Ground Motion (Ss) and This Time Earthquake**

Reference Table-5.1 Comparison of Structural Strength Evaluation Results

Target facility	Evaluation part	Design basis ground motion: Ss				This time earthquake			
		Stress type	Calculated value (MPa)	Reference value (MPa)	Evaluation method	Stress type	Calculated value (MPa)	Reference value (MPa)	Evaluation method
Reactor Pressure Vessel	Foundation bolt	Tension	68	222	Detail	Tension	93	222	Detail
Primary Containment Vessel	Drywell	Envelope + Bending	113 <sup>*1</sup>	382	Detail	Envelope + Bending	98 <sup>*1</sup>	411 <sup>*2</sup>	Detail
Core supporting structure	Shroud support	Axis Compression	101	196	Detail	Axis Compression	103	196	Detail
Shut Down Cooling System: Pump	Foundation bolt	Shear	6	127	Detail	Shear	8	127	Detail
Shut Down Cooling System : Pipe	Pipe	Primary	229 <sup>*3</sup>	414	Detail	Primary	228 <sup>*3</sup>	414	Detail
Main steam line pipe	Pipe	Primary	287 <sup>*3</sup>	374	Detail	Primary	269 <sup>*3</sup>	374	Detail

Reference Table-5.2 Comparison of Evaluation Results of Dynamic Function Maintenance

Target facility	Calculated value of relative displacement of fuel assembly (mm)		Reference value (mm)
	Design basis ground motion: Ss	This earthquake	
Control rod (Insertability)	21.2	26.4	40.0

- \*1 The evaluation of this earthquake is made using the load in normal operation, while the conservative load at the time of fuel exchanges is reflected in the evaluation of the earthquake-proof safety. Therefore, although seismic load in this earthquake was heavier, calculated values in this earthquake were smaller.
- \*2 While evaluation standard values of design basis ground motion were calculated based on design temperature, those of this earthquake were based on temperature at the time of operation.
- \*3 Horizontal floor response spectra of this earthquake are greater than those of design basis ground motions (Ss) in some periodic band, however, vertical floor response spectra are largely less than those of basis ground motions (Ss), therefore, it is estimated that the calculated values of this earthquake are less than those of design basis ground motions (Ss).



**(Reference Attachment - 1)**

**Function Confirmed Acceleration of Pump of Emergency Core Cooling System (ECCS)**

Machine types of pumps of Emergency Core Cooling System in Unit 1 of Fukushima Daiichi Nuclear Power Station and function confirmed acceleration of dynamic equipments shown in “Technical Guideline for Seismic Design of Nuclear Power Station JEAG4601-1991 addendum” etc. are shown in the Reference Attachment Table-1.1. The maximum response acceleration of reactor building based on simulation analyses results of observed records is shown in the Reference Attachment Figure-1.1.

Reference Attachment Table-1.1 Machine Type of Pump of Emergency Core Cooling System and Function Confirmed Acceleration ( Fukushima Daiichi Unit 1 )

Facility	Location	Type	Machine Type	Function Confirmed Acceleration	
				Horizontal (G <sup>1</sup> )	Vertical (G <sup>1</sup> )
Shut Down Cooling System: Pump	1 <sup>st</sup> floor of Reactor Building ( O.P.10.20m )	Vertical Shaft Pump	Vertical, Mono Step, Floor Installed Pump	10.0	1.0 <sup>*2</sup>
Primary Containment Vessel Spray System: Pump	Basement of Reactor Building ( O.P.-1.23m )				
Reactor Spray System: Pump					
High Pressure Water Injection: Pump	Basement of Reactor Building ( O.P.-1.23m )	Horizontal Shaft Pump	Horizontal, Multi-Steps, Centrifugal Pump	3.2 ( Right angle to the axis ) 1.4 ( Axis direction )	1.0 <sup>*2</sup>

\*1 : G=9.80665 ( m/s<sup>2</sup> )

\*2 : Vertical direction acceleration is regarded as 1.0 G when a floating phenomena of internal parts is not necessary to be considered.

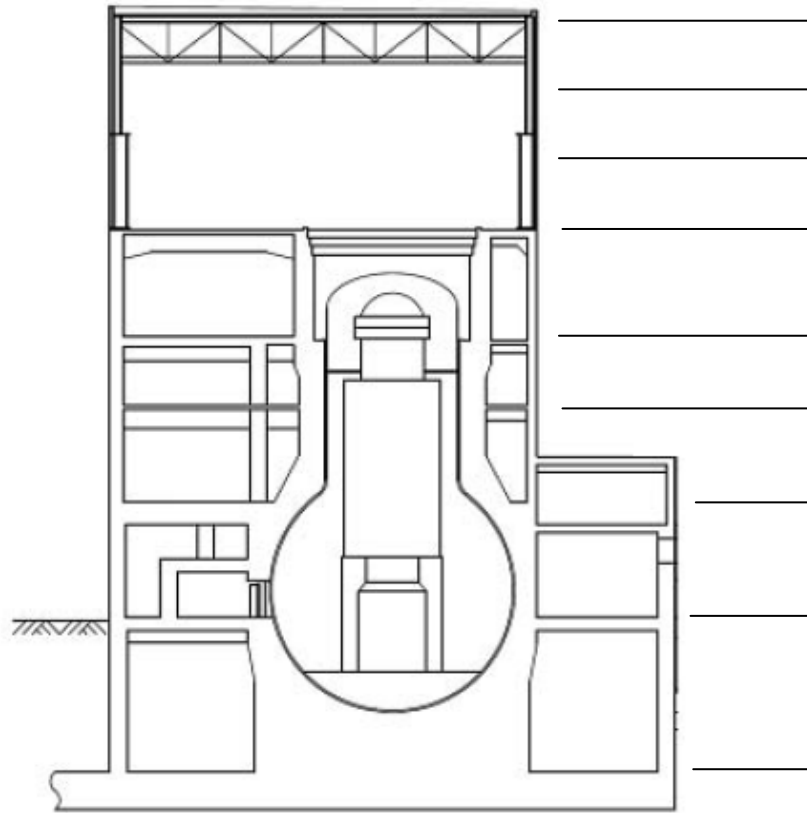

O.P. ( m )	Horizontal (NS/EW envelope )		Vertical	
	Main Quake	Design Basis Ground Motion Ss	Main Shock	Design Basis Ground Motion Ss
54.35	2.93	2.17	0.95	0.79
49.20	2.19	1.69	0.79	0.69
44.05	1.39	1.22	0.59	0.57
38.90	1.08	0.80	0.45	0.49
31.00	0.81	0.70	0.41	0.47
25.90	0.78	0.65	0.38	0.44
18.70	0.79	0.60	0.33	0.43
10.20	0.70	0.55	0.29	0.43
-1.23	0.47	0.50	0.27	0.42

Reference Attachment Figure-1.1 Maximum Response Acceleration of Reactor Building

**(Reference Attachment - 2)**

**Seismic Safety Evaluation of Supporting Legs for the Suppression Chamber**

Quake resistance of supporting legs for the suppression chamber of Unit 1 was evaluated using the seismic load calculated by this simulation analyses.

As a result it was confirmed that regarding this earthquake calculated values of supporting legs for the suppression chamber are below the reference values.

Reference Attachment Table -2.1  
Evaluation Results of Quake Resistance of Supporting Legs for the Suppression Chamber

Evaluated Part	Stress Type	Calculated Values	Reference Values	Remarks
Pillar (Outer Pillar)	Combination	0.64	1.0	Compression + bending
		0.46	1.0	Compression + bending

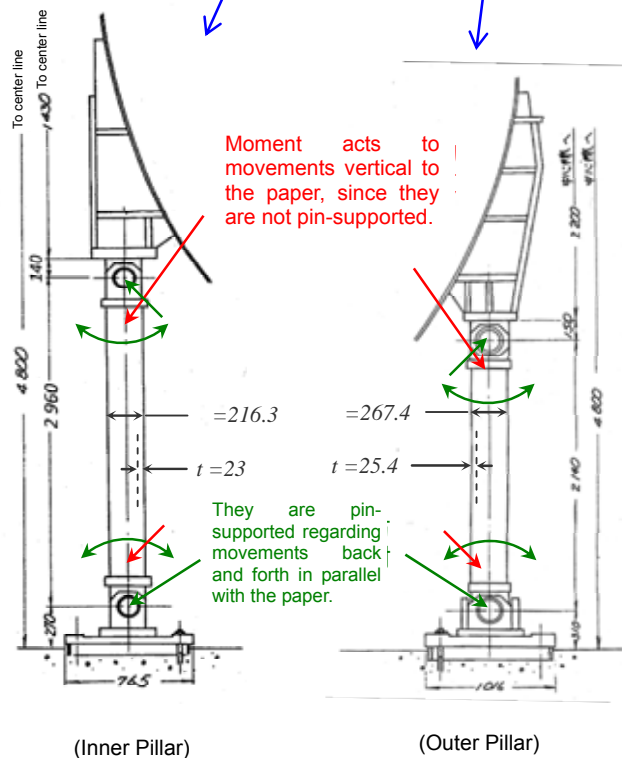
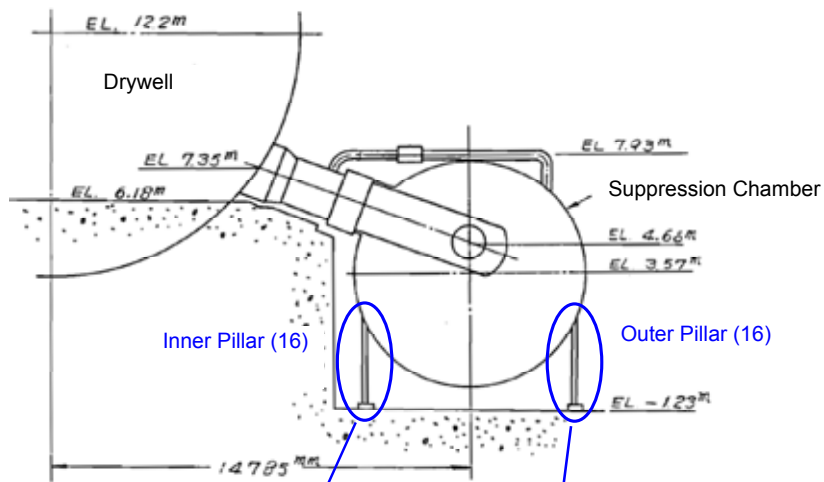

Moment acts to movements vertical to the paper, since they are not pin-supported.

They are pin-supported regarding movements back and forth in parallel with the paper.

: Evaluated points

Reference Attachment Figure -2.1  
Structure of Supporting Legs for the Suppression Chamber

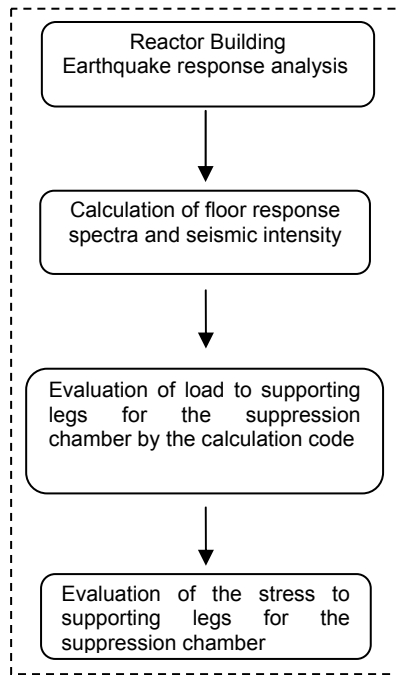

Evaluation flow

Compare the load based on the static analysis the seismic intensity at the installment level is input to with that based on the dynamic analysis (spectrum modal analysis), and the larger value is used for the evaluation.

Seismic intensity at the level of the suppression chamber

Height O.P.(m)	Horizontal (NS/EW envelop )	Vertical
-1.23 (on the base bat)	0.47	0.27

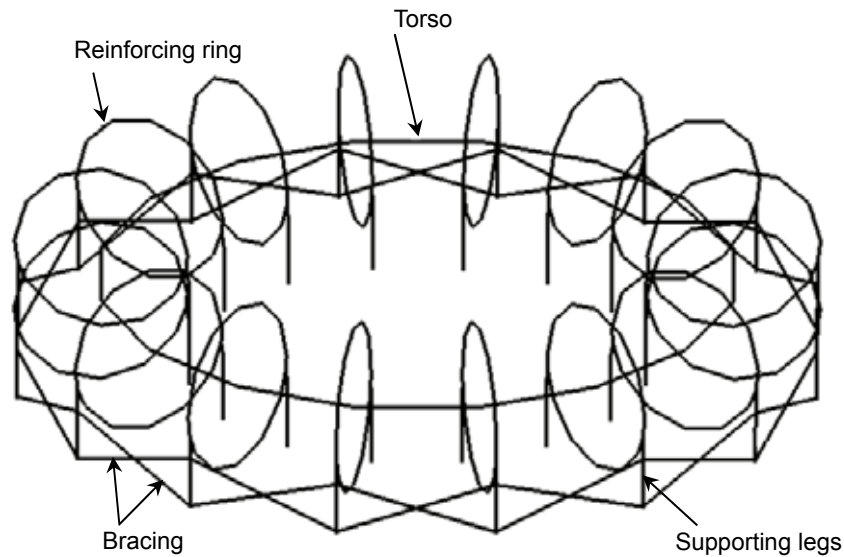

Analysis model

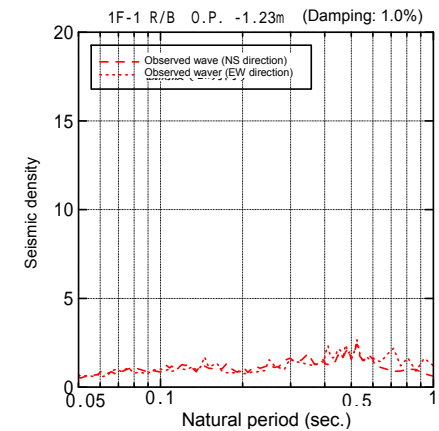

Floor response spectra (horizontal) used for evaluation

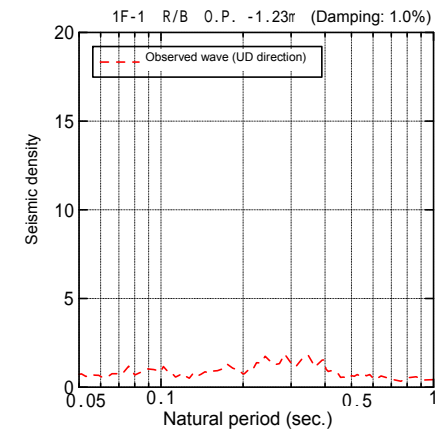

Floor response spectra (vertical) used for evaluation

Reference Attachment Figure -2.2 Overview of Seismic Safety Evaluation of Supporting Legs for Suppression Chamber