

Arrival times of tsunami at the Fukushima Daiichi Nuclear Power Station site

1. Overview

In the “Fukushima Nuclear Accidents Investigation Report,” TEPCO used the time of about 15:27 on March 11th, 2011, as the time of the first wave arrival and about 15:35 as the time of the second wave arrival. These are the times when the waves arrived at the wave height meter, about 1.3 km off the site. But this wave height meter had no time correction function in its built-in clock. There was a possibility of incorrect time recording; thus it was not possible to specify the exact times of the tsunami waves arriving at the Fukushima Daiichi Nuclear Power Station site.

The following analyses and evaluations were newly done in order to provide the exact timings of the tsunami wave arrivals at the Fukushima Daiichi Nuclear Power Station site.

Analysis I: accuracy of times recorded by the wave height meter

Analysis II: analysis of tsunami wave arrival timing based on continuous photos taken (built-in timer of the camera is corrected, along with the wave form time history recorded by the wave height meter)

Analysis III: tsunami arrival timing based on the plant data recorded

Although these analyses cannot explain the exact timing in the order of seconds, from the analyses of I to III above, the arrival timing of the tsunami (second wave) was concluded to be sometime between 15:36 and 15:37, hereafter described as the 15:36 level.

2. Definitions of terminology

To analyze the wave height meter records and photos in detail, the following definitions were used for the terms related to the tsunami that hit the Fukushima Daiichi Nuclear Power Station.

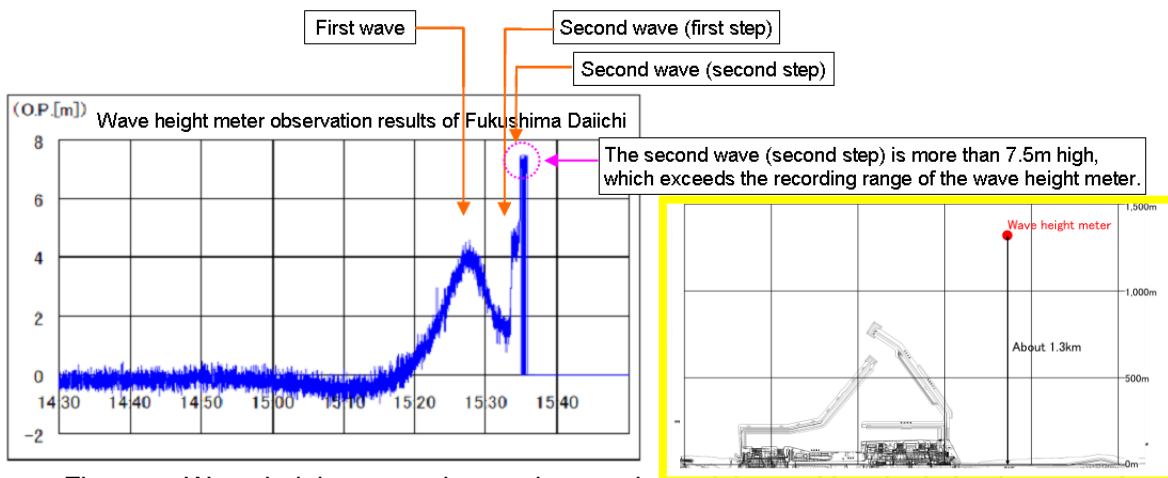

Refer to Chapter 9 of the Main Body of Progress Report for the usage of O.P.

3. Approach for the analyses

The following approach has been taken to analyze the tsunami arrival timing at the Fukushima Daiichi Nuclear Power Station site. The results of analyses are given in later sections: the results of analyses I and II as “Analysis by the use of wave height meter records and photos” and those of analysis III as “Analysis using plant data.”

In Analysis I, the accuracy of the wave height meter built-in clock was analyzed, which was known to have inaccuracies. Seismometers installed on each unit of the Fukushima Daiichi Nuclear Power Station, which had been calibrated on the each hour, were used as the reference and compared with the water pressure wave time history recorded on the wave height meter for the necessary time calibration.

In Analysis II, the timing of the tsunami wave passing over the wave height meter after its correction by Analysis I and the estimated tsunami wave velocity were used to estimate the tsunami arrival timing when the tsunami reached the southern breakwater flexion.

There is a photo of the tsunami second wave (first peak) arriving at the southern breakwater flexion. The times of the continuous photos recorded have been corrected by comparing the time recorded on the camera and the estimated tsunami arrival time to the southern breakwater flexion obtained above.

In Analysis III, the tsunami arrival time was estimated based on the recorded plant data (times when the seawater pumps, power panels and diesel generators lost their functions).

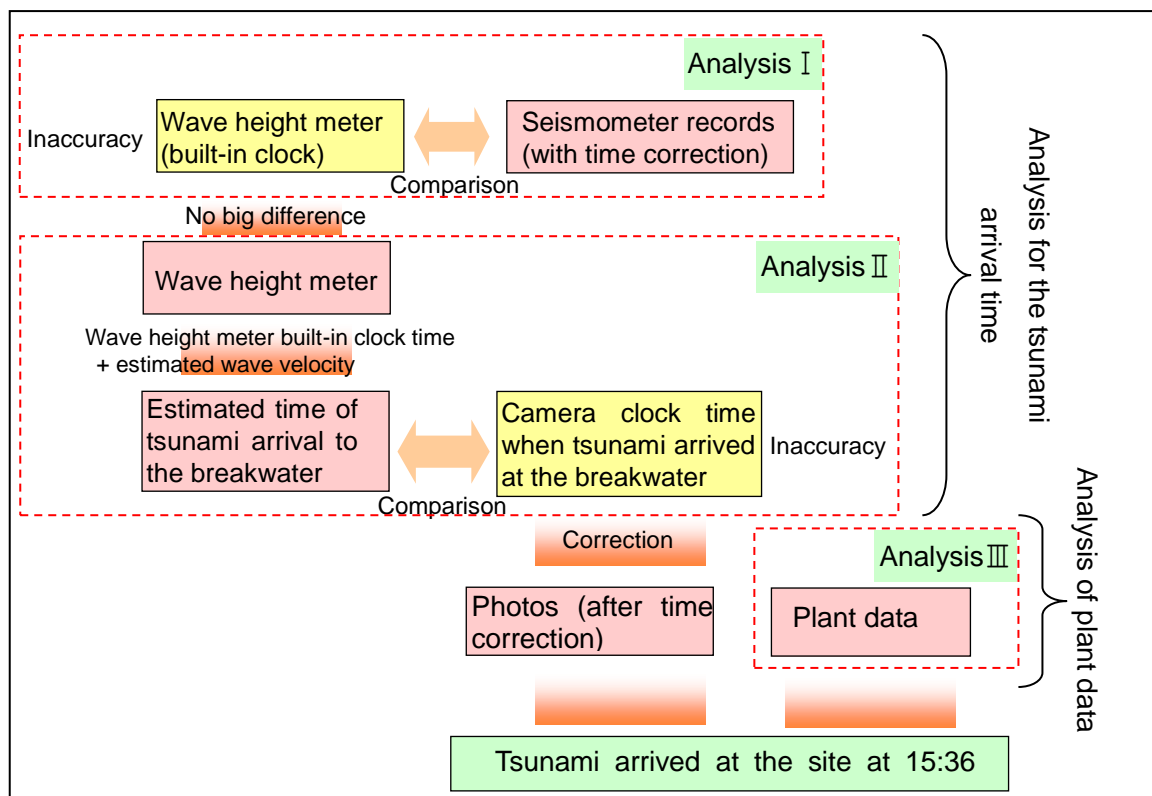

Figure Approach for the analyses of the tsunami arrival times at the site

4. Analysis using wave height meter records and photos

4.1. Purpose

The purpose was to analyze the time when the tsunami hit the site, using the tsunami wave time history recorded on the wave height meter located 1.3 km off the Fukushima Daiichi Nuclear Power Station site and the continuous photos taken on land.

4.2 Analysis of time data recorded on the wave height meter built-in clock (Analysis I)

Timing accuracy has been verified by comparing the slight initial motion recorded on the seismometers of each unit and the water pressure wave (responding to the seismic ground motion) recorded on the wave height meter.

Fluctuation noticed in the graph generated by the wave height meter can be considered to be due to the seismic motions, that is, the time when the seismic motion reached the wave height meter can be regarded as around 14:46:54 to 14:47:00 according to the wave height meter built-in clock.

On the other hand, the seismometers installed on each unit (their built-in clocks were calibrated on the hour) recorded that the seismic ground motion started at 14:48:48 to 14:48:52. As the seismic wave propagation speed is regarded as several kilometers per second or more, the time needed for propagation over 1.3 km is almost negligible, which was the distance separating the wave height meter and the seismometers at the power plant.

From deliberations above, the wave height meter built-in clock seemed to be about 4 to 10 s fast, when compared with the median value of the seismometers records of 14:46:50 as the seismic motion starting time. Thus, wave height meter timing would be considered to have no big discrepancy.

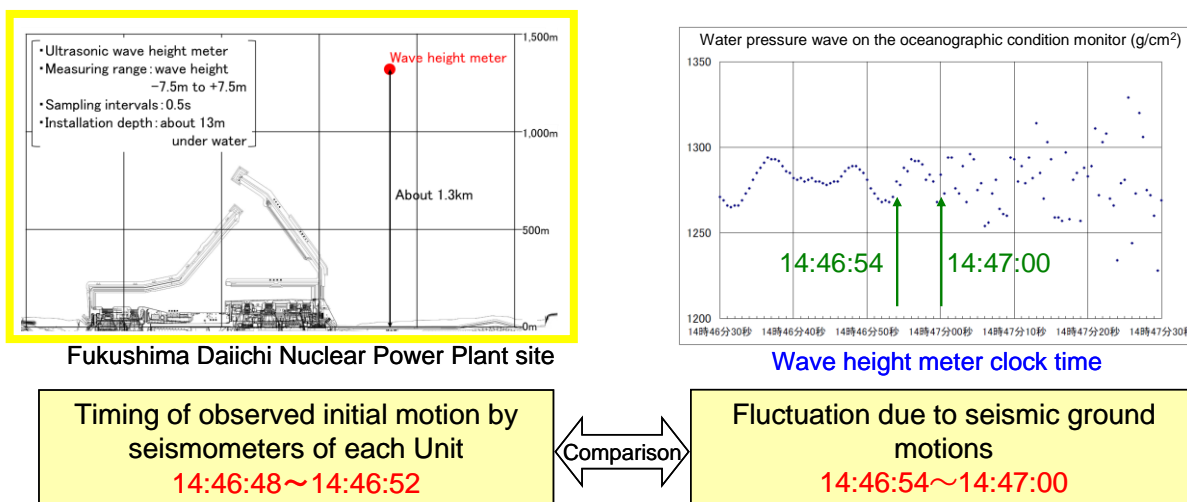

Figure Comparison between timing of observed motion by seismometers and fluctuation on wave height meter measurement

4.3 Analysis of photos (Analysis II)

(1) Continuous photo-taking

There were 44 continuous photos for Analysis II. The first 1st to 27th shots were taken from the northern side window of the main control room (hereinafter referred to as the "MCR") of the central radioactive waste treatment building. When viewed from the MCR window, the wall on the right side and the Unit-4 turbine building block part of visibility as shown in the attached figure: most of the southern breakwater is visible, but only the tip of the northern breakwater and only the portion from the Unit-2 reactor building to the south of the eastern seawall bank are in the view.)

The property information of each photo specifies timing of each shot as recorded by the camera built-in clock. In the following descriptions of (2) to (6), relative time difference (in minutes:seconds) from the first shot was used to specify the timing of each shot taken.

Relative locations of each shot are shown in [Appendix 1] and all 44 shots are arranged in [Appendix 2].

(2) Gradual dropping of sea level

The sea level conditions on the southern breakwater shows a gradual sea level drop over the time span of 1 min 26 s from Shot 1 to Shot 4. The sea level clearly declines over the following 3 min 34 s from Shot 4 to Shot 5.

Excluding Shot 1, the sea level in the bay seemed to be declining gradually at least from Shot 2 to Shot 5 (4 min 26 s or longer).

1 (00:00)

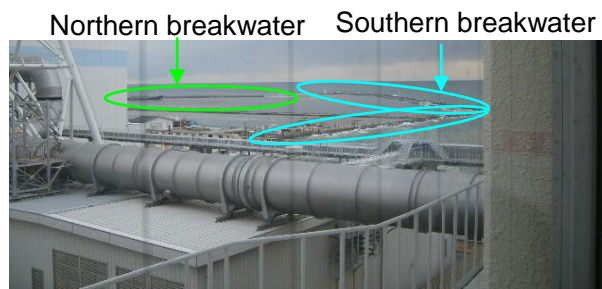

2 (00:34)

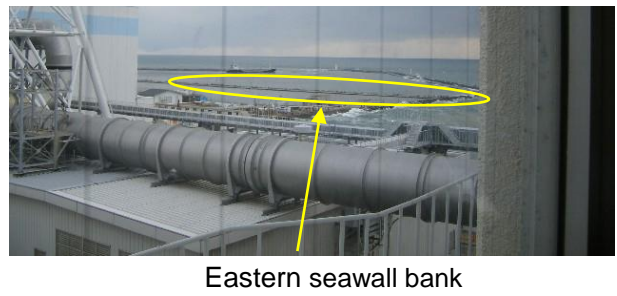

3 (01:02)



4 (01:26)



5 (05:00)



(3) Clear recognition of bores

Shot 7 clearly shows the approach of the bore-type tsunami. At this moment the bore had not yet reached the main part of the southern breakwater and the lighthouse on its tip; the bore was clearly outside the bay. Judging from the positions of the bore and a ship in the photo, Shot 7 was taken immediately after the ship had passed the bore.

In Shot 8, the bore reached the southern breakwater and the lighthouse on its tip was behind the tsunami, so that at this moment the bore had reached the flexion of the southern breakwater.

When having a look at portions that were not flooded on the land side base of the southern breakwater and the eastern seawall bank, Shot 5 and Shots 6 to 8 have similar conditions of not being flooded. Therefore, it may be understood that the tsunami bore, on the order of several meters in height as seen in Shots 7 and 8, reached that point immediately after the gradual drop of the sea level.

In other words, it can be judged that water drop in Shots 1 to 5 was after the peak of the first wave, and the bore in Shots 7 and 8 was the second wave (first step).

There were four shots, 5 to 8, during 1 min 20 s. Then it was judged that these shots could catch the arrival of second wave (first step) and there was nothing more missing.

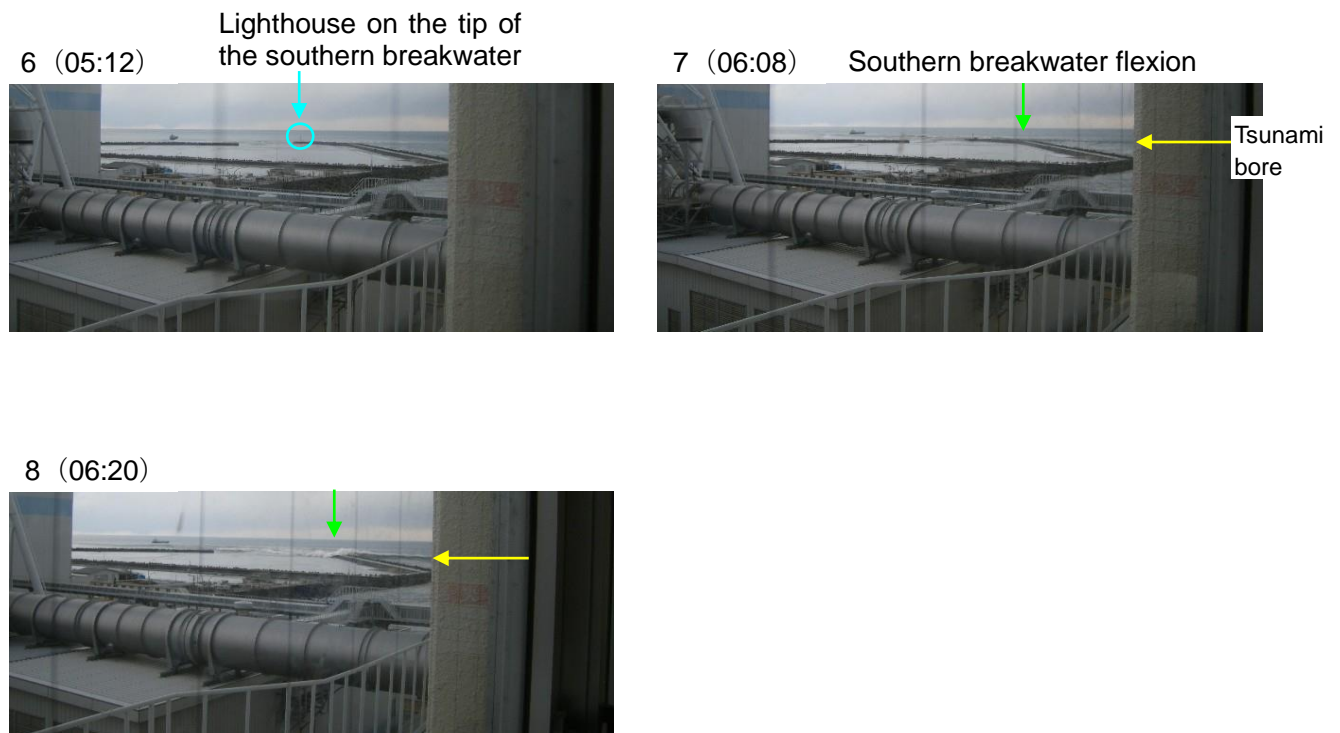

(4) Water column due to tsunami

Shots 9 to 12 show tsunami bore running along the southern breakwater, i.e., the tsunami second wave (first step).

In Shot 11 the base area of the southern breakwater is covered by the tsunami water, while the bore cannot be confirmed to have reached the eastern seawall bank. Therefore, the brown water column seen is due to the tsunami which did not come from bay area (from east) but from southeast into the front side of Unit4. But it cannot be judged from this shot only whether it resulted when the tsunami collided with some structures after running up to the 4-m ground level above O.P. (O.P. : Onahama Port construction standard surface, hereafter described as 4-m ground level) or it ran through a water discharge canal and rose from its opening. The location can be considered to be around the border between the 4-m ground level and 10-m ground level, because the column appeared immediately northeast of a hut on the 10-m ground level in front of the Unit-4 building.

In Shots 11 and 12, a wave, probably the second wave (second step), can be seen off the coast. The water column in Shot 11, therefore, can be considered to have risen when the second wave (first step) in the order of several meters in height as observed in Shots 6 to 8 reached the area near the border between the 4-m ground level and 10-m ground level.

The time difference between Shot 8, showing the arrival of the tsunami second wave (first step), and Shot 12 is 48 s, and it can be considered that no phenomenon has been overlooked and consequently the water column was generated due to the second wave (first step).

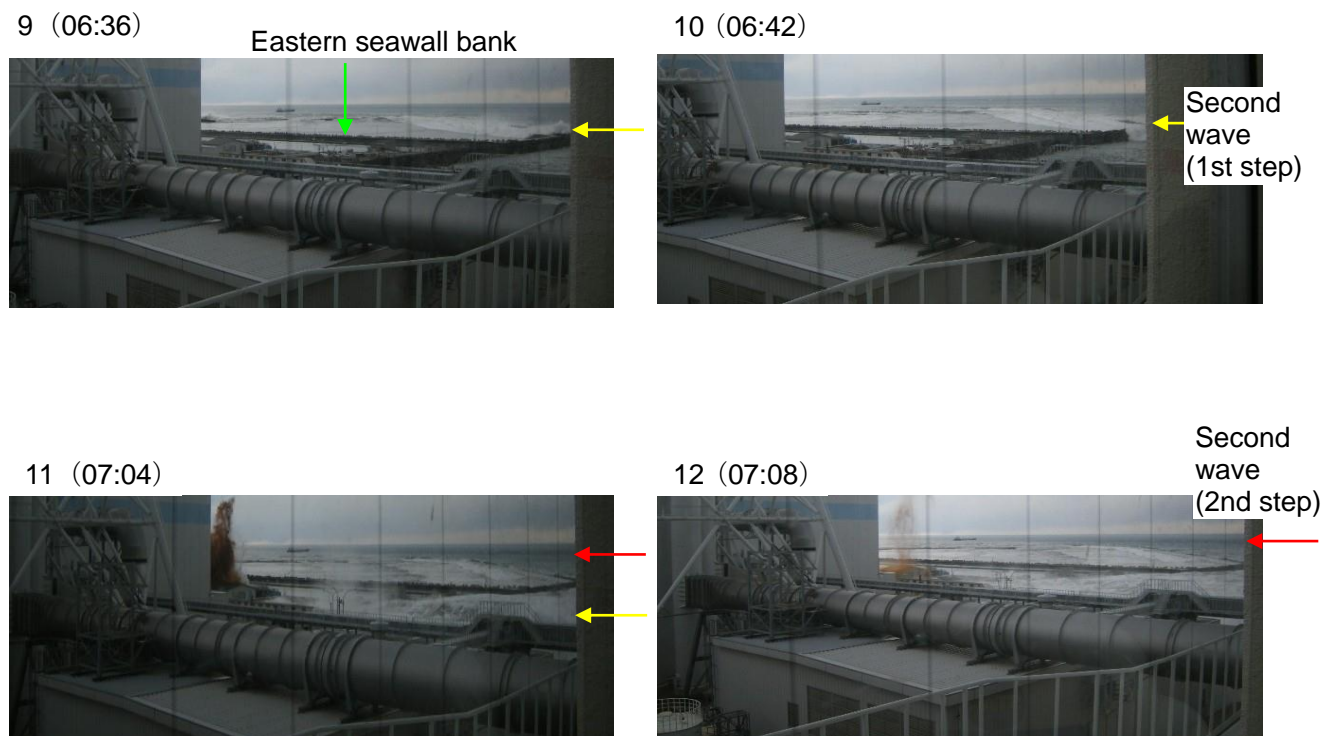

(5) The arrival of the highest wave (second wave (second step)) in the bay

Shot 13, 20 s after Shot 11 with the water column, shows inundation to the 10-m ground level.

On the upper right of Shot 14, 6 s after Shot 13, a structure, probably the eastern seawall bank, can be recognized (A). This timing will be around the time when the second wave (first step) in the order of several meters height as recognized in Shots 7 and 8 reached the 10-m ground level. In Shots 15 and 16, the base of the stack is seen (B), and no big tsunami run-up like those in Shots 17 and 18 is visible. Based on these observations, it can be understood that in Shots 13 to 16 the second wave (second step) in the order of 10 meters high had not reached the 10-m ground level yet and that the run-up to the 10-m ground level recognized in Shots 13 and 14 by the second wave (first step) was a limited scale.

In Shot 15, 12 s after Shot 14, tsunami water covers the southern and northern breakwaters. In Shot 16, taken 14 s after Shot 15, the eastern seawall bank is also covered by the tsunami water in addition to the southern and northern breakwaters and big bores are recognized in the bay.

13 (07:24)



14 (07:30)

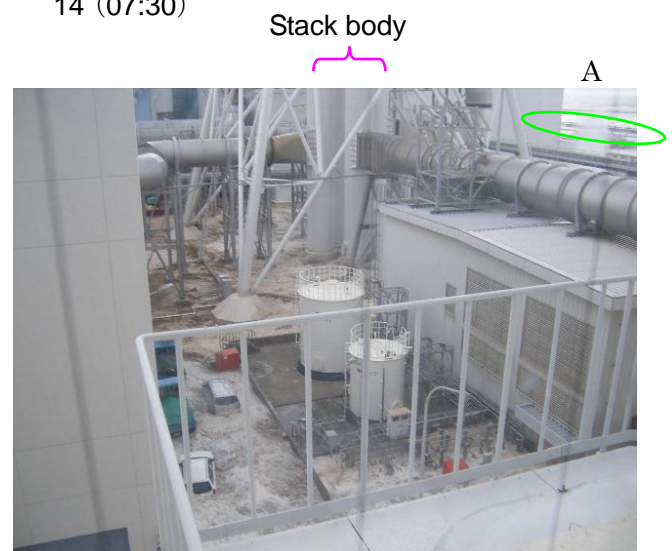

15 (07:42)



16 (07:56)

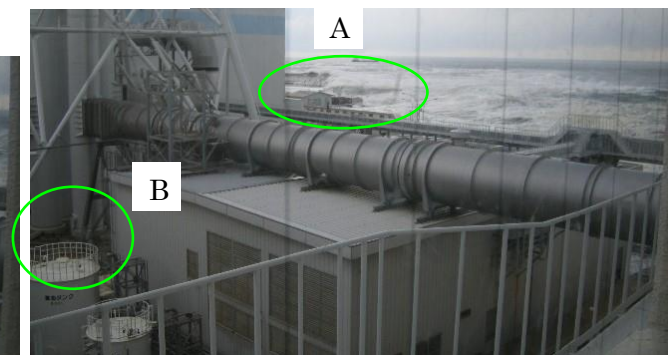

(6) The arrival of the highest wave (second wave (second step)) at the 10-m ground level

In Shot 17, taken 14s after Shot 16, a large amount of seawater flows over the 10-m elevation level and continues in the scenes of Shots 18 and 19. The scene inside the bay is not clear in Shot 17. In Shots 18 and 19, the elevated sea surface can be confirmed, but breakwaters and seawall bank cannot be recognized. This means that, besides the second wave (first step), there was another wave that was big enough to flood completely the breakwaters and seawall bank.

Shot 18 was taken 24 s after Shot 16 which shows a massive tsunami rushed into the bay. Further, in Shots 18 and 19, the electrical room on the 10-m ground level is almost completely flooded; which had been seen in Shots 15 and 16. As this electrical room was 5.15 m high, tsunami in Shots 18 and 19 can be regarded as about O.P. +15 m.

From these examinations, it can be concluded that at around the time Shot 18 was taken the second wave (second step) of about O.P. +15 m high had reached the areas near all reactor buildings of the Fukushima Daiichi Nuclear Power Station site.

The time history chart of the tsunami level on the wall of a light oil tank and the electrical room in these shots indicates that the run-up of the tsunami in Shots 13 to 16 was a limited scale and the run-up became large scale from just before Shot 17. This observation agrees with the results of the photo analysis.

17 (08:10)



18 (08:20)



19 (08:38)



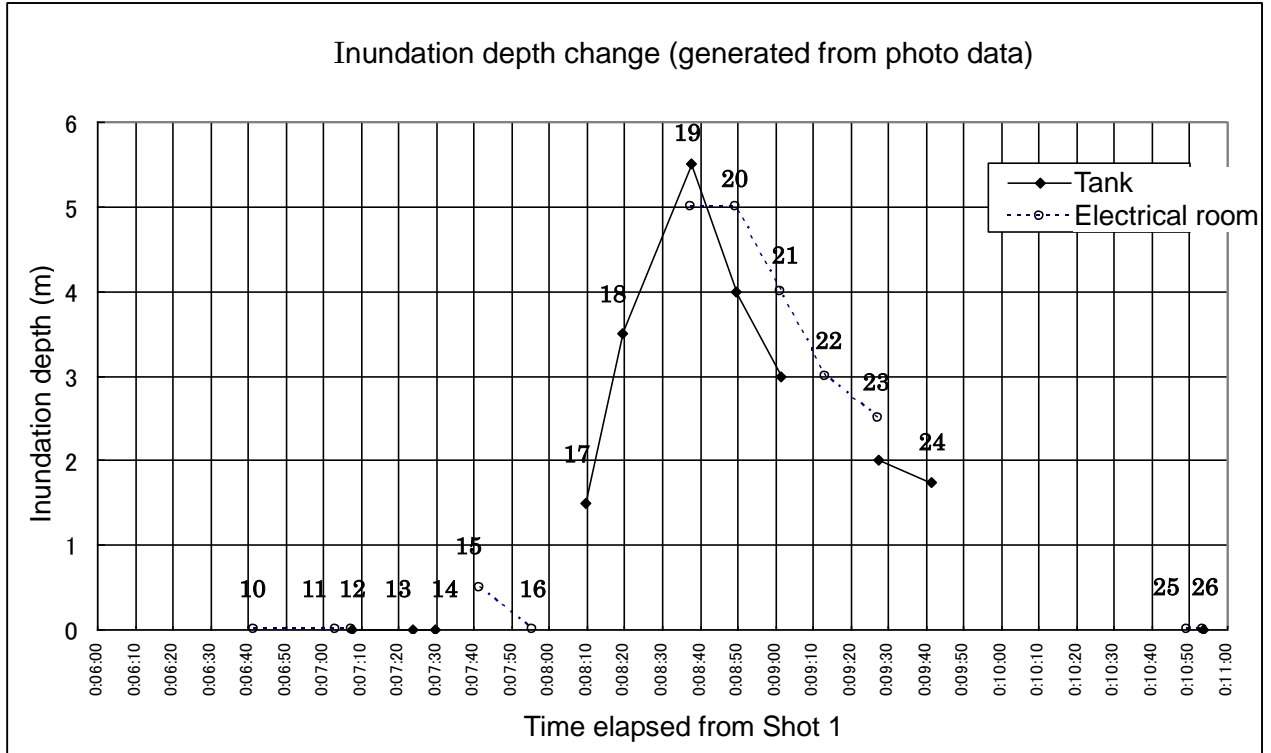

4.4. Estimation of propagation time of tsunami waves from the wave height meter location to the southern breakwater flexion and correction of times when photo were taken

As mentioned before, the bore of the second wave (first step) reached the southern breakwater flexion in Shot 8, which allows correction of the time when the shot was taken. The procedure is:

- (a) Identification of the distance from the wave height meter to the southern breakwater flexion;
- (b) Calculation of time needed for the second wave (first step) propagation from the wave height meter to the southern breakwater flexion; and
- (c) Identification of the time of Shot 8 taken by adding time (b) above to the time of the second wave (first step) arrival at the wave height meter.

(a) Distance from the wave height meter to the southern breakwater flexion

The distance from the wave height meter to the tip of the southern breakwater was about 900m.

This distance was set slightly longer, i.e., there was a slightly longer time for propagation in this estimation. This is further explained in [Appendix 3].

(b) Time needed for the second wave (first step) propagation from the wave height meter to the southern breakwater flexion

The sea depth where the wave height meter was installed was about 13m, while that of the flexion was about 6m.

By the use of an approximation formula: $c = (gh)^{1/2}$ for tsunami propagation velocity and Green's Rule, $H_2/H_1 = (h_1/h_2)^{1/4}$, for tsunami height, time required for propagation from the wave height meter location to the bay area can be estimated as follows. Details are in [Appendix 4].

a. Propagation time calculated from the estimated velocity based on the still water depth

To get a slight overestimation, the propagation time was estimated using the still water depth. As a result, the propagation time of about 95 s was obtained from the wave height meter to the southern breakwater flexion.

b. Propagation time calculated from the estimated velocity based on the total water depth

To get a more realistic estimation, the propagation time was estimated using the total water depth (= still water depth + tsunami wave amplitude). The wave amplitude was set as 4.5 m, which is the average value of the second wave (first step) recorded on the wave height meter. As a result, the propagation time of about 76 s was obtained from the wave height meter to the southern breakwater flexion.

Based on the above, the propagation time from the wave height meter to the bay area is estimated as 76 - 95 s.

(c) Identification of the time Shot 8 was taken

The time when the second wave (first step) reached the wave height meter was about 15:33:30. When the estimated time for propagation is added to this, the time when Shot 8 was taken is estimated to be between 15:34:46 and 15:35:05. On the other hand, the time recorded on the camera built-in clock was 15:41:36.

From the above, the camera built-in clock is estimated to be fast by 6 min 31 s to 6 min 50 s. From considerations (b)-a and (b)-b above, it is expected that 6 min 50 s is closer to reality.

4.5 Summary (Analyses I and II)

The following results have been obtained by examining the wave height meter records and photos in detail.

- (a) The camera built-in clock was 6 min 31 s to 6 min 50 s fast. The real difference is likely to be close to 6 min 50 s.
- (b) When the mean value of (a) (6 min 40 s) was used for correction, Shot 1, taken at 15:35:16 by the camera clock, was actually taken at about 15:28:36.
- (c) With the same correction, it was at about 15:34:56, when the second wave (first step) reached the southern breakwater flexion (Shot 8), at about 15:36:00 when small scale inundation could be confirmed to have started around the tanks on the 10-m ground level (Shot 13).
- (d) It was from about 15:36:18 to about 15:36:32 when the run-up to the tank area on the 10-m ground level stopped once (Shots 15 and 16).
- (e) Further it was at about 15:36:46 when the large scale inundation could be confirmed to have started around the tanks on the 10-m ground level (Shot 17), and at about 15:37:14 when the tanks disappeared completely under water (Shot 19).
- (f) The following figure shows the inundation situations of the tanks, etc. with the same time correction.
- (g) Run-up of the second wave (first step) to the 10-m ground level remained as a limited one, but it can be understood that the second wave (second step) ran up to the 10-m ground level and almost completely covered the breakwaters and seawall bank.

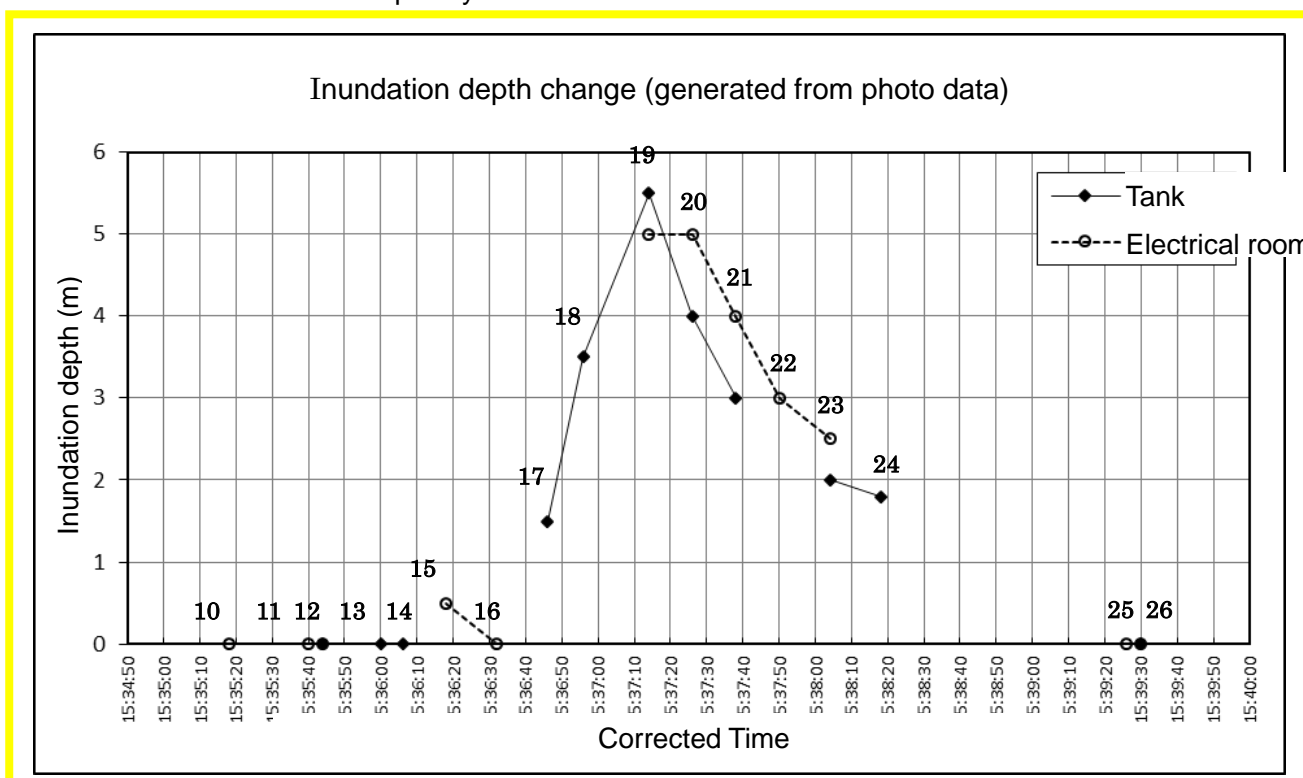

5. Analysis by the use of plant data (Analysis III)

5.1 Purpose

Among plant data (stored in the process computers, transient recorders, etc.) the following information was included which indicated the abnormal conditions such as flooding.

- Shutdown times of seawater pumps (circuit breakers worked when motors were flooded, etc.)
- Diesel generator (DG) operation records (voltage, current)
- Data recordings by emergency power panels

Among such information above, the seawater pumps would be the first to be affected by the tsunami, because they were located closest to the sea. The information recorded on the power panels or D/Gs installed in the main buildings can also be used as supplementary information for analyzing the exact arrival time of the tsunami to the Fukushima Daiichi Nuclear Power Station site.

5.2 Analysis of plant data

Plant data were first screened from the following criteria for appropriate utilization

- Clock calibration function is installed
- Electronic data useful to analysis were recorded
- Data at around the times of tsunami arrivals were recorded

The situation is summarized in the following table.

	Unit-1	Unit-2	Unit-3	Unit-4	Unit-5	Unit-6
Process computers (with electronic data storage)	Not available	Yes available	Not available	Not available, as the system being replaced during the periodic inspection	Yes available	Not available
Transient recorders (Data recorded at around the tsunami arrivals)	Yes available	Yes available	Not available		Not available	Not available

Process computers which have electronic data storage were only installed in Unit-2 and Unit-5, and it is possible to make time corrections for both. Concerning the transient recorders, the data of Unit -1 and Unit-2 are available and time correction is also possible (there was only a data sampled in one minute cycle for Unit-1). In Unit-3, some data from around 14:59:43 on March 11th were not stored and therefore the unit was excluded from the analysis. In Unit-4, the transient recorder was being replaced during the periodic inspections and no data were stored. The transient recorder in Unit-5 had no data when the tsunami arrived and was excluded from the analysis. Unit-6 was under periodic inspection and so the recording system was not in service.

From the reasons above, one minute cycle data of the transient recorder of Unit-1, and the

process computer data of Unit-2 and Unit-5 were used in the analysis.

[Shutdown time of seawater pumps]

- ✓ Containment cooling sea water system (CCSW) pumps of Unit-1

The CCSW pumps (A) to (D) had anomalies between 15:35:59 and 15:36:59 and lost their functions, according to the one minute cycle data recorded on the transient recorder.

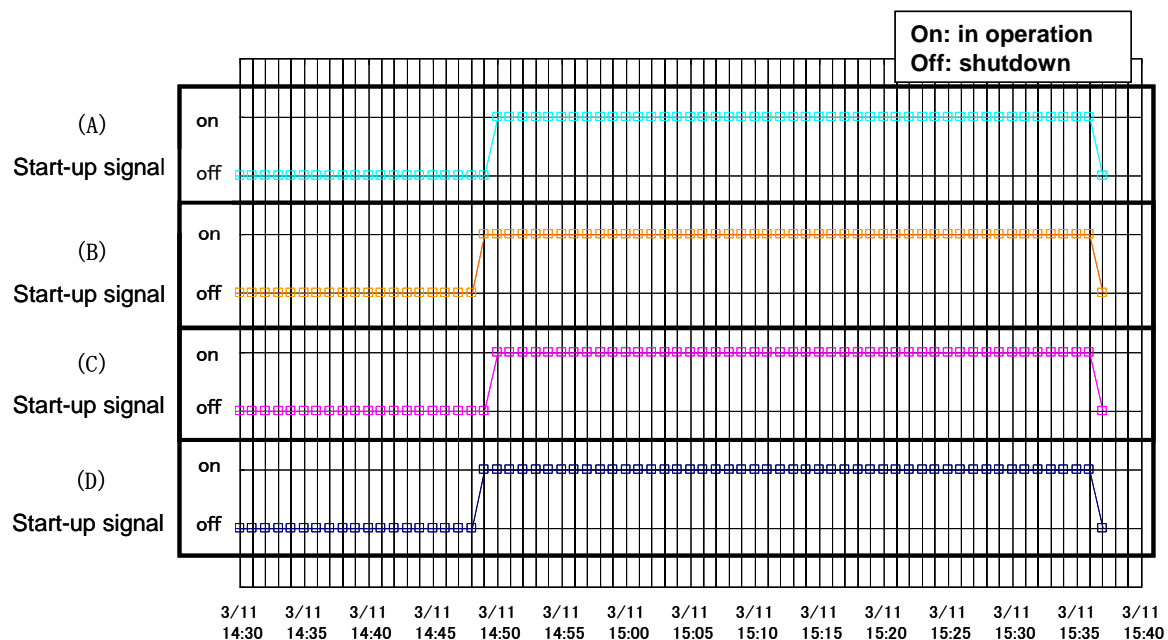

- ✓ Residual heat removal sea water system(RHSW) pumps of Unit-2

The circuit breakers of RHSW pumps (A) and (C) were opened and lost their operating functions at 15:36:58, according to the records in the process computer.

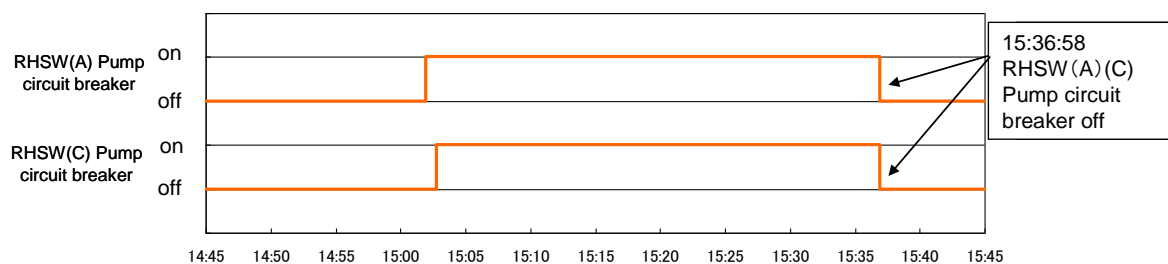

- ✓ Residual heat removal sea water system (RHRS) pumps of Unit-5

The RHRS pumps (B) and (D), which had started operation after the earthquake, had anomalies and lost operating functions at 15:37:09 and 15:37:10 according to the records in the process computer.

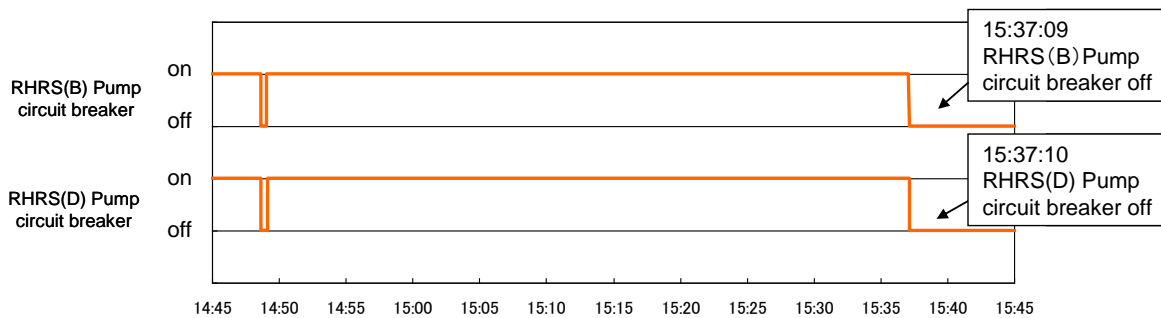

[D/G operation records (voltage, current)]

✓ D/Gs (1A) and (1B) of Unit-1

The voltage of the D/Gs (1A) (1B) of Unit-1 had been established until 15:36:59 while the transient recorder was recording data. This confirms their function losses were sometime after 15:36:59.

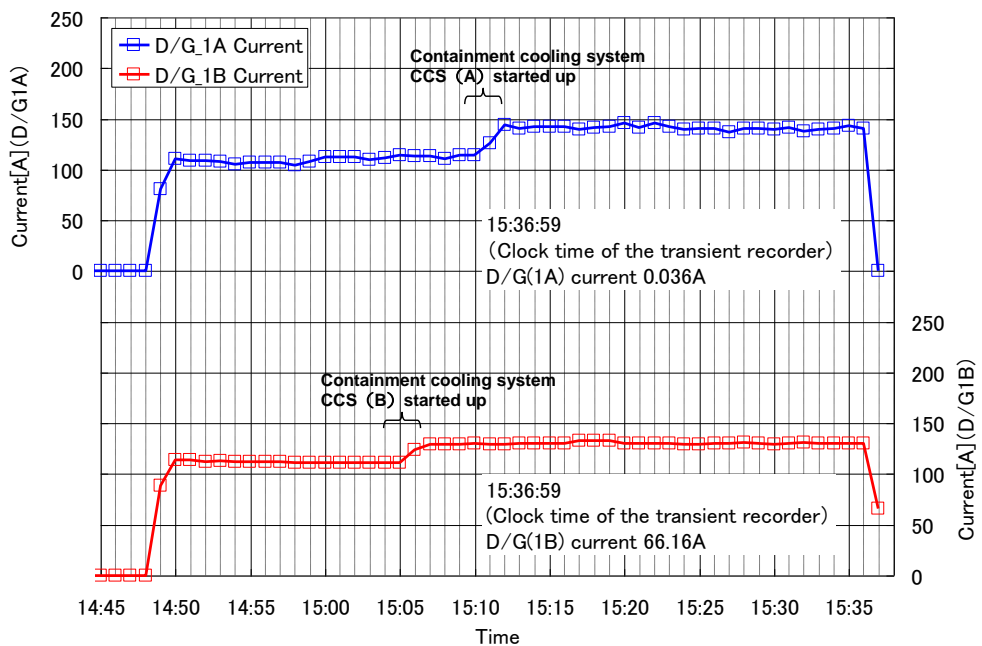
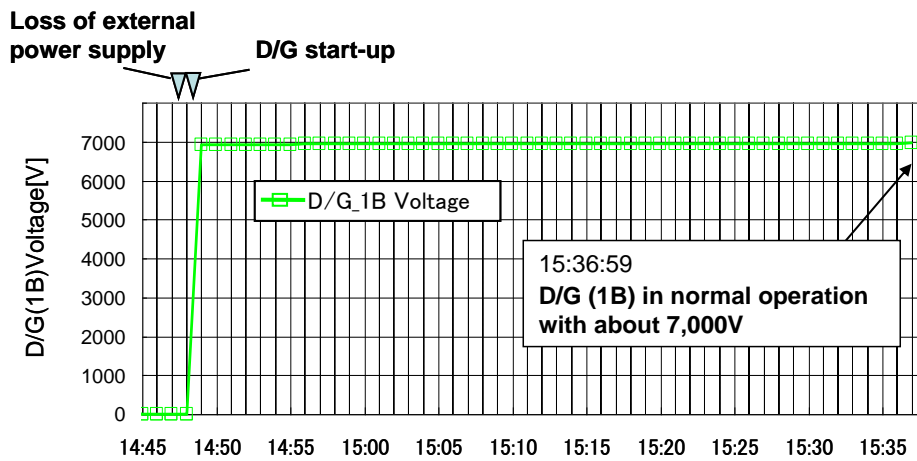
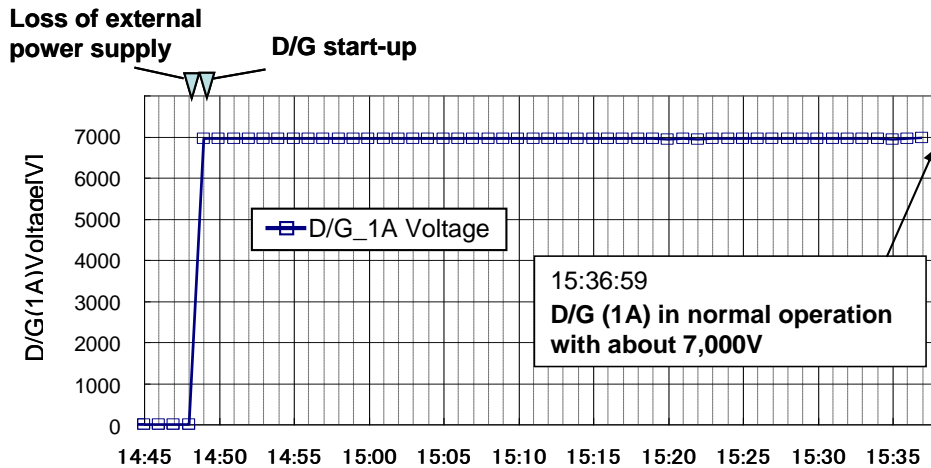

✓ D/Gs (2A) and (2B) of Unit-2

The power receiving circuit breaker of D/G (2A) opened at 15:37:40, according to the data recorded on the process computer.

The D/G (2A) was confirmed in a later investigation to have been flooded. The function loss is assumed to be due to flooding of the D/G body or its related facilities.

The D/G (2B) was installed in another building (the common pool building) and its body was not damaged. But its breaker opened at 15:40:38. The function is assumed to have been lost due to the effect of damage to its related facilities or flooding of the emergency power panels to which the D/G (2B) was supplying power.

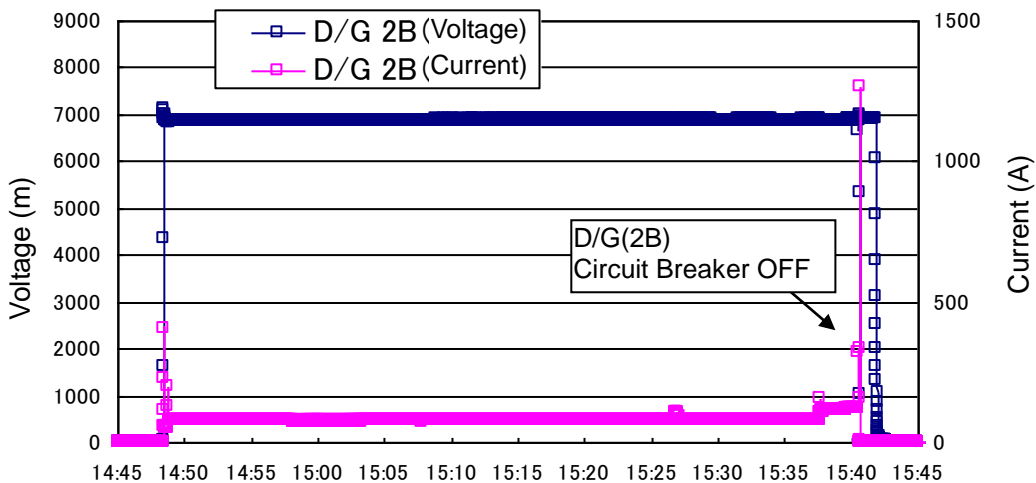
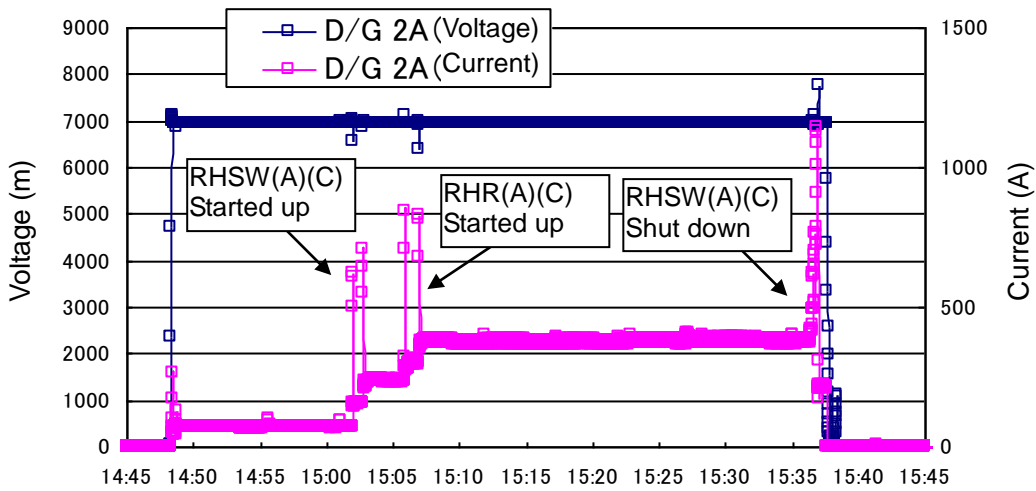
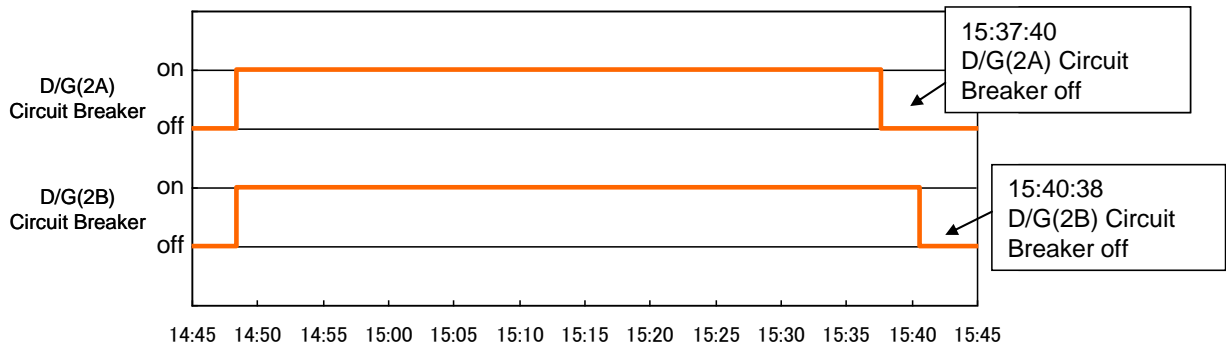

✓ D/Gs (5A) and (5B) of Unit-5

The D/Gs (5A) (5B) had anomalies at around 15:40 and lost their function, according to the data recorded on the process computer.

The bodies of D/Gs (5A) (5B) were confirmed in later investigation to have had no damage by flooding. The function is assumed to have been lost due to damage of their related facilities or flooding of the emergency power panels.

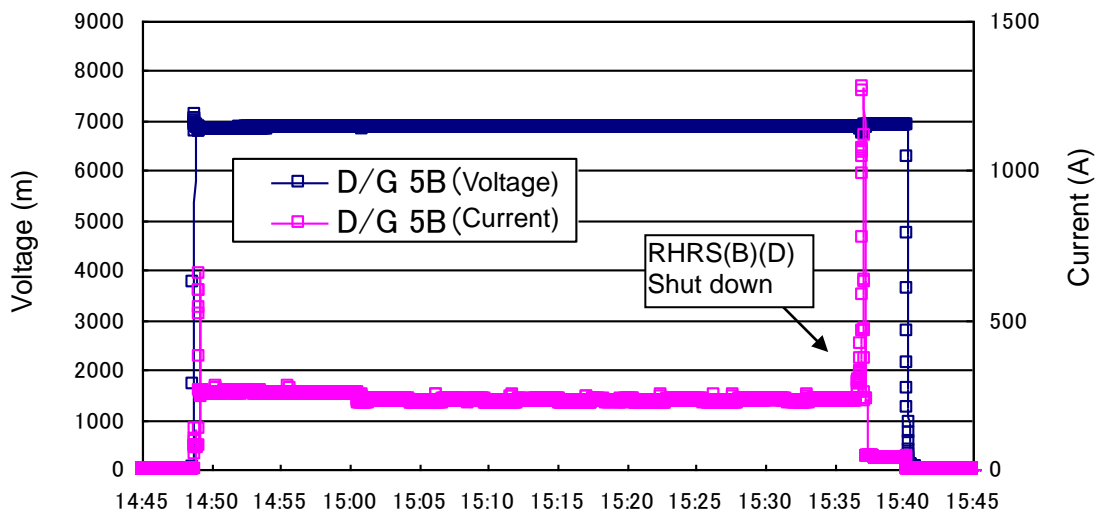
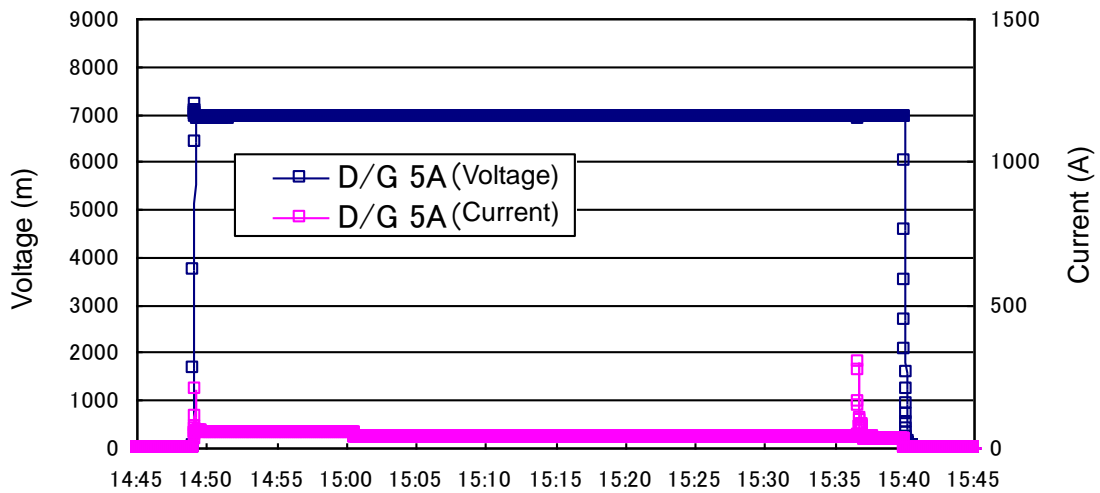
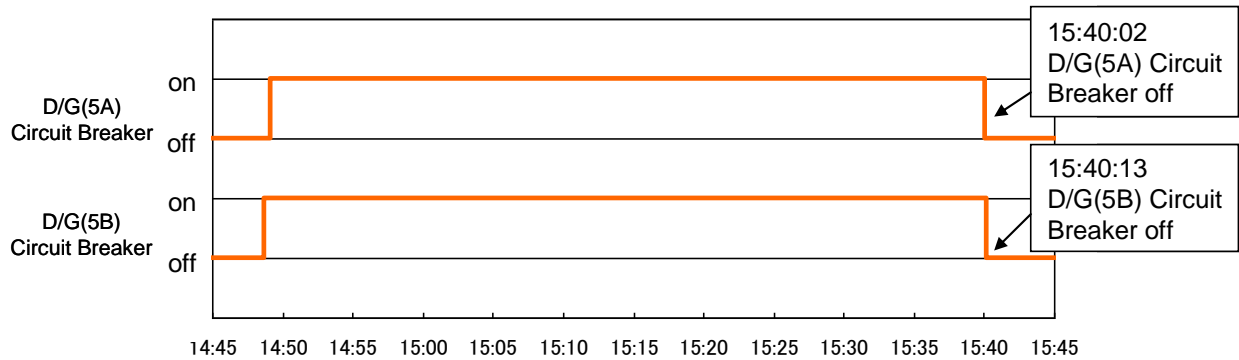

[Emergency power panels]

✓ Emergency power panels 1C and 1D of Unit-1

The emergency power panel 1C lost the emergency bus voltage between 15:35:59 and 15:36:59, while the emergency bus voltage of the emergency power panel 1D has been established until 15:36:59, according to the one minute cycle data recorded on the transient recorder. This confirms the function losses of the emergency power panel 1D was sometime after 15:36:59.

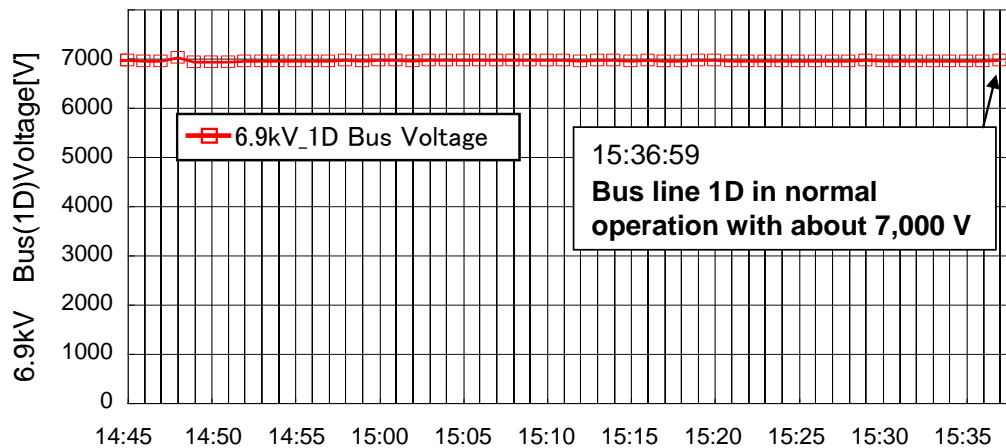
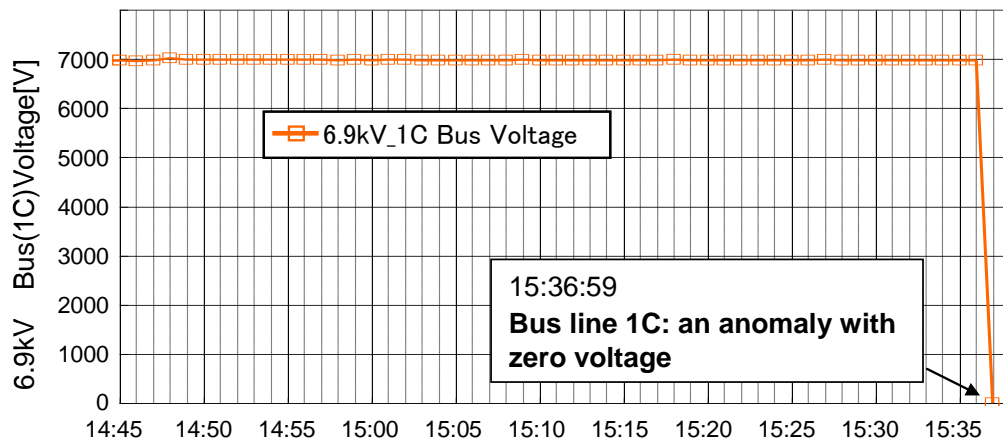

✓ Emergency power panels 2C and 2D of Unit-2

The emergency power panel 2C lost the emergency bus voltage at 15:37:42, while the emergency power panel 2D lost it at 15:40:39, according to the data recorded on the process computer for emergency power panels.

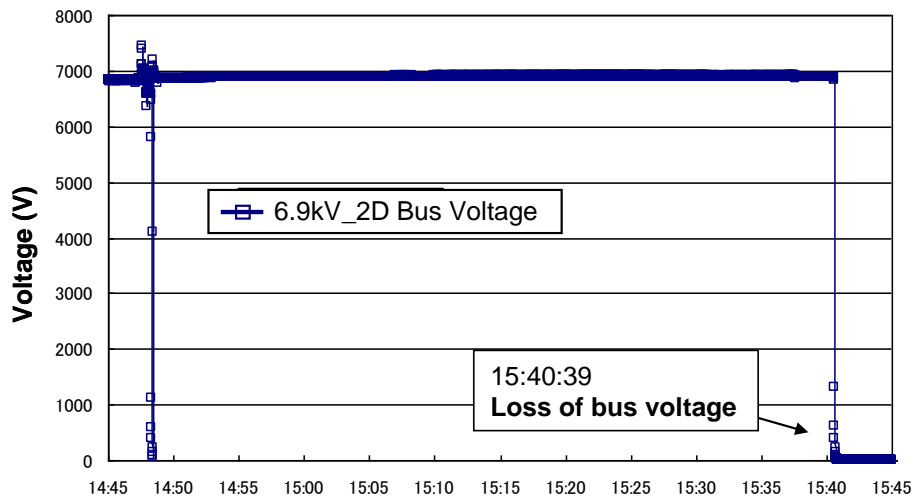
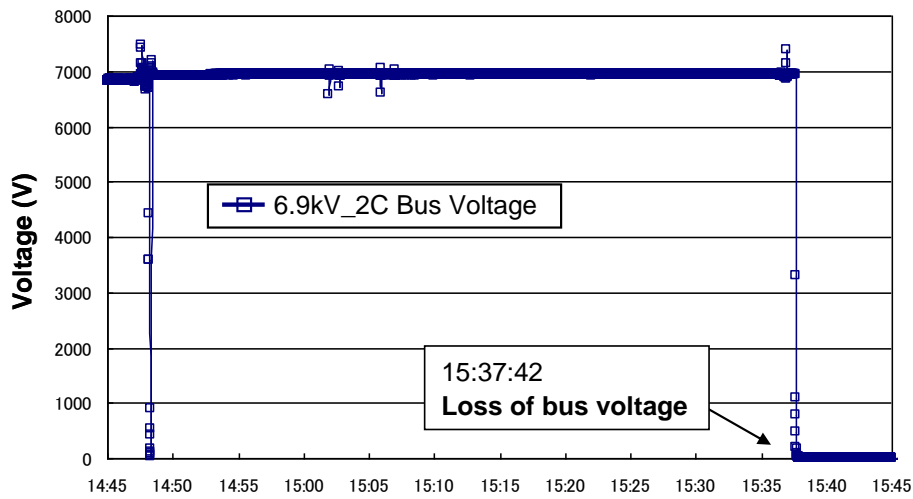
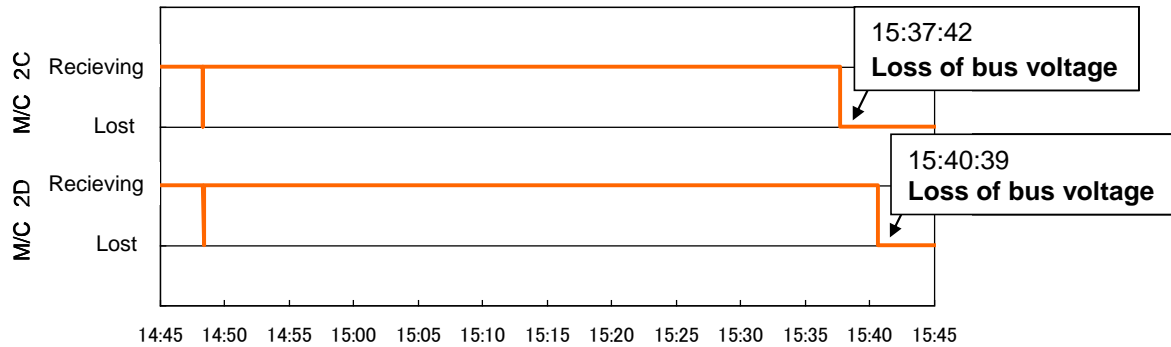

- ✓ Emergency power panels 5C and 5D of Unit-5

The emergency power panel 5C lost the emergency bus voltage at 15:40:03, while the emergency power panel 5D lost it at 15:40:15, according to the data recorded on the process computer.

The D/Gs showed no anomalies in a post-accident investigation. The loss of function is assumed to have been caused by that of the metal-clad switchgear (M/C) or D/G related facilities, which were flooded.

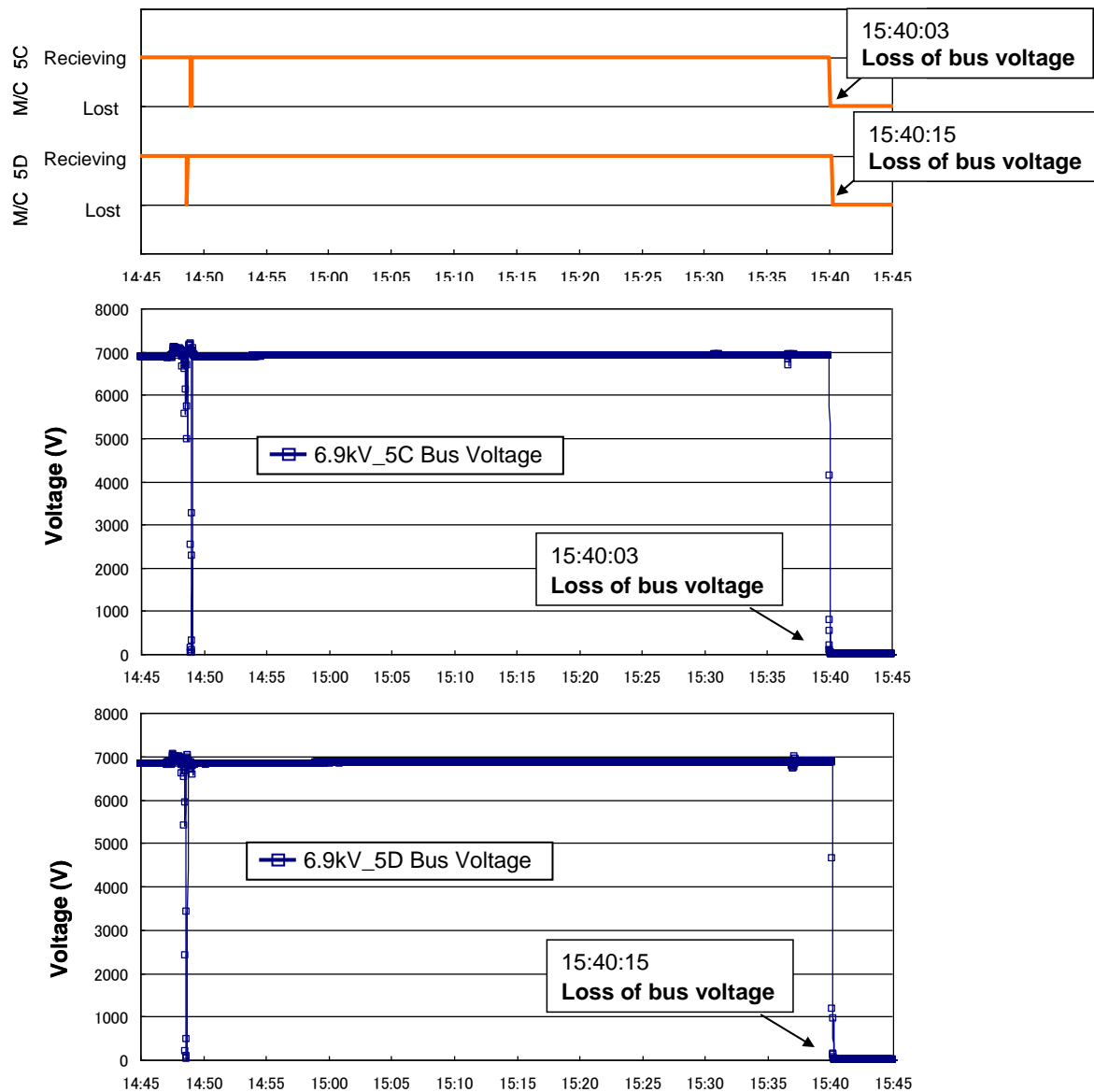

5.3. Summary of analysis by the use of plant data (Analysis III)

Seawater pumps closest to the sea (installed on the 4-m ground level) lost their function mostly at the 15:36 level, which is thought to be due to the arrival of tsunami second wave at the site.

In other main buildings, the timing of function loss varied depending on the installed locations, but the emergency bus function was lost mostly at around 15:40 caused by tsunami, resulting in the loss of all AC power supplies.

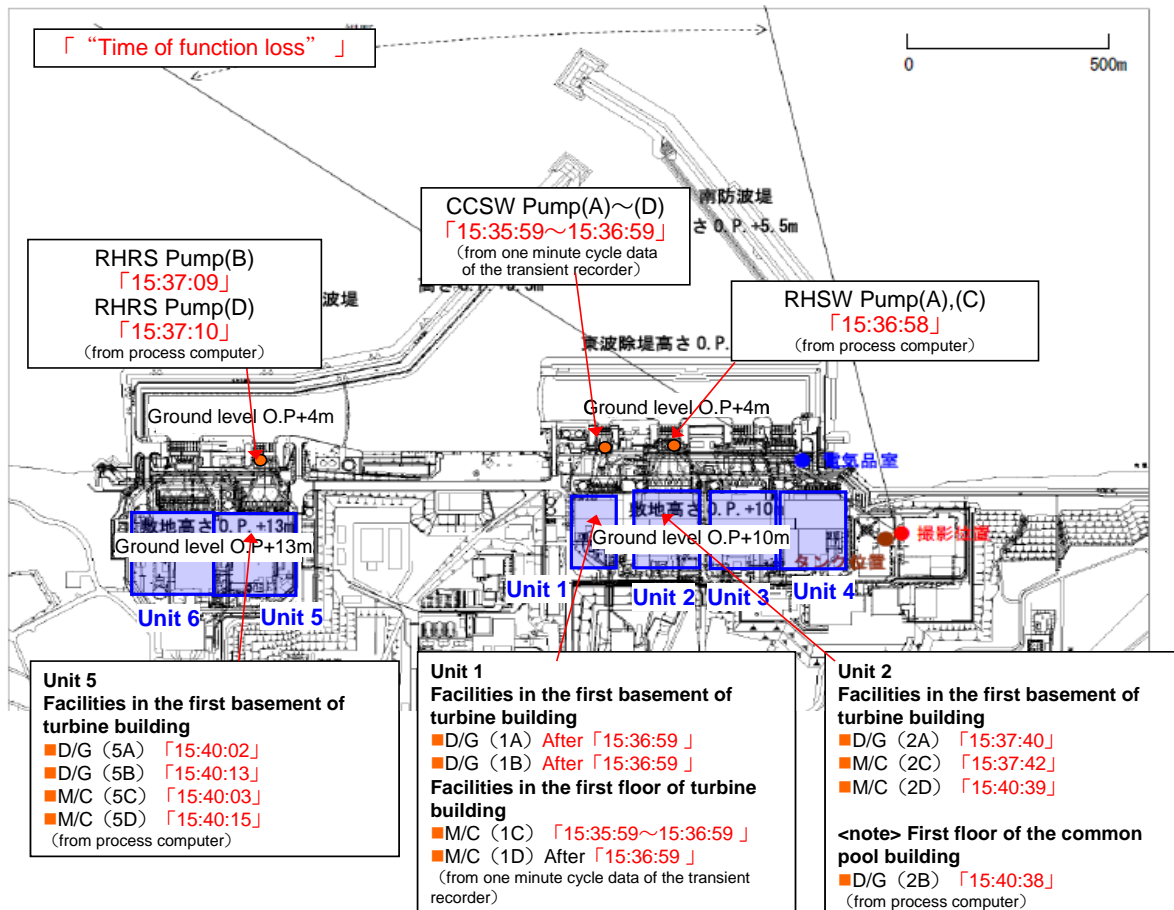

6. Conclusion

The results of Analyses I, II and III can be summarized as follows.

Analysis I showed no big timing errors in the wave height meter.

Analysis II showed the photo-taking timing by the camera had an error of about 6 min 40 s.

Timing correction of photos led to the following judgments.

- ✓ Around 15:36:00: small scale inundation could be confirmed around the tanks on the 10-m ground level due to the tsunami second wave (first step).
- ✓ Around 15:36:46: large scale inundation could be confirmed around the tanks on the 10-m ground level due to the tsunami second wave (second step).

Analysis III based on the plant data indicated that the tsunami second wave reached the site at 15:36 level. Furthermore seawater pumps closest to the sea lost their function mostly at the 15:36 level due to the arrival of tsunami second wave at the site. Then the emergency bus function was lost mostly at around 15:40 after the arrival of tsunami second wave at the site, resulting in the loss of all AC power supplies.

We believe from the above analysis (photo-taking timing and plant data) that the tsunami reached the Fukushima Daiichi Nuclear Power Station site at 15:36 level.

【Appendix 1】 Positional relation of continuous photos

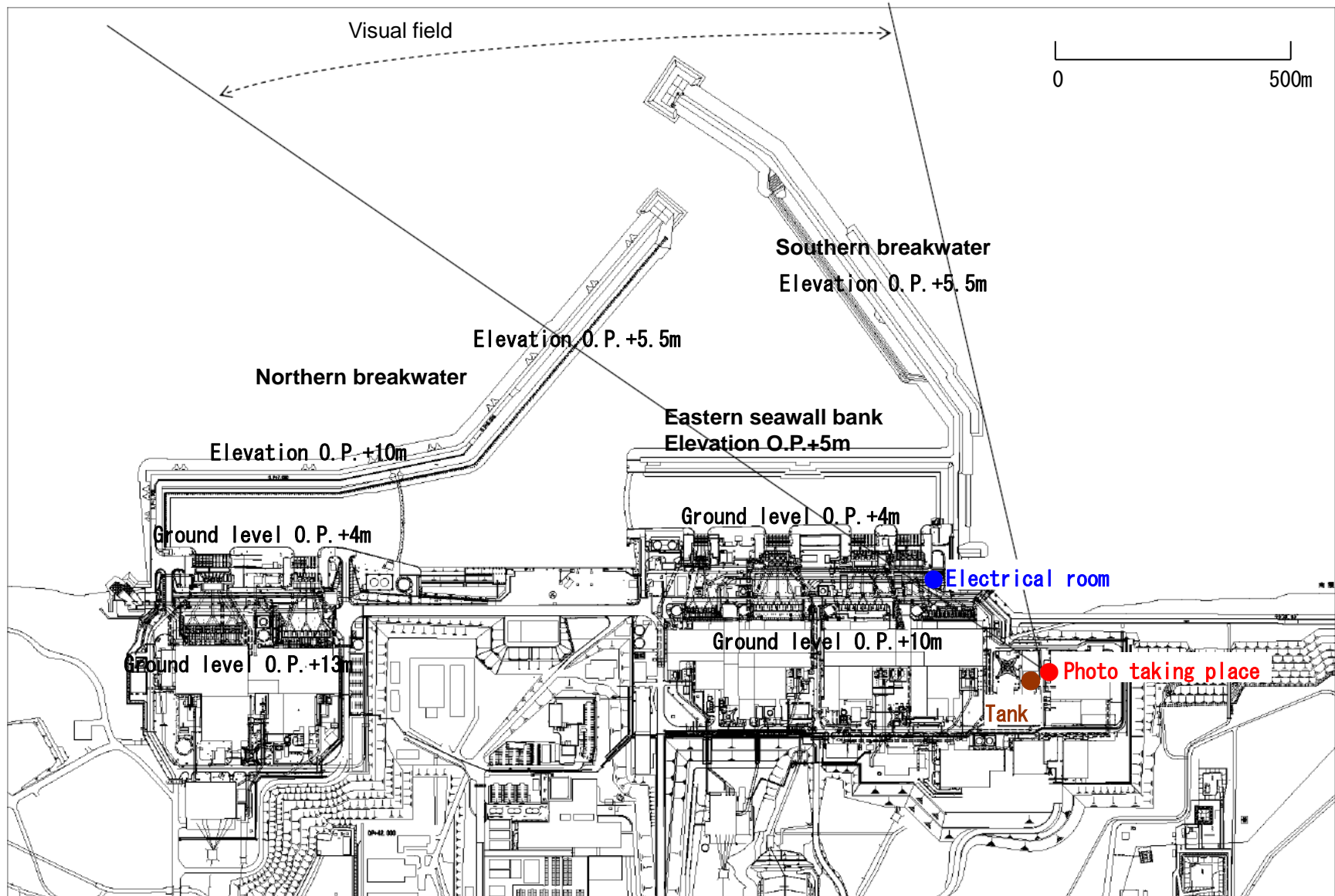

【Appendix 2】 All 44 continuous photos

Attachment Earthquake-tsunami -1-26

Time point of photos (after correction)

Camera built-in clock time was 6 min 31 s to 6 min 50 s fast.
 In the graph below, time points of photos are corrected for 6 min 40 s, the average value of the above
 (Example: Camera timing of 15:35:36 was corrected to 15:28:36.)

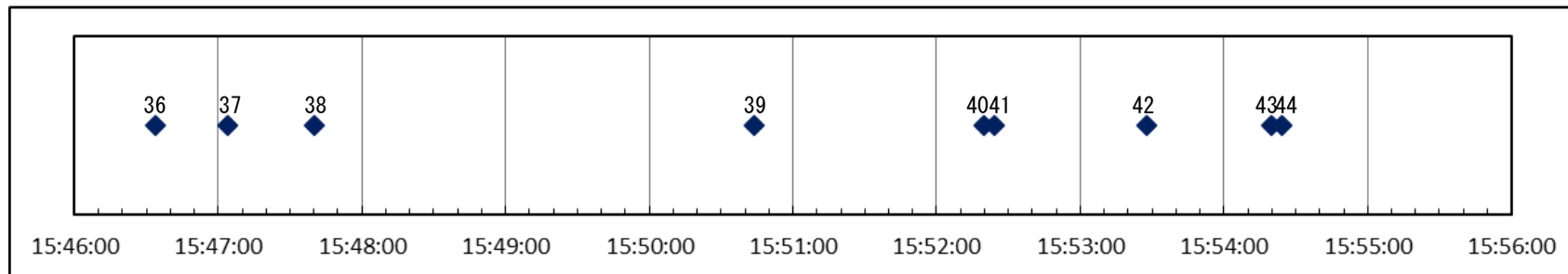
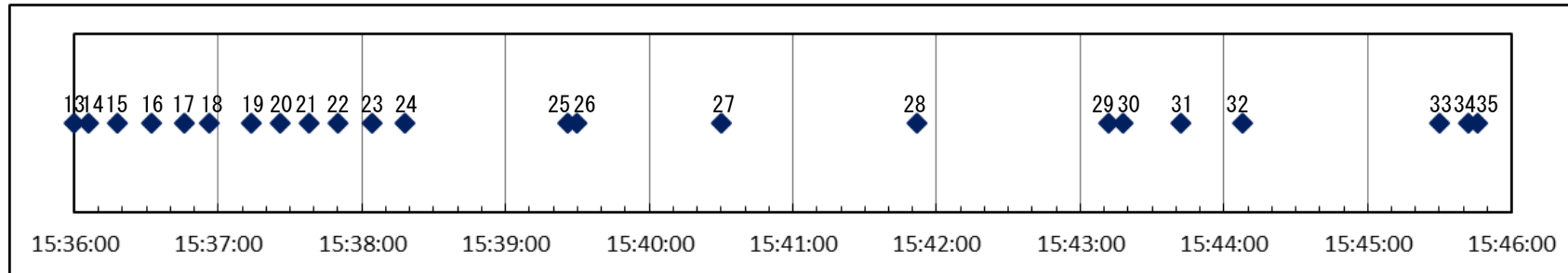
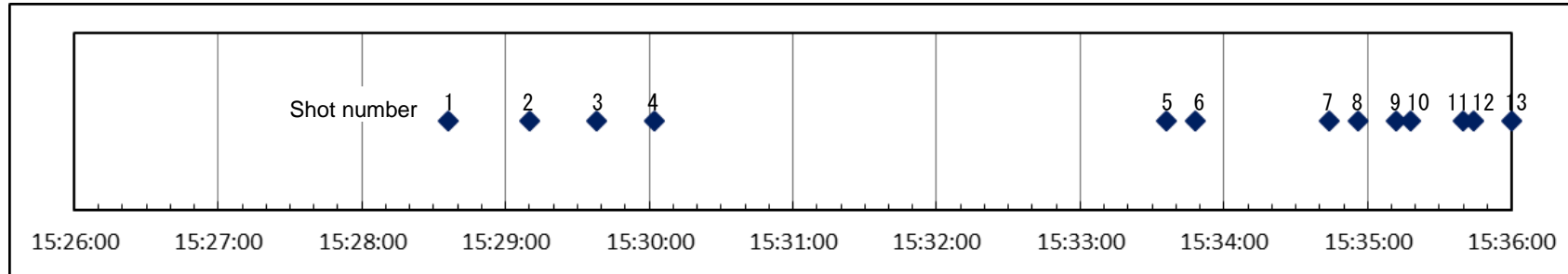

Legend upper left

Shot number (time elapsed from Shot 1)

Time after correction (corrected time)

Time before correction (camera built-in clock time)

1 (00min.00 sec. later)

about 15:28:36 (corrected time)

15:35:16 (camera built-in clock time)



2 (00min.34 sec. later)

about 15:29:10 (corrected time)

15:35:50 (camera built-in clock time)



3 (01min.02 sec. later)

about 15:29:38 (corrected time)

15:36:18 (camera built-in clock time)



4 (01min.26 sec. later)

about 15:30:02 (corrected time)

15:36:42 (camera built-in clock time)



5 (05 min.00 sec. later)

about 15:33:36 (corrected time)

15:40:16 (camera built-in clock time)



6 (05 min.12 sec. later)

about 15:33:48 (corrected time)

15:40:28 (camera built-in clock time)



7 (06 min.08 sec. later)

about 15:34:44 (corrected time)

15:41:24 (camera built-in clock time)



8 (06 min.20 sec. later)

about 15:34:56 (corrected time)

15:41:36 (camera built-in clock time)



9 (06 min.36 sec. later)
about 15:35:12 (corrected time)
15:41:52 (camera built-in clock time)

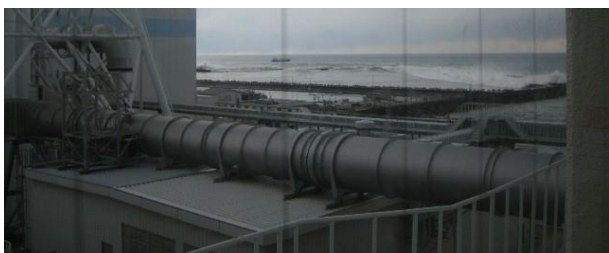

10 (06 min.42 sec. later)
about 15:35:18 (corrected time)
15:41:58 (camera built-in clock time)



11 (07 min.04 sec. later)
about 15:35:40 (corrected time)
15:42:20 (camera built-in clock time)

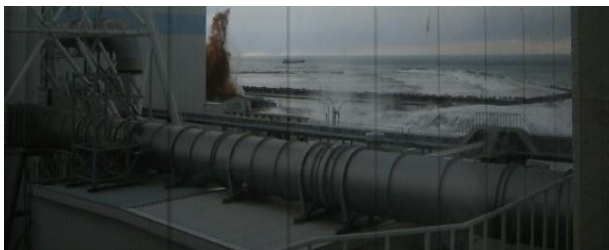

12 (07 min.08 sec. later)
about 15:35:44 (corrected time)
15:42:24 (camera built-in clock time)



13 (07 min.24 sec. later)
about 15:36:00 (corrected time)
15:42:40 (camera built-in clock time)



14 (07 min.30 sec. later)
about 15:36:06 (corrected time)
15:42:46 (camera built-in clock time)



15 (07 min.42 sec. later)
about 15:36:18 (corrected time)
15:42:58 (camera built-in clock time)



16 (07 min.56 sec. later)
about 15:36:32 (corrected time)
15:43:12 (camera built-in clock time)



17 (08 min.10 sec. later)

about 15:36:46 (corrected time)

15:43:26 (camera built-in clock time)



18 (08 min.20 sec. later)

about 15:36:56 (corrected time)

15:43:36 (camera built-in clock time)



19 (08 min.38 sec. later)

about 15:37:14 (corrected time)

15:43:54 (camera built-in clock time)



The above photos are the reproduced ones of those in the text body.

20 (08 min.50 sec. later)
about 15:37:26 (corrected time)
15:44:06 (camera built-in clock time)



21 (09 min.02 sec. later)
about 15:37:38 (corrected time)
15:44:18 (camera built-in clock time)



22 (09 min.14 sec. later)
about 15:37:50 (corrected time)
15:44:30 (camera built-in clock time)



23 (09 min.28 sec. later)
about 15:38:04 (corrected time)
15:44:44 (camera built-in clock time)



24 (09 min.42 sec. later)
about 15:38:18 (corrected time)
15:44:58 (camera built-in clock time)



25 (10 min.50 sec. later)
about 15:39:26 (corrected time)
15:46:06 (camera built-in clock time)



26 (10 min.54 sec. later)
about 15:39:30 (corrected time)
15:46:10 (camera built-in clock time)



28 (13 min.16 sec. later)
about 15:41:52 (corrected time)
15:48:32 (camera built-in clock time)



30 (14 min.42 sec. later)
about 15:43:18 (corrected time)
15:49:58 (camera built-in clock time)



27 (11 min.54 sec. later)
about 15:40:30 (corrected time)
15:47:10 (camera built-in clock time)



29 (14 min.36 sec. later)
about 15:43:12 (corrected time)
15:49:52 (camera built-in clock time)



31 (15 min.06 sec. later)
about 15:43:42 (corrected time)
15:50:22 (camera built-in clock time)



32 (15 min.32 sec. later)
about 15:44:08 (corrected time)
15:50:48 (camera built-in clock time)



33 (16 min.54 sec. later)
about 15:45:30 (corrected time)
15:52:10 (camera built-in clock time)



34 (17 min.06 sec. later)
about 15:45:42 (corrected time)
15:52:22 (camera built-in clock time)



35 (17 min.10 sec. later)
about 15:45:46 (corrected time)
15:52:26 (camera built-in clock time)



36 (17 min.58 sec. later)
about 15:46:34 (corrected time)
15:53:14 (camera built-in clock time)



37 (18 min.28 sec. later)
about 15:47:04 (corrected time)
15:53:44 (camera built-in clock time)



38 (19 min.04 sec. later)
about 15:47:40 (corrected time)
15:54:20 (camera built-in clock time)



39 (22 min.08 sec. later)
about 15:50:44 (corrected time)
15:57:24 (camera built-in clock time)



40 (23 min.44 sec. later)
about 15:52:20 (corrected time)
15:59:00 (camera built-in clock time)



41 (23 min.48 sec. later)
about 15:52:24 (corrected time)
15:59:04 (camera built-in clock time)



42 (24 min.52 sec. later)
about 15:53:28 (corrected time)
16:00:08 (camera built-in clock time)



43 (25 min.44 sec. later)
about 15:54:20 (corrected time)
16:01:00 (camera built-in clock time)



44 (25 min.48 sec. later)

about 15:54:24 (corrected time)

16:01:04 (camera built-in clock time)



[Appendix 3] Setting of distance value from the wave height meter to the southern breakwater flexion

In this current examination, the distance was set as 900 m from the wave height meter to the southern breakwater flexion.

This value can be considered, as shown below, to be slightly longer, i.e., slightly longer time is needed for tsunami propagation.

The positional relation for setting 900 m is seen below, which means that the tsunami wave-front shown by the broken line is assumed to be perpendicular to the two-way arrow).

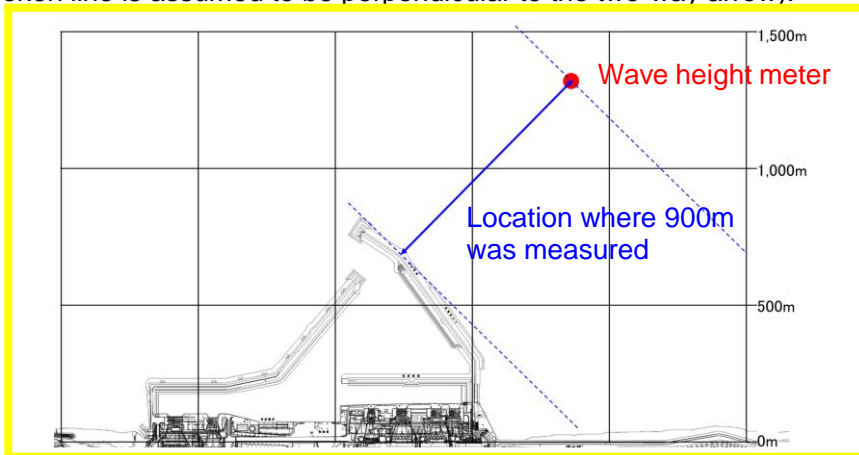

The wave-front obtained by a simulation for tsunami reproduction has the angles shown in the figure below.

In the simulation, wave forms and the arrival timing cannot be precisely reproduced, but the direction of the simulated wave-front can be considered to be close to the real one, because the wave-front is controlled by the seabed topography.

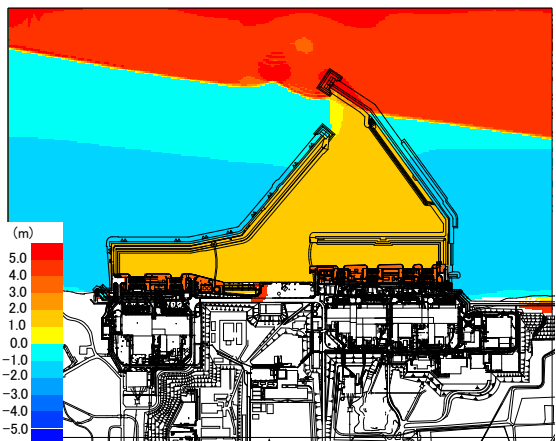

Analytical result (bird's eye view)

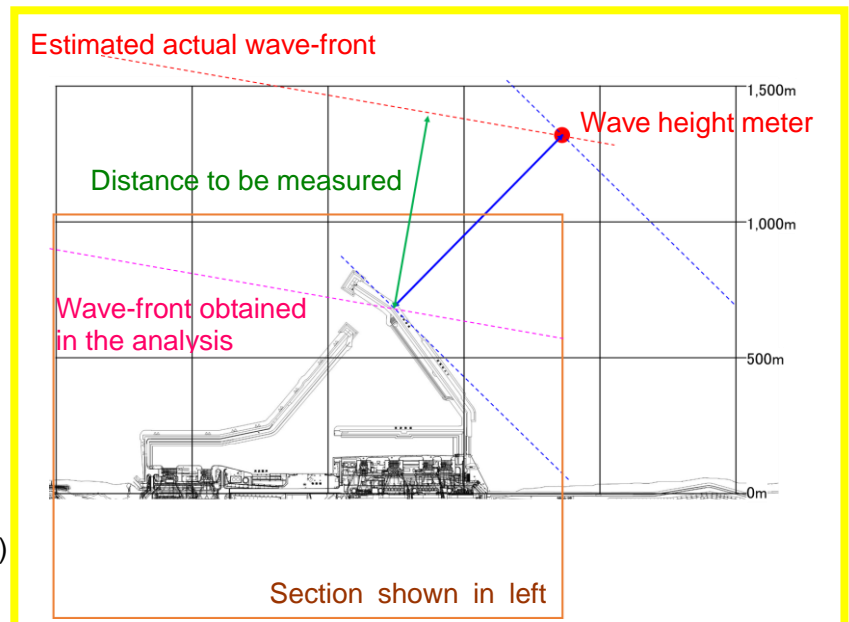

From this consideration, the distance of 900 m is considered to be longer than the real propagation distance of the tsunami, and, therefore, leads to estimation of a longer propagation time.

[Appendix 4] Propagation time of the second wave (first step) from the wave height meter to the southern breakwater

a. Propagation time calculated from estimated velocity based on the still water depth

The still water depth h was used to estimate propagation time on the longer side in the following approach, without considering the tsunami amplitude.

- The distance of 900 m was divided into 18 sections with 50 m each.
- The seabed slope was assumed to be constant from about 13 m at the wave height meter location to about 6 m at the southern breakwater flexion.
- The wave propagation velocity in each section was obtained by combining the approximation formula $c = (gh)^{1/2}$ and the average seabed depth in each section.
- Time needed for tsunami to propagate over each section was calculated.
- As the Table on the next page shows, the tsunami propagation time from the wave height meter location to the southern breakwater flexion was obtained as about 95 s.

b. Propagation time calculated from estimated velocity based on the total water depth

The total water depth (= still water depth + tsunami wave amplitude) was used to obtain a more realistic propagation time.

- The tsunami wave amplitude H_2 was calculated in each section using Green's Rule: $H_2/H_1 = (h_1/h_2)^{1/4}$.
- The initial value of tsunami wave amplitude H_1 was set at 4.5 m from the wave height meter recording of the second wave (first step).
- The initial value of sea depth h_1 was about 13 m at the wave height meter location.
- The propagation time was obtained in the same approach as in a, using the total water depth instead of the still water depth.
- As the Table on the next page shows, the tsunami propagation time from the wave height meter location to the southern breakwater flexion was obtained as about 76 s.

Based on the examination above, the propagation time from the wave height meter to the bay area is estimated as 76 to 95 s.

Distance from wave height meter [m]	a. Examination using still water depth			b. Examination using total water depth			
	Average water depth in each section [m]	Wave velocity obtained from an approximate formula with still water depth [m/s]	Propagation time in each section [s]	Wave amplitude by Green's Rule [m]	Average water depth in each section [m]	Wave velocity obtained from an approximate formula with total water depth [m/s]	Propagation time in each section [s]
0~50	12.8	11.2	4.5	4.5	17.3	13.0	3.8
50~100	12.4	11.0	4.5	4.6	17.0	12.9	3.9
100~150	12.0	10.9	4.6	4.6	16.6	12.8	3.9
150~200	11.6	10.7	4.7	4.6	16.3	12.6	4.0
200~250	11.3	10.5	4.8	4.7	15.9	12.5	4.0
250~300	10.9	10.3	4.8	4.7	15.6	12.4	4.0
300~350	10.5	10.1	4.9	4.7	15.2	12.2	4.1
350~400	10.1	9.9	5.0	4.8	14.9	12.1	4.1
400~450	9.7	9.7	5.1	4.8	14.5	11.9	4.2
450~500	9.3	9.5	5.2	4.9	14.2	11.8	4.2
500~550	8.9	9.3	5.3	4.9	13.9	11.7	4.3
550~600	8.5	9.1	5.5	5.0	13.5	11.5	4.3
600~650	8.1	8.9	5.6	5.1	13.2	11.4	4.4
650~700	7.7	8.7	5.7	5.1	12.9	11.2	4.5
700~750	7.4	8.5	5.9	5.2	12.5	11.1	4.5
750~800	7.0	8.3	6.0	5.3	12.2	10.9	4.6
800~850	6.6	8.0	6.2	5.3	11.9	10.8	4.6
850~900	6.2	7.8	6.4	5.4	11.6	10.7	4.7
	Total propagation time [s]		94.7		Total propagation time [s]		76.1