

Reactor pressure decreasing behavior at about 9:00 on March 13th in Unit-3

1. Outline of phenomena and subjects of investigation.

In Unit-3 of the Fukushima Daiichi Nuclear Power Station, reactor pressure began to increase after the High pressure coolant injection system (HPCI) was manually stopped at 2:42 on March 13th, 2011 and the pressure was kept at about 7 MPa for about 5 hours. At about 9:00 on the 13th, it decreased rapidly to below 1 MPa. This reactor pressure decreasing behavior can be confirmed by 2 types of measurement record data which were measured by the operator (Fig.1) and the recorded chart (Fig. 2). The measured data captured a discrete pressure change but the chart showed a continuous change for which an accurate value is hard to read. The evaluation of these data shows the pressure rapidly dropped from about 7 MPa to about 1 MPa in about 2-3 minutes. This Attachment deals with the cause of the reactor pressure decreasing behavior and investigates measures necessary for dealing with this behavior in the future.

The Government Accident Investigation Report published in July 2012 describes that this pressure behavior is possibly caused by gas leakage from the pressure vessel or its surroundings (such as a flange gasket of the safety relief valve (SRV)) to the drywell (D/W) of the primary containment vessel (PCV) . (Attachment p.158).

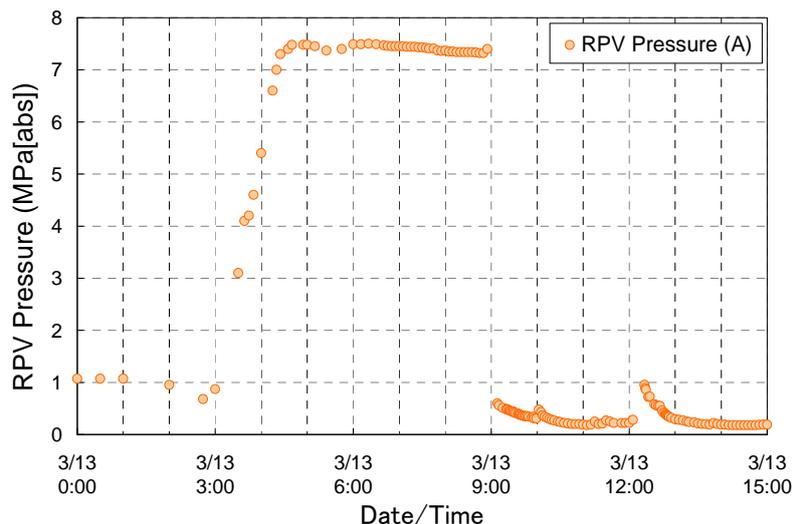

Fig. 1 Measurement data recorded by operator.

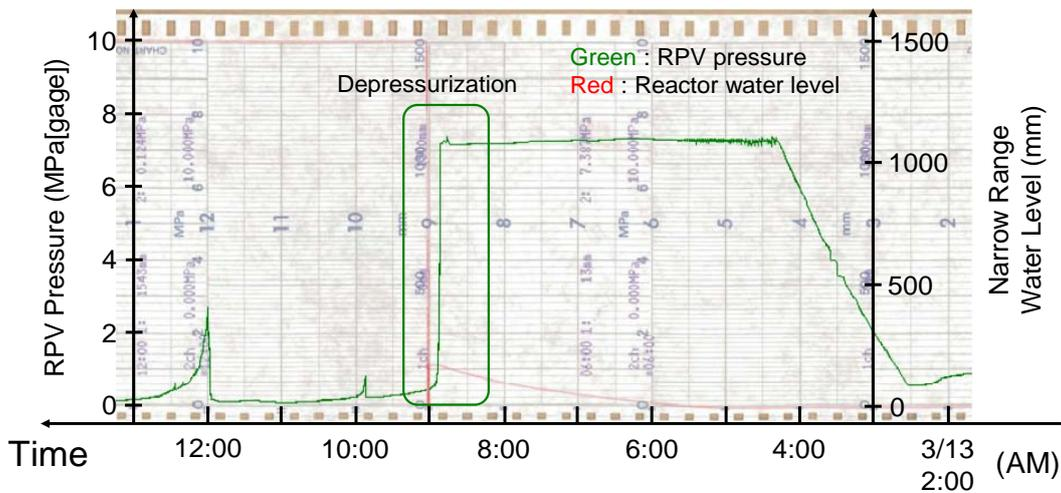
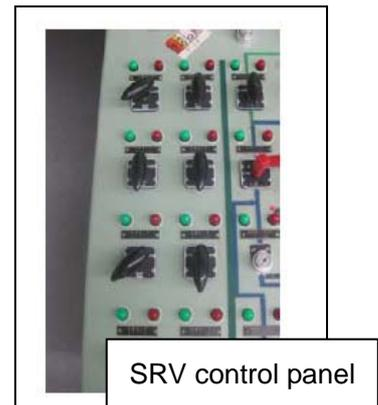

Fig.2 Recording chart.

2. Status of works in the main control room when the reactor pressure decreased

The status of works in the main control room when the reactor pressure decreased is described below.

- At about 9:08 on the 13th, when 2 members of the recovery team started connecting 10 of 12 V batteries in a series circuit, the operator recognized that the reactor pressure was decreasing. At this point, work to connect batteries to SRV control panel was not completed.
- The status indicator on the SRV control panel showed that the red light of SRV(A), the indicator for the valve open (operation), was repeatedly blinking and then green light of SRV(A), the indicator for the valve close, was also lit.
- Immediately, both the red and green lights of the SRV (G) were also lit. The 2 SRVs (A) and (G) were in the half open status.



3. Factors affecting reactor pressure decreasing behavior.

3.1 Analysis results using MAAP code.

In March 2012, TEPCO announced its estimation of the status of the core and PCV obtained using the MAAP code. This analysis was carried out based on the assumption that one SRV was opened at 9:08 on the 13th, which was estimated using the newest (at that time) timeline. Fig. 3-1 shows the analysis results.

At the time of the announcement, depression speeds obtained from the line connecting the 2 red circled measured data and the one obtained from the code analysis were judged to

be almost the same. However, starting below 2 MPa, decreasing behavior of the analysis is more gradual than line obtained by connecting the 2 measured points. This line obtained by connecting the 2 measured points does not show actual pressure decreasing speed, but it only shows the fact that the pressure decrease occurred between 2 points. Information obtained from the chart showed that actual pressure decreasing behavior is faster than this.

As conditions of the MAAP analysis announced in March 2012, 2, 4, 6, and 8 SRVs were assumed to be opened at 9:08. Fig. 3-2 compares the sensitivity analysis with pressure decreasing behavior recorded in the chart. The decreasing speed cannot be reproduced in the cases of opening less than 4 valves, while in the cases of opening 6 and 8 valves almost the same pressure decreasing speed was obtained as that of the recorded chart. Although the pressure decreasing behavior can be reproduced when opening area is similar to that for 6 and 8 SRVs valves and it is necessary to examine if there are other factors affecting the analysis besides the numbers of valves, there is the possibility to reproduce the present depressurization behavior.

The following 2 possibilities can be thought from the sensitive analysis.

- The depressurization was not due to opening of the SRVs, but leakage from the reactor pressure vessel (RPV) to the PCV that occurred through a large hole whose opening area was equivalent to that of 6 or more SRVs. (This is similar to the opinion given by the Government Accident Investigation Report)
- Not only one valve was opened but more than 6 SRVs opened at the same time.

These two possibilities are discussed in chapters 3.2 and 3.3.

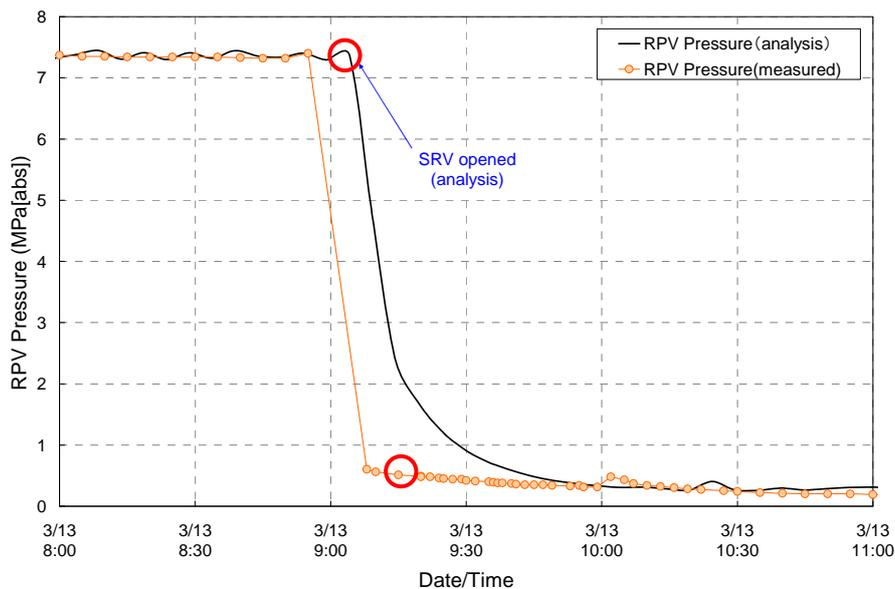

Fig. 3-1 MAAP analysis result (announced in March 2012)

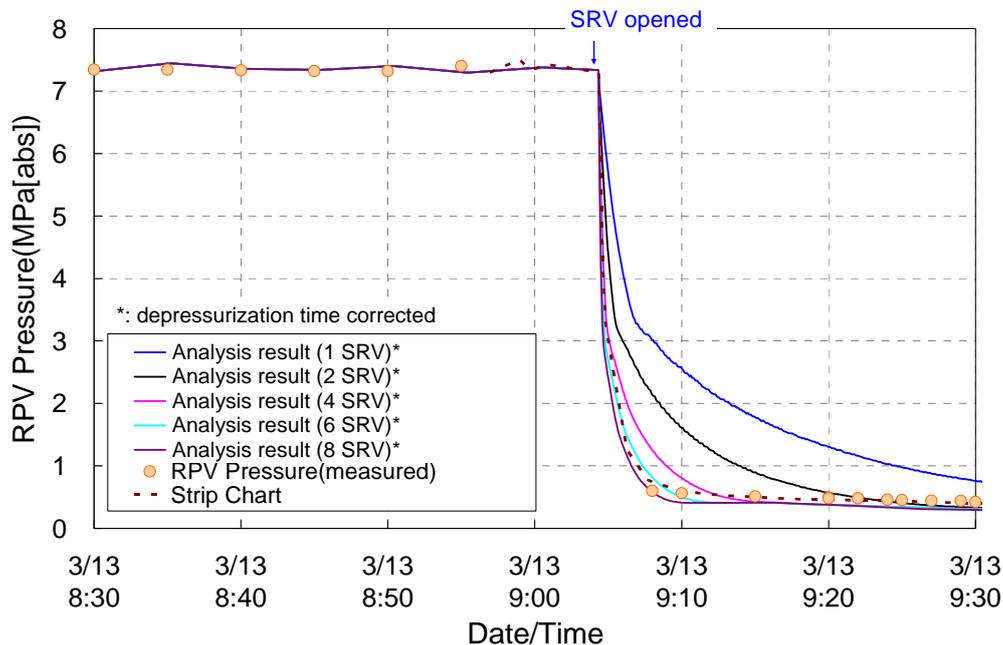

Fig.3-2 Sensitivity analysis by numbers of opening SRVs.

3.2 Leakage from the RPV to the PCV

In estimation of status of the core and PCV using the MAAP code, which TEPCO announced in March 2012, it was assumed in Unit-1 that gas leakage occurred through the dry tube of the in-core instrumentation tube such as the Source Range Monitor (SRM) / Intermediate Range Monitor (IRM) and Traversing In-core Probe (TIP). In addition, gas leakage through the flange gasket of the SRV was also assumed.

In Unit-3, it could be thought that similar gas leakage also occurred finally. However if this depressurization at about 9:00 on the 13th is caused by leakage from the RPV to the PCV (specifically the D/W), it will be difficult to explain the pressure increases of about 1 MPa that occurred at about 10:00 and about 3 MPa that occurred at about 12:00, which is shown in Fig.4. It is true that a rapid pressure increase might occur by relocation of large molten debris or hydrogen generation, even if there are large leakage holes. However, if a large leakage hole, equivalent to the opening of multiple valves more than 4 valves, existed at 9:00, it is hard to think that increasing pressure turns to decrease when the SRV was additionally opened regarding the depressurization behavior at 12:00.

Moreover, if a large leakage hole existed at the RPV bottom, water would fall to the PCV without accumulating in the RPV. On the other hand, if the rapid pressure increase was due to large steam generation by molten debris relocation to lower plenum, there should be

accumulated water to some extent in the bottom of sound RPV as shown in Fig.5. In other words, if both a large leakage hole existed and large steam generation occurred, the large leakage hole should be at the upper part of the RPV or at pipes such as the main steam pipe. However this contradicts the scenario that the leakage hole is made by molten fuel

Therefore, there is a low possibility that the depressurization behavior in question was caused by leakage from the RPV to the PCV (D/W).

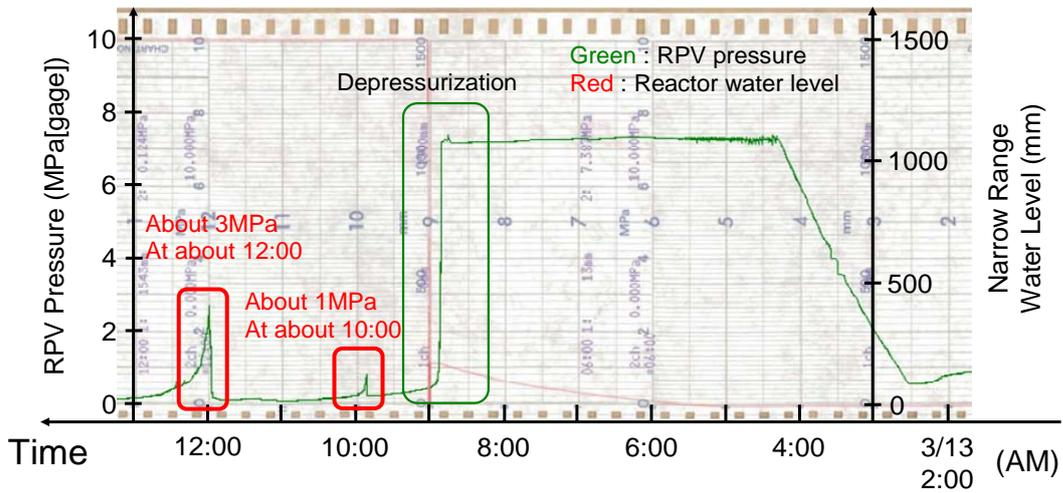

Fig. 4 Reactor pressure increase after depressurization.

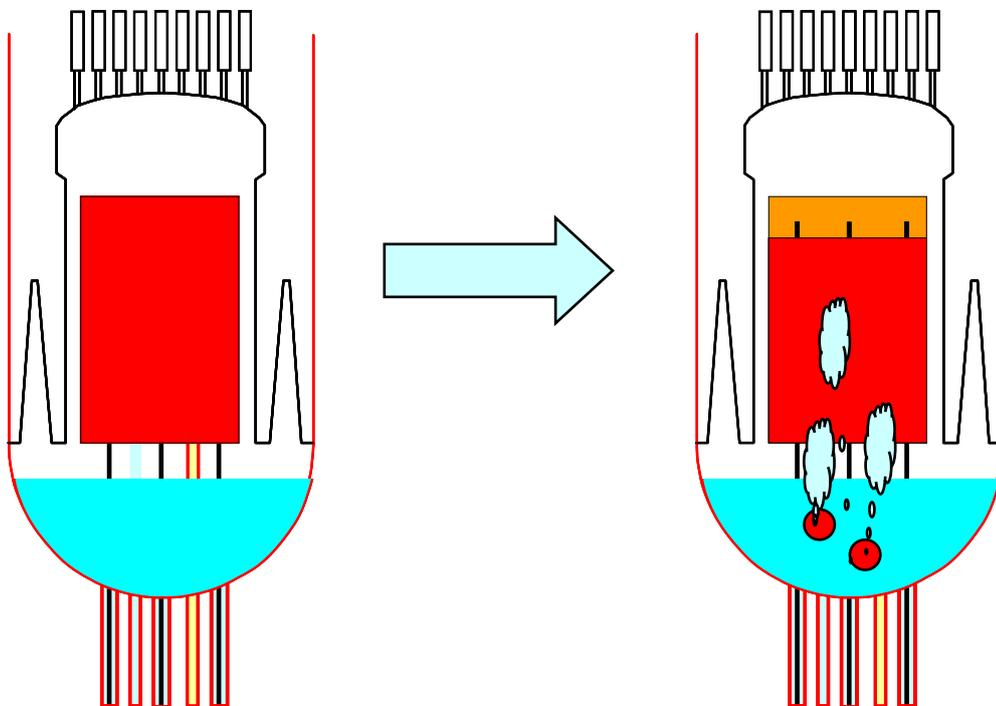

Fig.5 Steam generation and pressure increase (case of molten fuel slumping).

3.3 Regarding the reactor depressurization scenario

As explained in chapter 3.2, there is a low possibility that the depressurization was caused by leakage from the RPV to the PCV, while there is a possibility that depressurization at about 9:00 on the 13th was caused by SRV opening because the indicator in the main control room showed some SRVs were open.

Regarding the numbers of SRVs opened, although the amount of steam generated in the RPV decreases due to the contribution of decompression boiling becoming smaller at about 9:10-9:20 as shown in Fig. 3-2, the reactor pressure decreasing speed for 2 and 4 valves open at this time is slower than the speed of the recording chart. This is proof that the steam cannot be released sufficiently by a small number of valves. Therefore it is thought that more than 6 SRVs were opened instead of 1 valve. As a phenomenon in which two or more SRVs open simultaneously, it is possible that the automatic depressurization system (ADS) function of the SRV operated (6 valves opened), and that the relief valve operated by interlock of the Accident Management (AM) measure (2 valves opened). Therefore, the possibility of operation by interlock of the SRV is investigated in chapter 4.

4. Possibility of operation of the ADS function of the SRV

4.1 Operation logic of the SRV

There are 8 SRVs labeled from A to H. The pressure setpoint for each SRV is shown in Table 1, and Fig 6 shows the logic diagram of SRV operation.

Regarding the relief valve function described below in Fig 6, the possibility for SRV to open by relief valve mode is low for the following reasons. The pressure did not reach the lowest operation pressure setpoint 7.44 MPa (gage) according to the recording chart. The investigation of chapter 3 showed the probability that 2 or more SRVs operated at the reactor pressure decrease. If the relief valve function operates, the valve is shut by the reseating pressure and the reactor pressure is kept high.

Regarding the relief valve operation of A and E by the AM interlock, the possibility is low for the following reasons. A and G were valves for which the indicator showed half open on the SRV control panel in the main control room, as described in chapter 2. Furthermore, according to the depressurization behavior analysis, depression speed was too slow and more SRVs should open simultaneously to reproduce the depression speed.

Possibility of ADS function operating is investigated in the following section. There are 6 valves which have the ADS function: A, B, C, E, G and H.

Table 1. Pressure setpoint of SRVs for relief valve function and safety valve function

unit : MPa[gage]

	A	B	C	D	E	F	G	H
relief valve function	7.51	7.58	7.44	7.58	7.51	7.58	7.51	7.58
safety valve function	7.71	7.78	7.64	7.71	7.64	7.78	7.71	7.78
ADS function	Yes	Yes	Yes	—	Yes	—	Yes	Yes

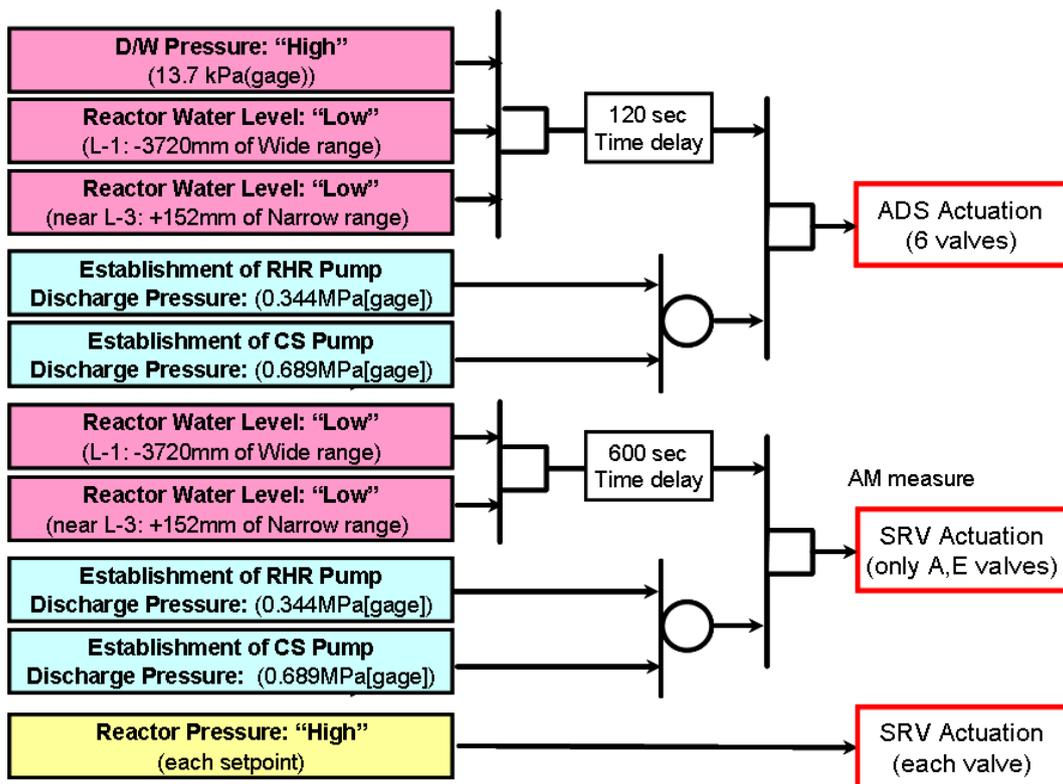

Fig.6 Operation logic of SRV.

4.2 Possibility of operation of the ADS function of the SRV

Possibility of realization of the ADS operation conditions, which are shown in the upper part of Fig. 6, is examined one by one.

Firstly, regarding PCV pressure, the pressure exceeding 13.7 kPa(gage) was observed at 8:55 on the 13th before depressurization, as is shown in Fig.10, and the ADS operation conditions were realized.

Next is reactor water level. There are 2 interlocks necessary for operation. The conditions are that "reactor water level Low (L-1: -3720 mm = TAF + 450 mm)" is established by the wide range water level indicator and "reactor water level Low (L-3: +152 mm = TAF +

4322 mm)” is established by the narrow range water level indicator. In the latter case, TAF + 4170 mm was measured at 15:30 on the 12th during the HPCI operation and the condition was realized. In the former case, accomplishment could not be confirmed for the measured water levels shown in Fig.8. However, very close data to the ADS operating conditions were recorded such as in the record of TAF+537mm at 3:51 on the 13th shown in the taking over diary of the shift operator. This suggests that this condition could be realized with high possibility.

The value of the wide range water level indicator measured between 3:51 and 8:55 on the 13th showed a gradual increase while there was no water injection during this period. Therefore it is thought the water level was not shown correctly at this time due to the temperature increase inside the PCV or evaporation of water inside the reference legs for the wide range water level indicator. It is noticed here that water level transmitter for water level indicator is different from the one for ADS logic input and there is a possibility that ADS operating condition was accomplished.

Finally regarding the discharge pressure of the low pressure coolant injection system, the operator did not operate this system including the RHR and CS. However the S/C pressure, 0.354 MPa (gage), measured at 8:55 is very close to the condition of discharge pressure, 0.344 MPa (gage).

Fig. 9 shows the residual heat removal (RHR) system configuration. The discharge pressure gage of the RHR is connected by the suction line from the S/C, which is the water source, and the valve in the middle is normally operated as open. As is shown by the red arrow in Fig.9, it is possible that the pressure of the S/C is transferred to the discharge pressure gage resulting in the pressure gage detecting the discharge pressure of the RHR by mistake.

Namely, ADS operation conditions were possibly accomplished by establishment of the discharge pressure of the low pressure coolant injection system.

As explained above, there is a possibility that the necessary conditions to operate ADS were all established and reactor pressure decreasing behavior that occurred at about 9:00 was probably due to operation of the ADS function of the SRV. The depressurization behavior suggested the possibility of two or more valves being opened simultaneously. From the sensitivity analysis by the MAAP code, depressurization behavior can be reproduced for 6 valves opening by ADS operation. However the fact that indicators of 4 other valves did not show they were open in the main control room while the indicators of SRVs A and G showed they were half open should be investigated more.

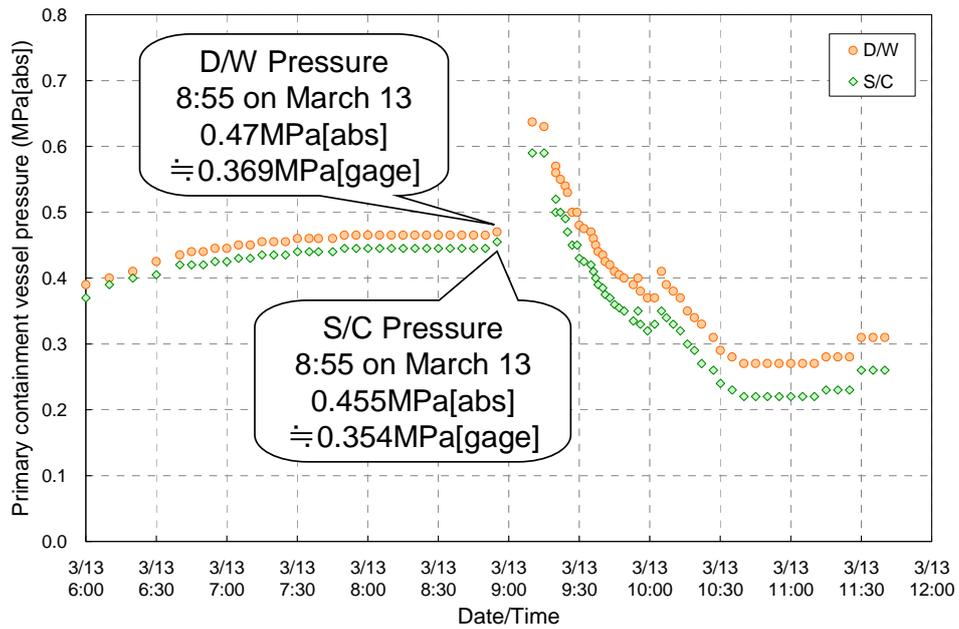

Fig 7. Actual measurement values of pressure of the primary containment vessel (PCV)

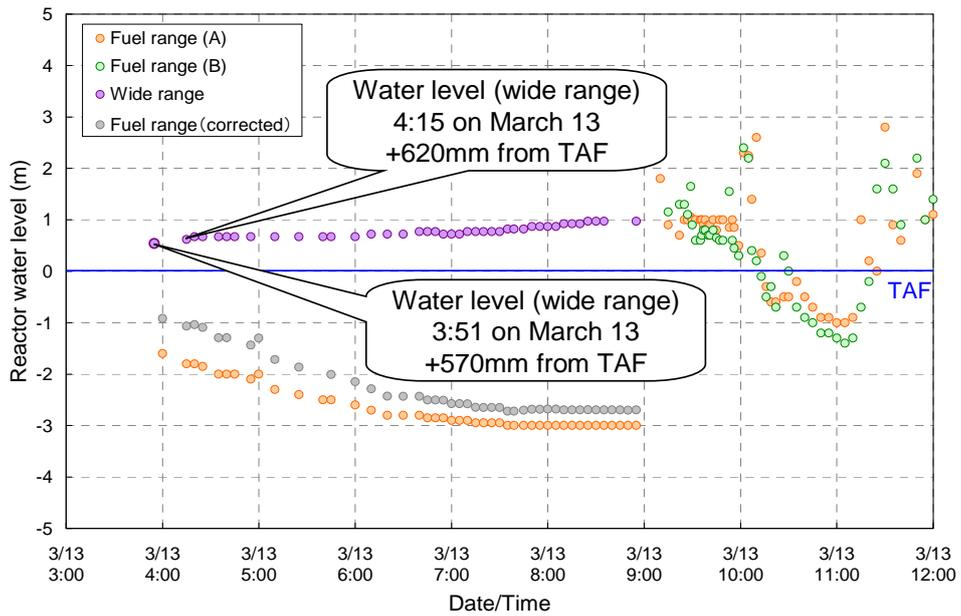

Fig. 8 Actual measurement values of reactor water level

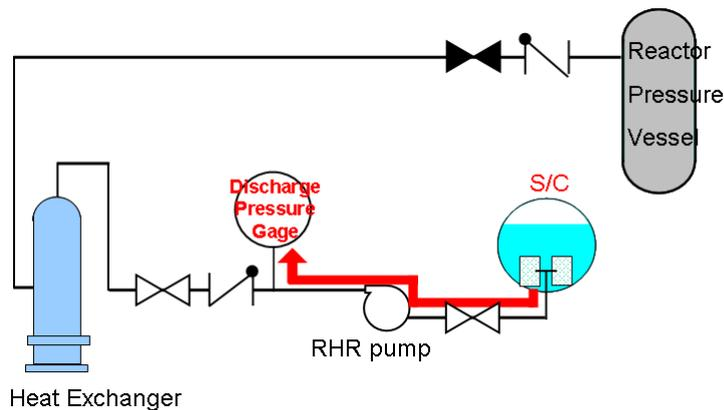

Fig. 9 Configuration of RHR system.

4.3 Drive power supply and drive nitrogen supply

In order to operate the ADS function, a drive power supply is necessary. Fig. 10 shows ECWD of SRV A. Drive power supply is DC125V (subsystem-A or -B).

In order to confirm if the power supply of DC125V was useable, related timeline information on the 13th was confirmed and summarized below.

- At 2:45 just after the HPCI stopped, operation to open SRV A (relief valve function, ADS function) was carried out but it did not open.
- Then operation to open all SRVs (relief valve function, ADS function) was carried out but they did not open.
- At 3:38, operation to open all SRVs (relief valve function, ADS function) was carried out again but they did not open.
- At 3:39, the auxiliary oil pump (AOP) of the HPCI was manually stopped to save DC power.
- At 4:06, the condensate pump of the HPCI was manually stopped to save DC power.

As described in the timeline, SRVs were not opened when it was tried to manually operate the ADS function before 9:00 on the 13th. As it is understood from the fact that the recovery team tried to connect a battery to operate the SRVs at 9:00 on the 13th, the power supply necessary for driving the SRVs might be lost. However, the AOP and condensate pump are driven by a DC power supply and by stopping them sequentially, the load on the DC power supply was reduced. Therefore power supply capacity necessary to operate the ADS function of the SRVs was possibly secured.

In addition, regarding driving nitrogen, since interlock logic to operate the ADS function was not accomplished before the tsunami hit and no evidence was seen that the ADS function operated after that, it is thought that nitrogen in the accumulator was kept filled.

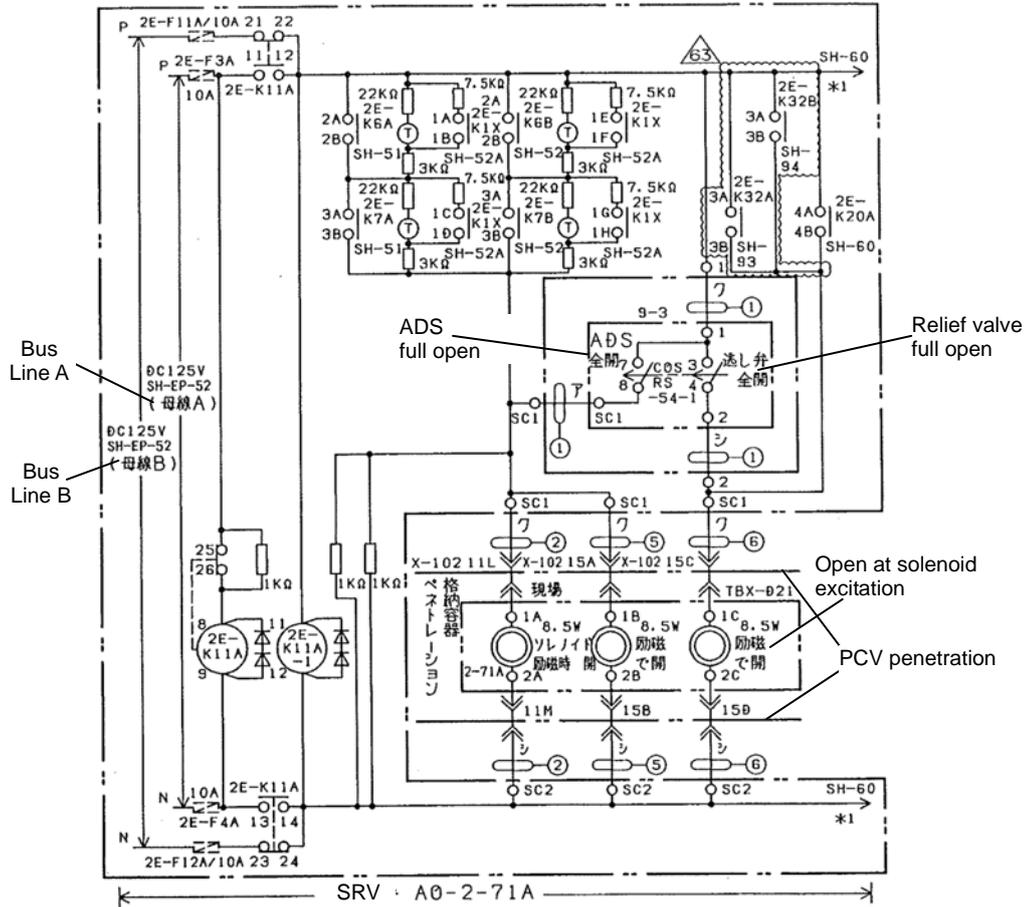

Fig.10 ECWD of SRV A

4.4 Investigation regarding amount of steam generated by decompression boiling

Fig. 11 shows the amount of steam generated in the RPV obtained by analysis. Steam generation was about 5 kg/s by decay heat until the SRV opened and it increased considerably in each case due to decompression boiling caused by SRV opening. As for the analysis result shown in Fig.11 analysis points are coarse and the result shows steam amount of 300 kg/s was instantaneously generated when 8 SRVs were opened.

Thus, the amount of steam generated by decompression boiling was much larger than amount generated by decay heat and it is understood that decreasing speed of reactor pressure was determined by the amount of steam of decompression boiling.

Since the decompression boiling occurs by change of the saturation temperature due to pressure change, the amount of steam generated in the RPV becomes larger as the amount

of water contained in RPV is larger. That is, the amount of steam generated by decompression boiling is larger as reactor water level is higher. In the MAAP analysis announced in March 2012, there is a possibility that reactor water level at 9:00 on the 13th, when decrease of reactor pressure was observed, could be overestimated according to comparison with measurement result. Therefore, since this overestimate of amount of steam was used, the depressurization behavior of the reactor is possibly incorrectly evaluated.

Therefore, the possibility of the overestimation of reactor water level is investigated. Fig. 12 shows the reactor water levels for actual measurements and for the analysis which was announced in March 2012. In order to examine the reactor water level at this time, operation status of HPCI, which was operated until 2:42 on the 13th, should be focused on. The operating status is described below.

At 12:35 on the 12th, the HPCI automatically started due to the signal of reactor water low (L-2). In order to avoid automatic stopping of the HPCI by reaching the signal of reactor water high (L-8), the operators were controlling the flow rate by the Flow Indication Controller (FIC) and they were returning part of the injected water to the Condensate Storage Tank (CST) using the test line. At about 20:36 on the 12th, power supply for the reactor water level measurement was lost and monitoring of water level became impossible. In order to inject water securely to the reactor, the operators raised the preset value of the HPCI flow rate a little and confirmed operating status of HPCI by reactor pressure and discharge pressure of the HPCI pump. Later, the rotation speed of the HPCI turbine became lower than the operating speed region described in the operation manual, and water injection status became unknown because discharge pressure of the HPCI pump and reactor pressure became balanced. The HPCI was manually stopped at 2:42 on the 13th for the following reasons. Steam leakage due to equipment damage was suspected. Some time had passed after the operators went to the field for low pressure water injection by DDFP so the switch of the injection line was thought to be completed. Status indicator for SRV was lit and operation was thought to be possible.

In the analysis, the water injection rate by the HPCI was reduced from 20 t/h to 8 t/h after 20:36 on the 12th when water level could not be seen. When measurement became possible, reactor water level of the fuel range level indicator was much lower than the TAF. This is very different from the analysis.

As described above, because reactor water level in the analysis was higher than measurement, and because reactor pressure and discharge pressure of the HPCI pump became balanced during HPCI operation, it is highly possible that HPCI lost water injection capability to reactor before the manual stop at 2:42 on the 13th.

If water injection to the reactor by the HPCI stopped before 2:42, this can be the reason for overestimation of reactor water level by analysis.

Fig. 13 shows analysis results of water level difference at depressurization; it should be noted that these are results of the SAMPSON code. Water level at depressurization was Bottom of Active Fuel (BAF) +300 mm and analysis is performed for the case of water level at BAF during opening of 6 valve. The analysis results when reactor water level was BAF (= case of reactor water volume is small) show that the decreasing behavior of reactor pressure is closer to the one shown in the chart.

Based on the above discussion, although the MAAP analysis announced in March 2012 overestimated reactor water level at about 9:00 on the 13th, it is clear that the effect of this overestimation on decreasing behavior of reactor pressure at this time is small.

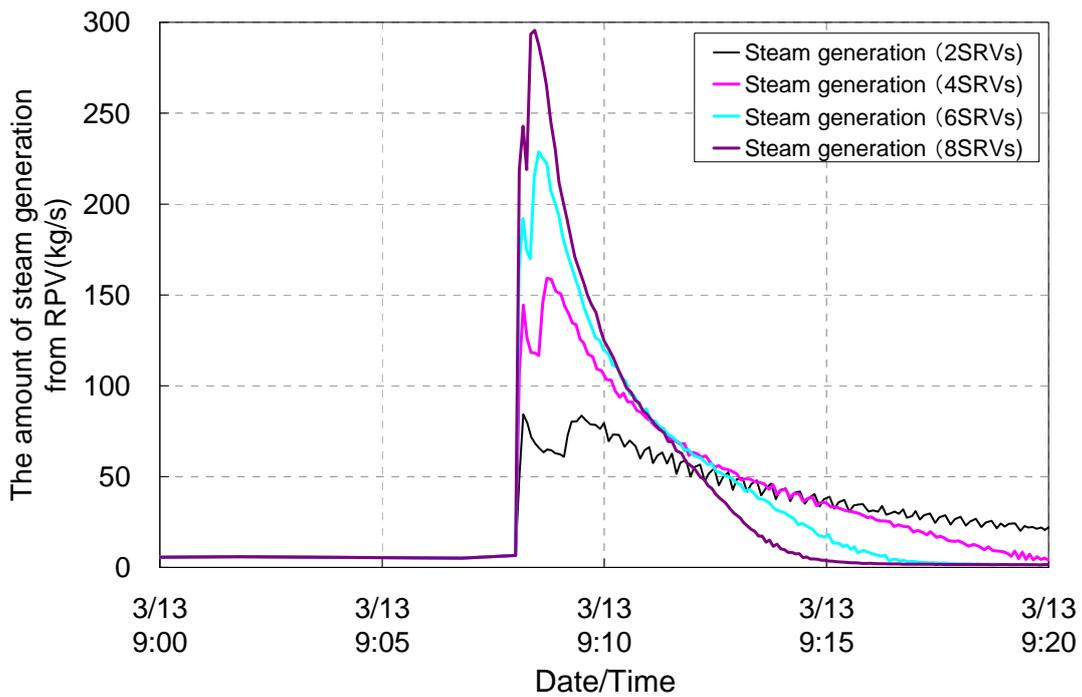

Fig.11 Amount of steam generated from the reactor pressure vessel (RPV).

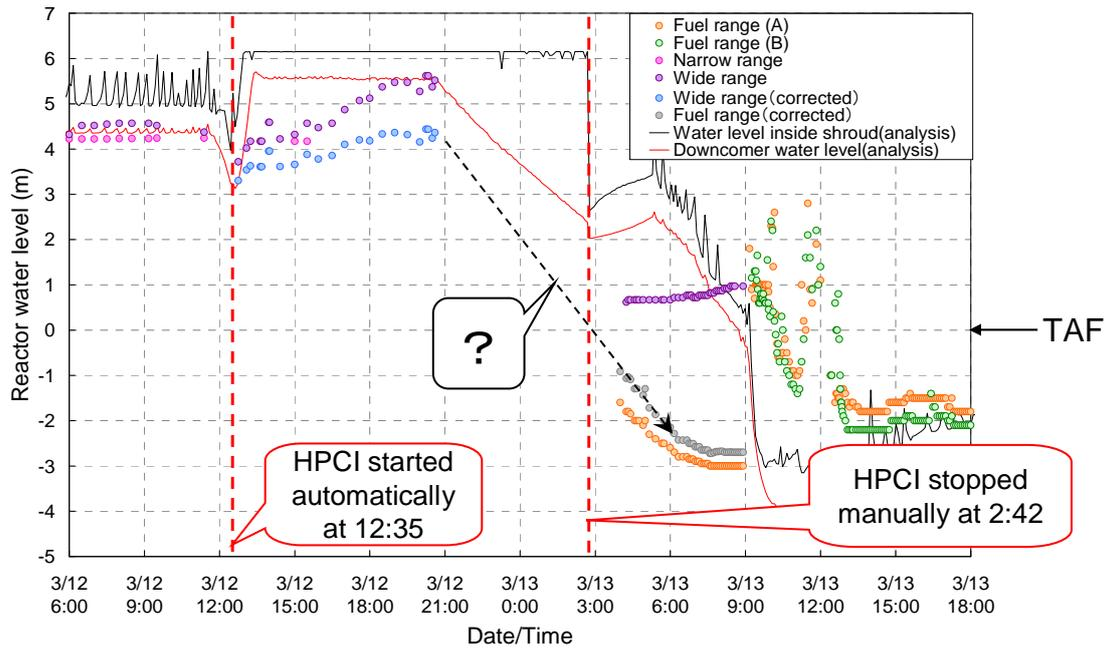

Fig. 12 Results of actual measurement and analysis.

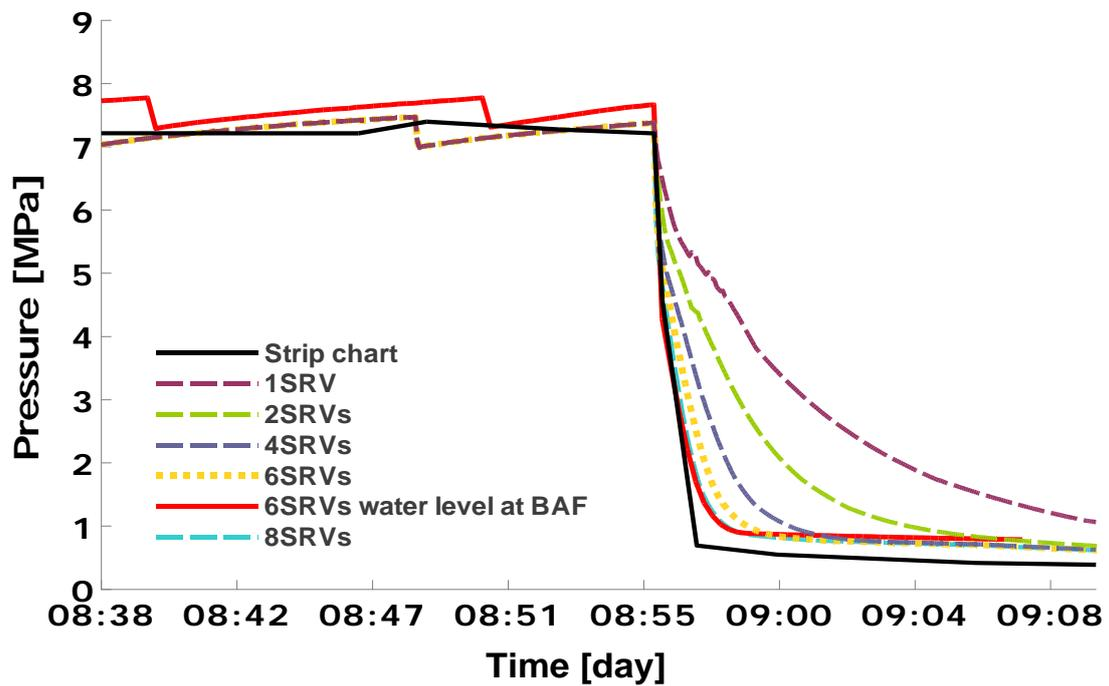

Fig. 13 Analytical results of SAMPSON code.

5. Summary on cause of depressurization behavior

Regarding the cause of the reactor pressure decreasing behavior that occurred at about 9:00 on the 13th, the items examined in chapters 3 and 4 are summarized as follows.

- The possibility is low that the reactor was depressurized by gas leakage from the RPV or its surroundings to the D/W, which was postulated by the Government Accident Investigation Report
- Depression speed on the chart was faster than the speed obtained by the MAAP analysis announced in March 2012.
- There is a possibility that the HPCI lost its water injection function before being manually stopped.
- According to the results of sensitivity analysis of the numbers of SRVs opened and the situation of the SRV status indicator lights in the main control room, it is thought that more than 6 valves were opened at the depressurization at 9:00 on the 13th.
- The possibility is high that the depressurization at 9:00 on the 13th was caused by operation of the ADS function of the SRVs.

6. Relationships between issues identified and measures.

Issues identified for these phenomena and measures currently dealing with them are described below. It should be noted that measures described are not sufficient and that further examinations should be made to respond appropriately to the identified issues.

- Operation to open SRV requires time at shifting to low pressure water injection.
→Maintaining the depressurized state of reactor is important for performing low pressure water injection. Measures including “installation of spare battery and spare nitrogen cylinder for operation of the main steam relief safety valve” and “installation of air compressor for driving main steam relief safety valve” were carried out. However, it was pointed out that the SRV could be manually opened, when manual operation of SRV opening was carried out before battery was connected to SRV, after load to DC is disconnected by stopping the AOP and condensate pump. This is an important issue to understand what kind of status requires a spare battery and spare nitrogen cylinder. That is, it is also important to secure the completeness of the measures like software to detect deterioration of the depressurization function from the normal operation status.
- Regarding operating and stopping of the HPCI, assessment of water injection status should be carried out with highest priority. Accurate assessment and accurate judgment at an appropriate time were not carried out in the main control room and the emergency response center (ERC) at the power station.

→This depressurization phenomenon could probably be caused by ADS operation by misdetection of establishment of the discharge pressure of the low pressure coolant injection system (RHR) during S/C pressure increase. Therefore, under the situation of insufficient water injection, this resulted in loss of a large amount of coolant by decompression boiling. However it cannot be said that this setup caused aggravation of the plant state, because the rupture disc in the vent line was broken by this depressurization and the early achievement of decompression was indispensable anyway.