

List of issues to be investigated

Category: Extracted issues are streamlined for each reactor unit and categorized as follows.

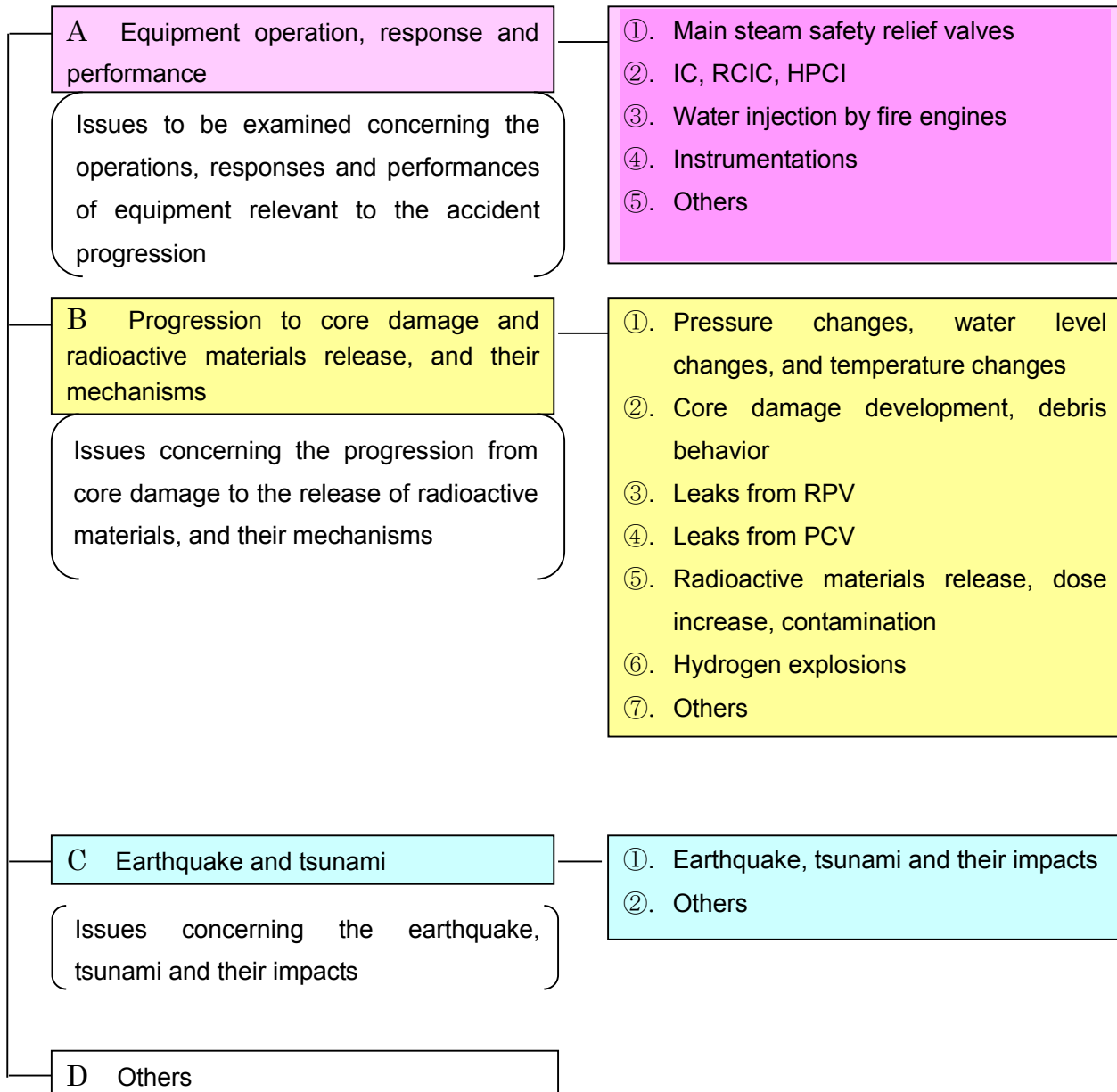

Class: The extracted issues are classified as follows, depending on their influence to the event tree analysis of the accident progression scenario in Figure 1 of the report main body.

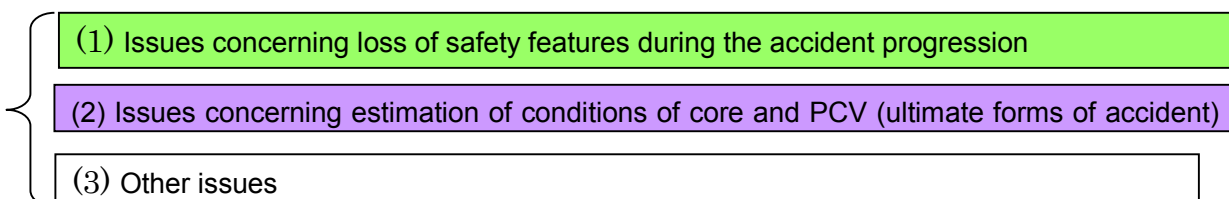

For the issues classified as (1) above, relevant measures to prevent and mitigate the accident progression in Reference [1] are cited.

Each issue is presented in the following tabular form.

Issue No.	Category	Class	Relevant pages in reference [1]
Issue name			Evaluation report, if available
Outline of the issue			

Reference [1] "Safety measures at the Kashiwazaki-Kariwa Nuclear Power Station of Tokyo Electric Power Company (First version, March 2013)"

List of issues

Common

Issue No.	Issue name	Relevant attachment
Common/Issue-1	SRV operations after core damage	
Common/Issue-2	Amounts of water injected to the reactor by fire engines	1-4, 1-5
Common/Issue-3	Water evaporation in the reference leg of water level indicators	1-6
Common/Issue-4	Water leaks from PLR pump mechanical seals	
Common/Issue-5	Core-concrete reactions	
Common/Issue-6	Molten core behavior on falling to the lower plenum	
Common/Issue-7	Correlation between the timing of a large amount of radioactive materials released to the air and the monitoring data	
Common/Issue-8	Radioactive materials release behavior at the time of PCV venting	
Common/Issue-9	Air dose increases on around March 20 th	3-6
Common/Issue-10	Core damage and the location of core debris	
Common/Issue-11	Reactor building hydrogen explosions	
Common/Issue-12	Knowledge about massive synchronized earthquakes with accompanying tsunami	
Common/Issue-13	Intensified seismic activities in the southern area of Hama-dori in Fukushima Prefecture	
Common/Issue-14	Exact timing of the tsunami wave arrivals at major buildings of the Fukushima Daiichi NPS and their inundation routes	Earthquake-tsunami-1
Common/Issue-15	Impacts of tsunami wave forces	
Common/Issue-16	Investigation from the viewpoint of human factors	

Unit-1

Unit-1/Issue-1	Deterioration of IC heat removal performance due to hydrogen gas in Unit-1	1-7
Unit-1/Issue-2	Plant behavior if the Unit-1 ICs had functioned	1-7
Unit-1/Issue-3	RPV water level indicator readings at Unit-3 after loss of true value indications	1-6
Unit-1/Issue-4	LOCA possibility at Unit-1 due to the earthquake	1-3
Unit-1/Issue-5	Leaks in gaseous phase from Unit-1 RPV	
Unit-1/Issue-6	Leaks in gaseous phase from Unit-1 PCV	
Unit-1/Issue-7	Dose rate increase in Unit-1 reactor building on March 11 th	
Unit-1/Issue-8	Causes of high contamination in the southeast area of the ground floor in the Unit-1 reactor building	
Unit-1/Issue-9	Causes of high dose contamination around the Unit-1 RCW piping	
Unit-1/Issue-10	High dose rates contamination near the Unit-1 SGTS piping	
Unit-1/Issue-11	Impacts of water injection interruptions on the accident progression	

Unit-2

Unit-2/Issue-1	RCIC flow rates after loss of DC power supply at Unit-2	2-4
Unit-2/Issue-2	Cause of RCIC shutdown at Unit-2	
Unit-2/Issue-3	Behavior of S/C pressure indicator of Unit-2 after 21:00 on March 14 th	
Unit-2/Issue-4	Unit-2 RHR system operating conditions after tsunami arrival	2-5
Unit-2/Issue-5	PCV pressure behavior at Unit-2 after about 13:00 on March 14 th	2-6
Unit-2/Issue-6	PCV pressure behavior upon forced SRV opening at Unit-2	
Unit-2/Issue-7	RPV pressure increase after forced depressurization at Unit-2	2-7, 2-9
Unit-2/Issue-8	Leaks in gaseous phase from Unit-2 RPV	
Unit-2/Issue-9	Consideration of possible rupture disc actuation at Unit-2	4
Unit-2/Issue-10	Condensation behavior upon hydrogen-rich steam release at Unit-2	2-8
Unit-2/Issue-11	Leaks in gaseous phase from the Unit-2 PCV	
Unit-2/Issue-12	Sharp increase of CAMS readings on March 15 th at Unit-2	2-10
Unit-2/Issue-13	Grounds for no hydrogen explosion at Unit-2	

Unit-3

Unit-3/Issue-1	Causes of repeated shutdown of RCIC at Unit-3	3-5
Unit-3/Issue-2	RPV water level indicator readings at Unit-3 after loss of true value indications	
Unit-3/Issue-3	Thermal stratification in the S/C of Unit-3	
Unit-3/Issue-4	Reactor water level behavior during HPCI in operation at Unit-3	3-3
Unit-3/Issue-5	Reactor water level behavior after the loss of function of HPCI at Unit-3	3-3, 3-4
Unit-3/Issue-6	Rapid depressurization at about 09:00 on March 13 th at Unit-3	3-3, 3-4
Unit-3/Issue-7	RPV pressure behavior after rapid depressurization at Unit-3 on March 13 th	3-3
Unit-3/Issue-8	PCV pressure behavior upon venting operations at Unit-3	
Unit-3/Issue-9	Leaks in gaseous phase from Unit-3 RPV	
Unit-3/Issue-10	Leaks in gaseous phase from Unit-3 PCV	
Unit-3/Issue-11	Large amount of steam discharge from the top of Unit-3 R/B	
Unit-3/Issue-12	Impacts of water injection interruptions on the accident progression	

Common/Issue-1	Common	Category A①	Class (1)	Safety measures in [1]: pp.33-34
SRV operations after core damage			Results: Attachment 1-3, 2-12, 3-4	

Ultimately, Unit-1 to Unit-3 lost all their water injection functions which had been expected to work in an accident, and fire engines were alternatively used for the emergency water injection. For water injection by low pressure injection means, it is necessary to keep the main steam safety relief valves (SRVs) open and depressurize the reactors.

However, temporary batteries were needed to open the SRVs because DC power supplies necessary for opening SRVs had been lost, and many attempts were made to keep open the SRVs. Nevertheless, the reactors could not have been always depressurized.

For example, at Unit-3, the SRV opening operation was attempted from the main control room (MCR) control panel after the HPCI had been manually shutdown at 02:42 on March 13, but no response was observed in the reactor pressure. Therefore, the operators recognized that the SRVs had not worked.

An accumulator was in place to enable SRV opening even when nitrogen gas cylinders or the instrument air system could not provide necessary driving air for the opening. In an accident, nitrogen gas from the cylinders or the instrument air system is isolated in the design upon the loss of the AC power supplies. Therefore, SRVs are considered to have been in a situation to receive their driving air from the accumulator.

Possible causes of SRV failure to function may include insufficient pressure of driving nitrogen gas and the insufficient voltage to activate motor-operated valves. But other relevant matters, such as the SRV opening/closing operation after core damage or reactor pressure changes, are also to be examined in order to clarify the causes why the SRVs did not function, because there is not enough knowledge on the SRV functionality under severe accident conditions.

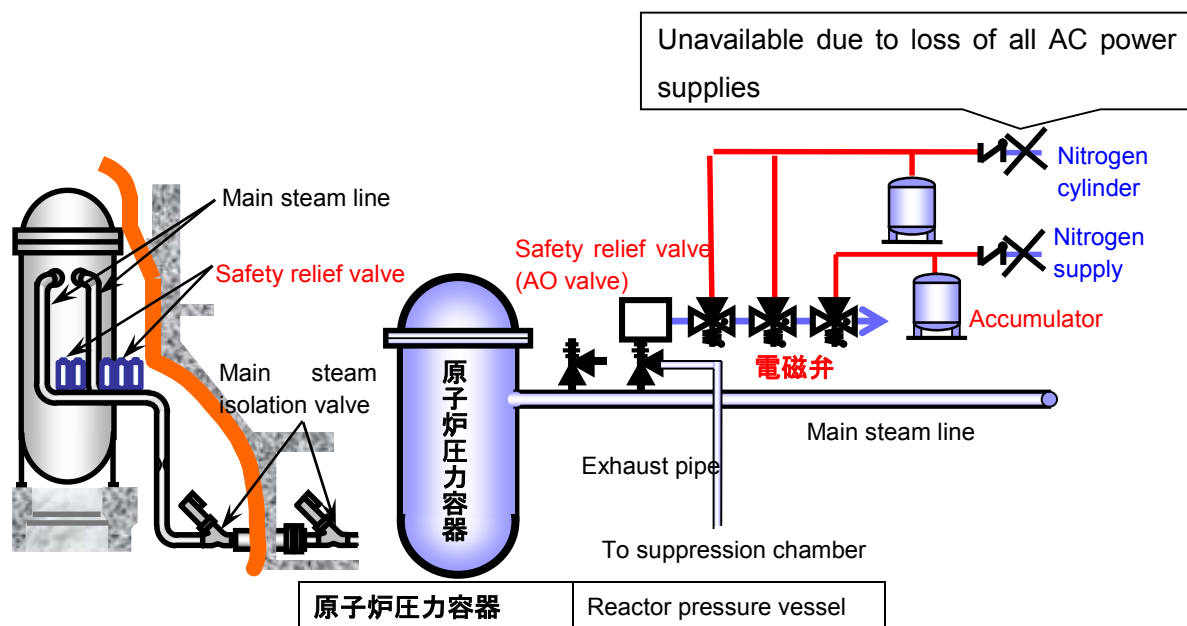

Figure Schematics of the main steam safety relief valves.

[Back to List of Issues/Common](#)

<List of issues – Common ->

Common/Issue-2	Common	Category A③	Class (1)	Safety measures in [1]: p36
Amounts of water injected to the reactor by fire engines				Results: Attachment 1-4, 1-5
<p>Ultimately, Unit-1 to Unit-3 lost all their water injection functions which had been expected to work in an accident, and fire engines were alternatively used for the emergency water injection.</p> <p>The information relevant to the amount of water injected was compiled as the estimated amount (daily average of the amount injected) based on the discharge pressure of fire engines and flow rate indicator readings at the time of the accident. But their accuracies are not satisfactory, and part of the water injected is considered to have flowed to other systems and equipment, bypassing the water injection line to each reactor unit.</p> <p>At Unit-1, for instance, water injection was interrupted at 01:10 on March 14th. At 20:00 on the same day, water injection was resumed (via the reactor core spray system), but no reactor pressure increase was observed, indicating a possibility of no water, or only a small amount, being injected. At 02:33 on March 23rd, when the reactor feedwater system started to inject water, the reactor and PCV pressure increased, probably due to steam generation. This indicates a possibility of no water, or only a small amount, having been injected before.</p> <p>In the MAAP analysis, the amount of water injected to the reactor was set substantially less than the amount of water injected by fire engines, in order to simulate the observed PCV pressure changes. The amount of water injected to the reactor is of critical importance in examining the accident progression. Therefore, the actual amount of water injected to the reactor needs to be clarified because it has a big uncertainty.</p>				

<List of issues – Common ->

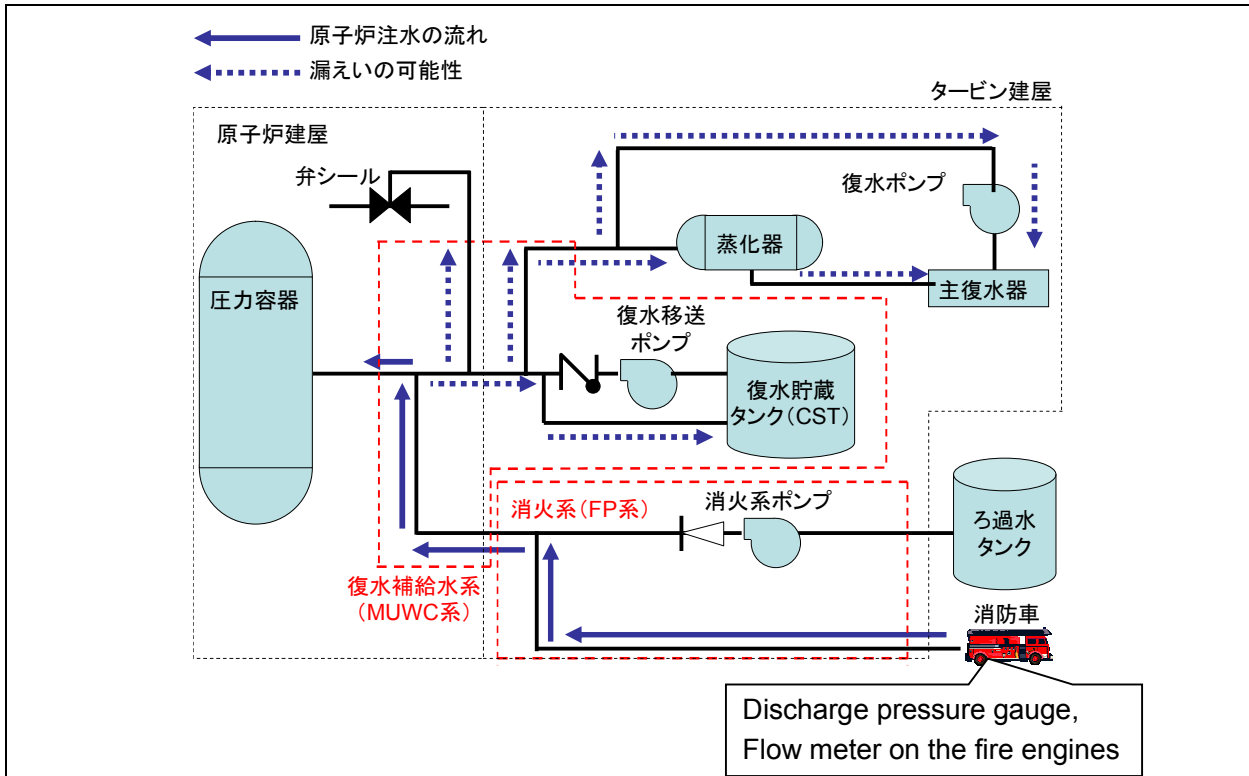

消防車ポンプ吐出圧力計・流量計	Discharge pressure gauge, Flow meter on the fire truck
原子炉注水の流れ	Alternative water injection lines to reactor
漏えいの可能性	Possible leak paths

Figure Schematics of alternative water injection lines using fire engine pumps

[Back to List of Issues/Common](#)

Common/Issue-3	Common	Category A⑤	Class (2)	Safety measures in [1]: -
Water evaporation in the reference leg of water level indicators				Results: Attachment 1-6

At Unit-1, the reactor water level could not be temporarily measured after the station blackout caused by the tsunami. When the reactor water level indicators were restored by temporary battery supplies at 21:19 on March 11th, the water level indicators showed an increase despite the fact that no water was being injected into the reactor. In view of the measurement principle of water level indicators, the apparent increase of the water level is considered to be due to incorrect readings caused by water evaporation in the reference leg (piping on the reference water level side) of the water level indicators. Ultimately it is considered that Unit-2 and Unit-3 also experienced similar incorrect readings of the water level indicators.

Examination is to be done to clarify when and why the water level indicators began to give incorrect readings, because it may provide some clues to estimate the reactor situations at those times.

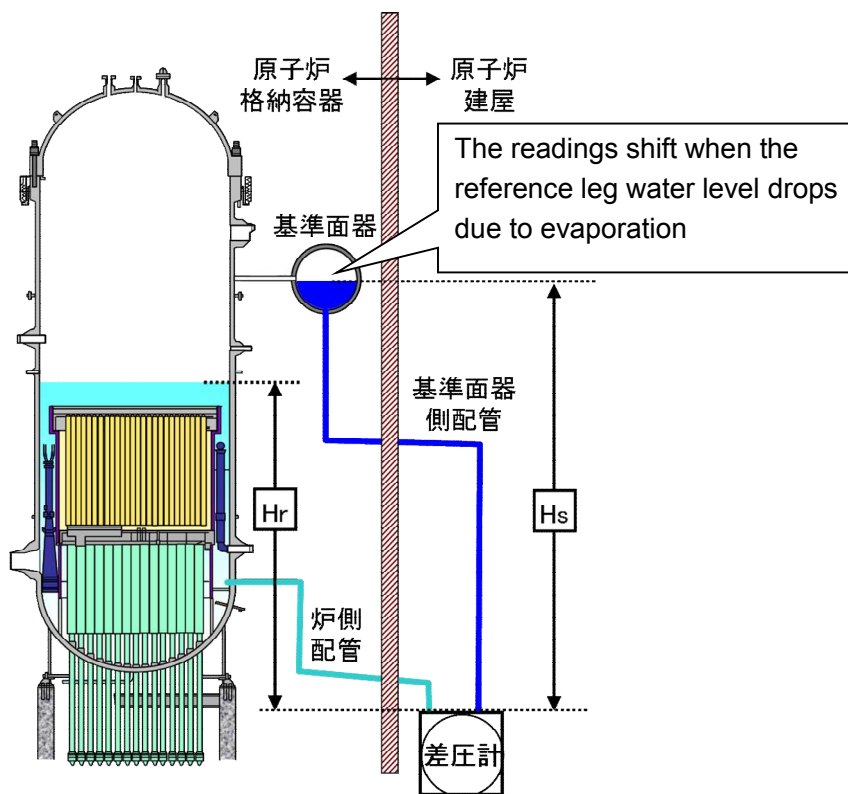

差圧計	Differential pressure transmitter
-----	-----------------------------------

Figure Working principle of reactor water level indicators

[Back to List of Issues/Common](#)

Common/Issue-4	Common	Category A⑤	Class (2)	Safety measures in [1]: -
Water leaks from PLR pump mechanical seals				Results: -

Mechanical seals are mounted on the primary loop recirculation (PLR) pumps as the shaft seal. During normal operations, sealing water for the shaft seals provided from the control rod drive (CRD) pumps prevents reactor water from leaking. When the external power supply is lost, CRD pumps are shut down and sealing water is lost from the CRD pumps; then the high pressure reactor water is discharged to the drywell (D/W) equipment drain sump via the PLR pump shafts and shaft seals.

As a matter of fact, at Unit-4 of the Fukushima Daini NPS, which did not need to run the D/W spray, it was found during a post-earthquake patrol in the PCV that water had filled the pedestal, which had housed the equipment drain sump, and reached even the diaphragm floor (the D/W bottom floor). Water discharge from the equipment drain sump stopped after the earthquake. Therefore, it is highly possible that this water was the leaked water from the reactor via the PLR pump shafts

As long as the mechanical seals are not damaged, the water leak from the reactor is expected to be below the design leak rate and has little impact on the reactor behavior. But, if the seal functions were lost in the process of accident progression, as O-ring damage for instance, the leak rate might have increased. It is necessary to clarify whether leaks actually occurred which might have influenced the reactor water levels, and the PCV temperatures, pressures and water levels.

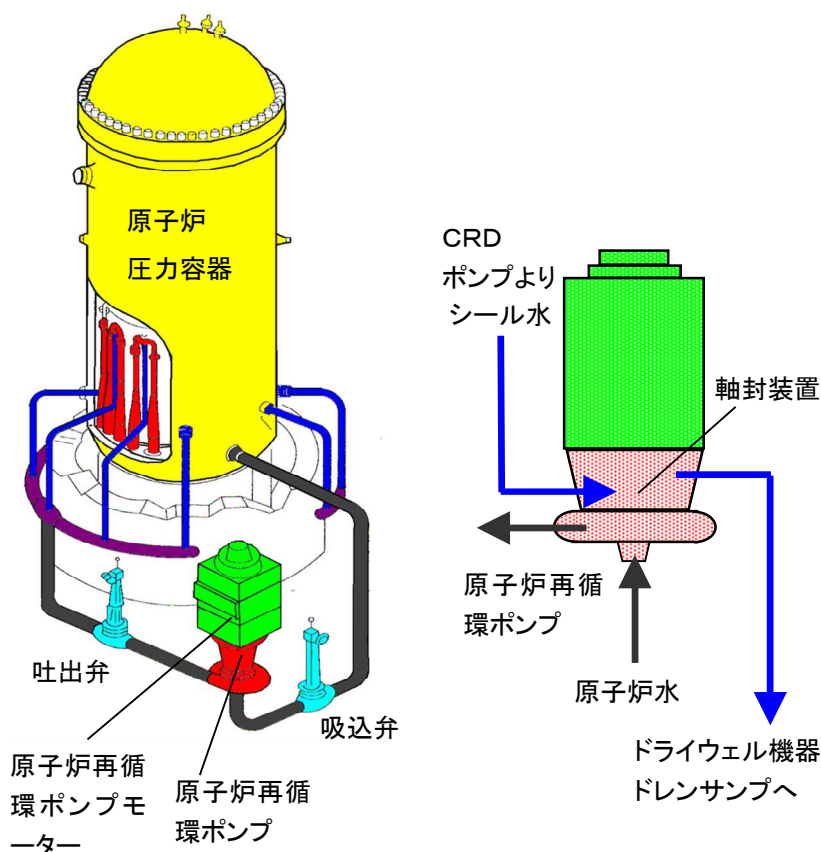

Figure Illustration of PLR pumps

[Back to List of Issues/Common](#)

Common/Issue-5	Common	Category B②	Class (1)	Safety measures in [1]: pp.42, 44
Core-concrete reactions				Results: -

At Unit-1, it is highly possible that molten fuel fell onto the PCV floor before continuous seawater injection to the reactor started at 19:04 on March 12th.

In a situation in which molten fuel is not sufficiently cooled, direct contact of molten fuel and concrete on the PCV floor heats up the concrete to above its melting point and the molten concrete and molten fuel dissolve into each other. The core-concrete reactions generate incondensable gases, such as hydrogen, carbon monoxide, etc. These influence the PCV pressure changes and the radioactive material release behaviors.

TEPCO presented the analysis results of core-concrete reactions at Unit-1, which was thought to have had the largest fraction of fallen fuel debris to the PCV, in the Technical Workshop on “Estimation of the damage status of reactor cores of Fukushima Daiichi Units-1 to 3” (organized by the former NISA and held on November 30th, 2011).

But the actual development of core-concrete reactions at Units-1 to 3 and its influence on the accident progression have a large uncertainty and still need to be clarified.

There is also a possibility of shell attacks which could open leak paths from the PCV by direct contact of molten fuel and PCV liners. However, no clear evidence has been observed to date which supports the occurrence of shell attacks: the pressures increased at Units-1 and 2 when nitrogen gas started to fill the PCV, while at Unit-3 the PCV water level was sufficiently high to have prevented them.

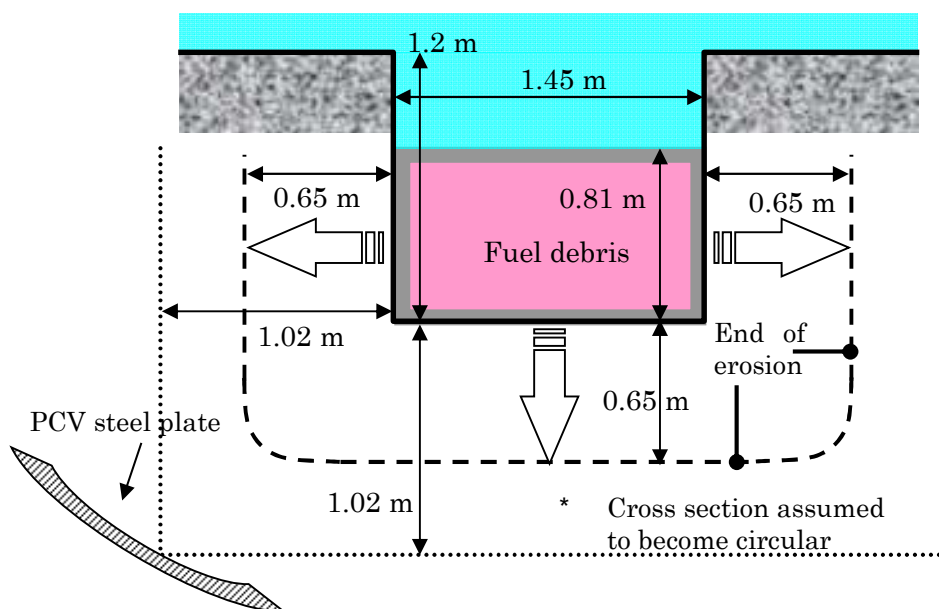

Figure Estimation of the scale of Unit-1 core-concrete reactions

[Back to List of Issues/Common](#)

Reference: Technical Workshop on “Estimation of the damage status of reactor cores of Fukushima Daiichi Units-1 to 3” (organized by the former NISA and held on November 30th, 2011).

<List of issues – Common ->

Common/Issue-6	Common	Category B②	Class (2)	Safety measures in [1] -
Molten core behavior on falling to the lower plenum				Results: Attachment 1-8
<p>MAAP employs basically Three Mile Island (TMI) knowledge in simulating the molten fuel relocation mechanism to the lower plenum, in which molten fuel destructs the core support plate and reaches the lower plenum. On the other hand, BWRs have complex lower structures, which could configure other molten fuel relocation paths to the lower plenum: via the coolant flow paths through a side entry orifice at the fuel support; or via the surrounding bypass region (whereto the molten fuel could migrate in the radial direction from the core) and, by damaging the shroud, further through the outer shroud region (downcomer region).</p> <p>In the MAAP analysis of Unit-1 to date, the reactor pressure showed a sharp peak at around 22:00 on March 11th. This comes from the model in the analysis that the molten fuel stayed temporarily on the core support plate for a while and, as soon as the core support plate was damaged, the molten fuel dropped instantaneously to the lower plenum, generating a large amount of hydrogen gas.</p> <p>It is necessary to clarify the molten fuel behavior during relocation to the lower plenum in order to contribute to understanding of the accident progression and estimation of the situation in the core and PCV.</p>				

<List of issues – Common ->

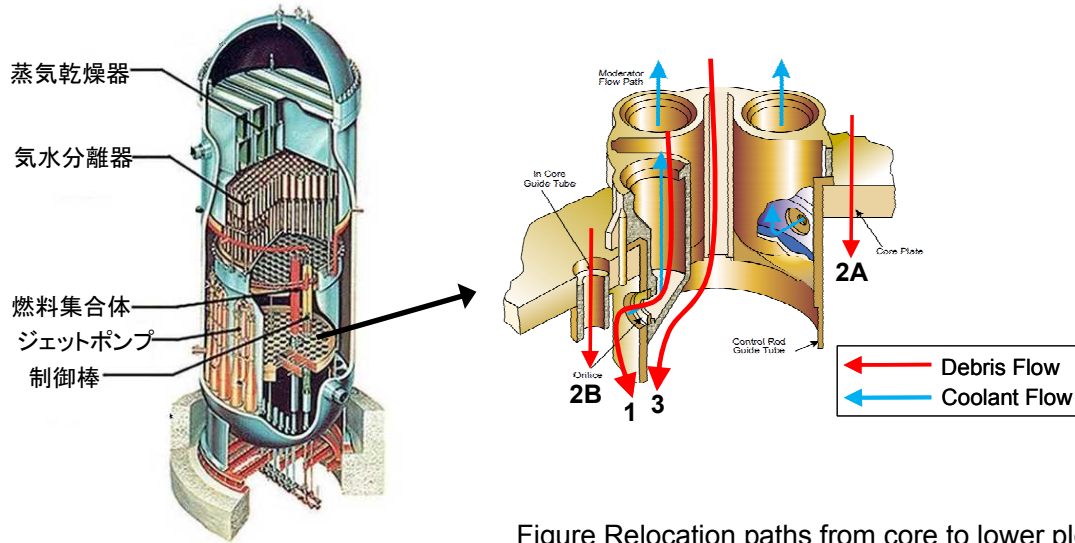
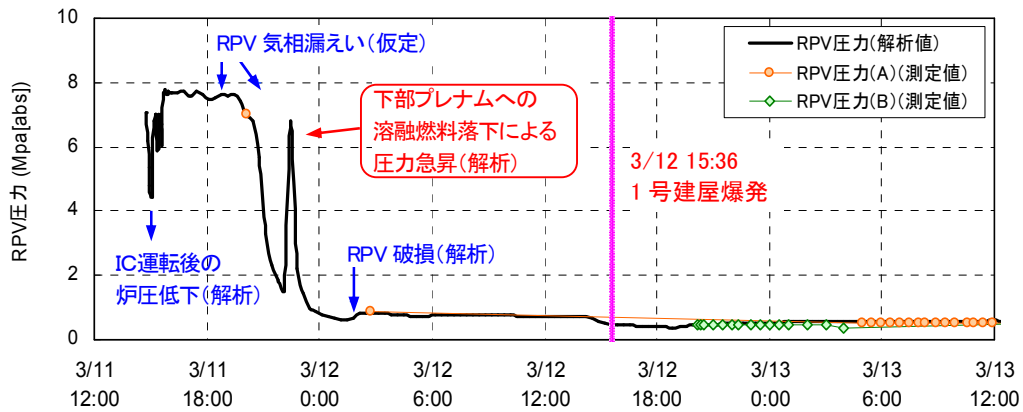

Figure Relocation paths from core to lower plenum



RPV 気相漏えい(仮定)	Gaseous leak from RPV (assumed)
下部プレナムへの溶融燃料落下による圧力急昇(解析)...	Sharp pressure increase due to debris slumping to lower plenum
IC運転後の炉圧低下(解析)	Pressure decrease after IC operation (anal.)
RPV 破損(解析)	RPV failure (anal.)
3/12 15:36 1号建屋爆発	At 15:36 March 12 th Unit-1 R/B exploded

Figure Reactor water level and PCV pressure changes in Unit-1

[Back to List of Issues/Common](#)

Common/Issue-7	Common	Category B⑤	Class (2)	Safety measures in [1]: -
Correlation between the timing of a large amount of radioactive materials released to the air and the monitoring car measurement				Results: -

Some of the radioactive materials released from the fuel during the accident progression were eventually released to the air via the PCV venting, the reactor building explosion, direct leaks from the PCV, etc. To date, TEPCO has been investigating the amount of radioactive materials released to the air per each main incident in the course of accident progression, and the reason of high contamination in the northwest area of the Fukushima Daiichi NPS. The investigations are based on the air dose rates observed by the monitoring cars and the meteorological data such as precipitation observed at a meteorological weather station

However, not every correlation is clear yet between the air dose rate changes measured on the site boundary measured by the monitoring cars, etc. and the radioactive materials release behavior from their origin. The air dose rates do not tell everything about the release situation from the origin of the radioactive materials but these rates provide information that is useful in interpreting the release conditions. The attenuation behavior of air dose rates may provide some information relevant to the contribution of deposits of radioactive materials released or their nuclear species.

In order to interpret the accident progression resulting in the release of radioactive materials, it is necessary to evaluate the air dose rate changes and the correlation of these rates with the timings, origin and paths of the radioactive materials released.

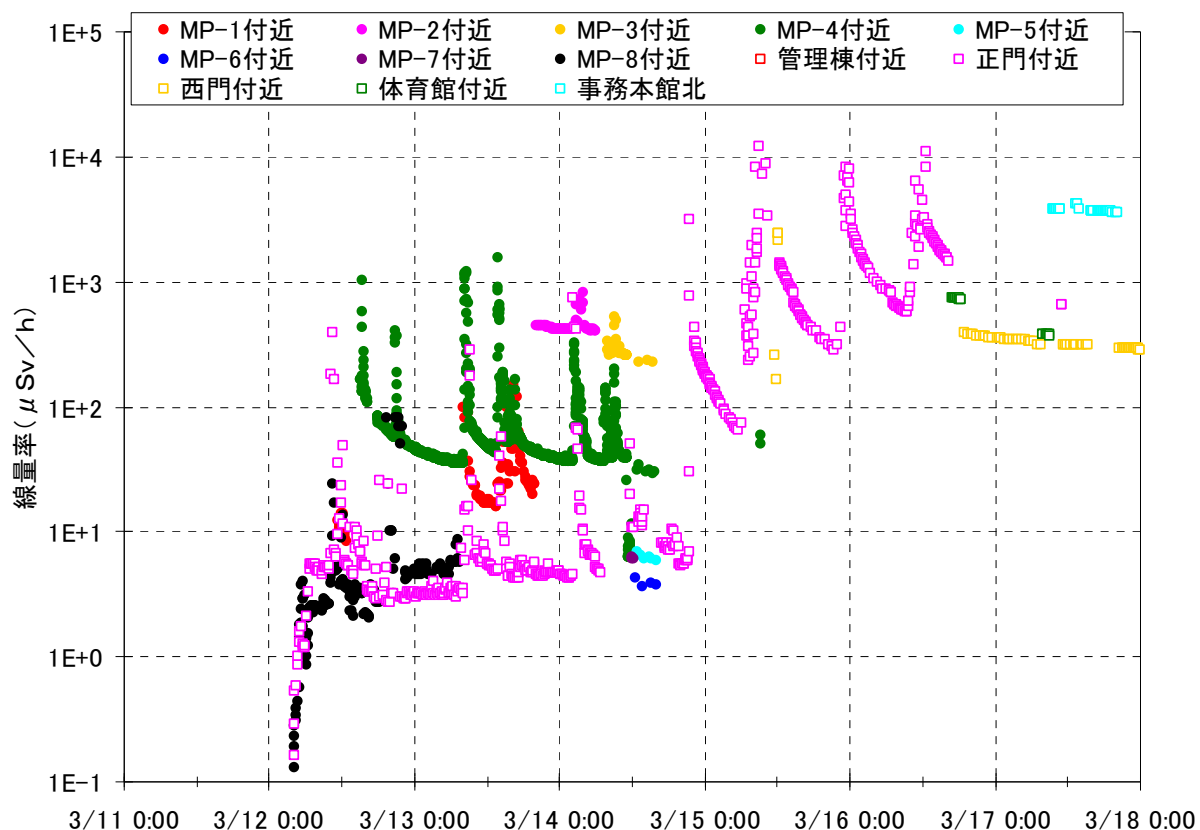

Figure Air dose rate changes on the site during March 11th to 18th.

[Back to List of Issues/Common](#)

Common/Issue-8	Common	Category B⑤	Class (2)	Safety measures in [1]: -
Radioactive materials release behavior at the time of PCV venting				Results: -

At Unit-1, three attempts were made from the MCR to open the small S/C vent valve, at 10:17, 10:23 and 10:24 on March 12th. No clear decrease was noticed in the D/W pressures, but the air dose rates near the main gate showed a short increase at 10:40. Thereafter, a temporary air compressor was connected to open the large S/C vent valve and it was activated at about 14:00 on the same day. Steam exhaust from the stack was observed on the live camera monitor and the D/W pressure showed a decrease through 14:30 to about 14:50. At this timing, no increase was noticed in the air dose rates measured by the monitoring car near the main gate (southwest) and near Monitoring Point 8 (south).

As seen in these incidents, the D/W pressures and the air dose rates at the monitoring car occasionally responded to the S/C vent valve operations, but occasionally they did not. This may indicate a possibility that a small release of radioactive materials through the small vent valve, not sufficient to cause noticeable D/W pressure changes, might have occurred, or a possibility that a direct release to the air from the reactor building might have occurred. The opening of the small vent valve causes only a small vent flow rate change and the D/W pressure decrease may be too limited to notice. It is necessary to clarify the radioactive materials release behavior in detail upon PCV venting by the small or large valve openings.

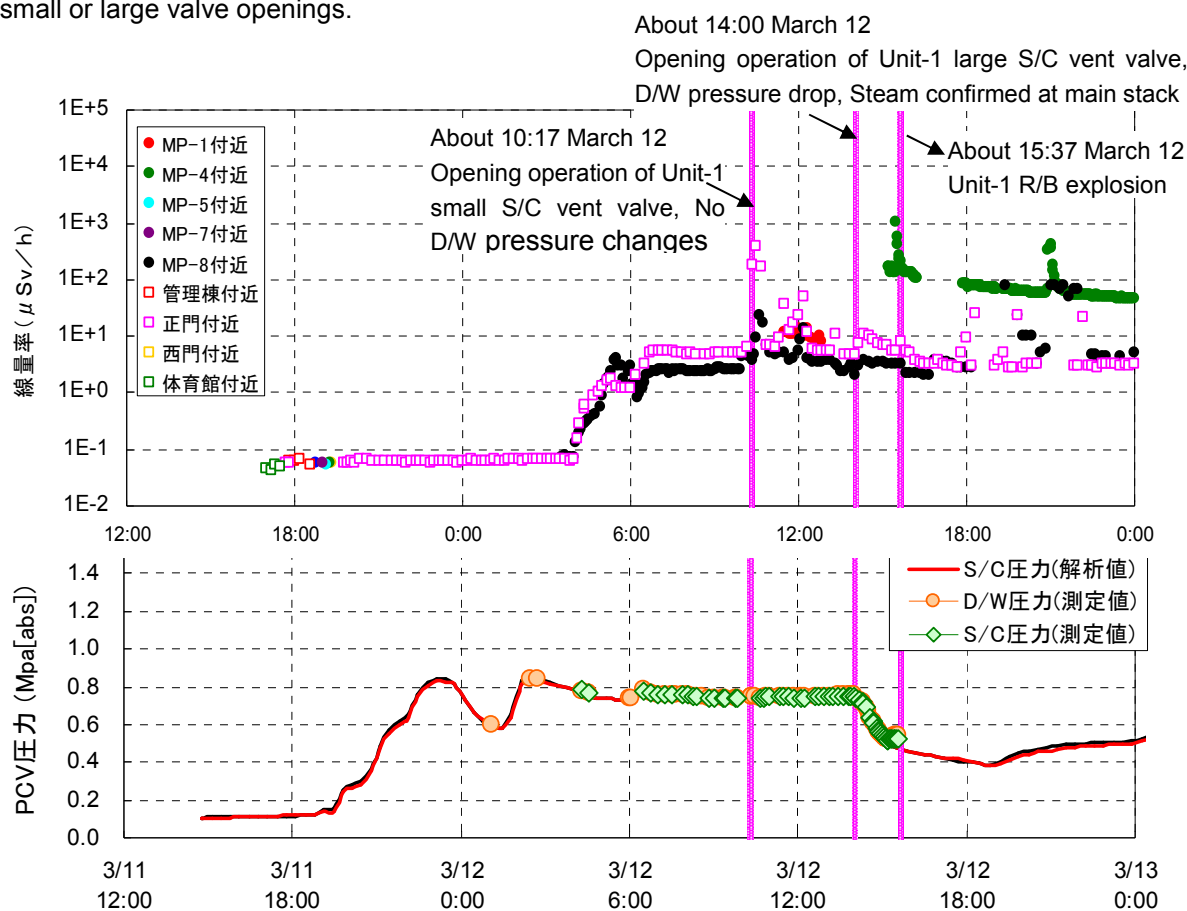

Figure Air dose rate changes from March 11th to 12th, and the changes of D/W and S/C pressures

[Back to List of Issues/Common](#)

<List of issues – Common ->

Common/Issue-9	Common	Category B⑤	Class (2)	Safety measures in [1]: -
Air dose increases on around March 20 th				Results: Attachment: 3-6
<p>At Unit-1 and Unit-3, the water injection rate observed on the Accident Management (AM) panel showed a big decrease from March 20th and 21st for several days. This may indicate that the reactor cooling was not sufficient to prevent the release of radioactive materials. Further, at about 16:00 on March 21st when black smoke rose at Unit-3, a sharp increase was observed in the air dose rate near the main gate, although no significant changes were noticed in the DW pressures and the RPV pressures.</p> <p>The analysis using MAAP is terminated in about a week at the maximum after the earthquake. This is because the uncertainties of the analysis become larger with the extended time of analysis and the reliabilities of the results are significantly lowered.</p> <p>Fission products released around March 20th and 21st from the Fukushima Daiichi NPS might have caused radiation dose increases in parts of the Kanto region, depending on the wind directions, and might have led to some recommendations to refrain from tap water intake due to increased radioiodine concentration levels. Details of radioactive materials release behavior need to be clarified.</p>				

<List of issues – Common ->

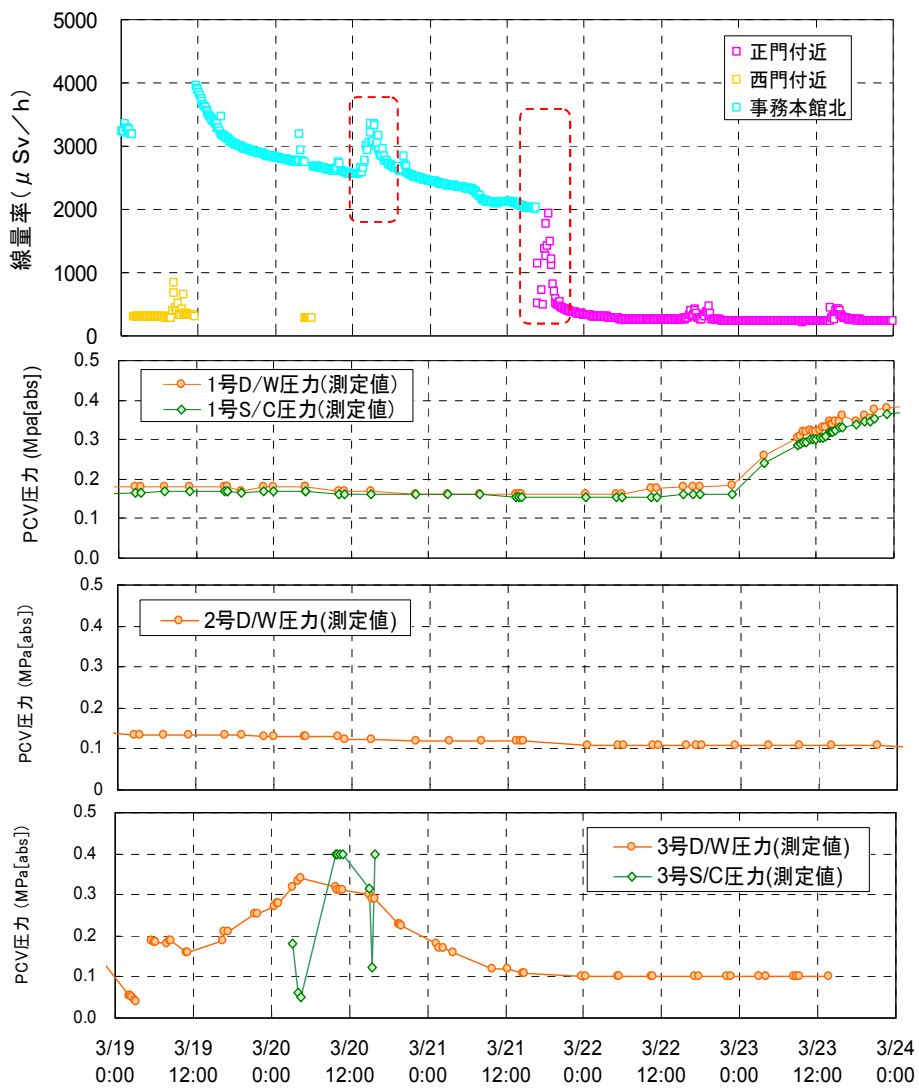

線量率	Dose rate
1号、2号、3号	Unit 1, unit 2, unit 3
压力(測定値)	Pressure(measurement)

Figure Air dose rates at the Fukushima Daiichi NPS from March 19th to 23rd

[Back to List of Issues/Common](#)

Common/Issue-10	Common	Category B⑤	Class (2)	Safety measures in [1]: -
Core damage and the location of core debris				Results: -

MAAP predicts that almost the whole Unit-1 core dropped to the RPV lower plenum and most of it fell further to the PCV pedestal, while the Unit-2 and Unit-3 cores remained in the core region, although there were partly molten fuel pools. Unit-1 lost all its existing water injection functions at an earlier stage and considerable time was taken to start water injection by fire engines. On the other hand, at Unit-2 and unit-3 the RCIC (Unit-2 and Unit-3) or HPCI (Unit-3) could continue injecting water to the reactor till a later stage. As a consequence, decay heat was lower when no more core cooling became possible by existing water injection means and less time was taken thereafter for the fire engines to start injecting water.

It should be noted, however, that MAAP analysis has uncertainties in setting its conditions, the analysis itself and the modeling. The results obtained have also uncertainties accordingly. MAAP predicts no RPV damage in Unit-2 and Unit-3, but the results depend greatly on the amounts of water injected to the reactor. As a matter of fact, the plant conditions thereafter indicate the reactor water levels were at very low levels and the RPVs are very likely to have been damaged. Further, core damage might have occurred even earlier at Unit-3 because the water injection by HPCI had been insufficient after the RPV pressure had decreased.

Currently, the location of debris, the ultimate result of the accident progression, is still unknown. It should be noted that the calculation results still have large uncertainties. Since this information is important input to decommission planning, further examinations are needed, based on the outcomes of the investigative research and development projects of the PCV and RPV, and other relevant projects.

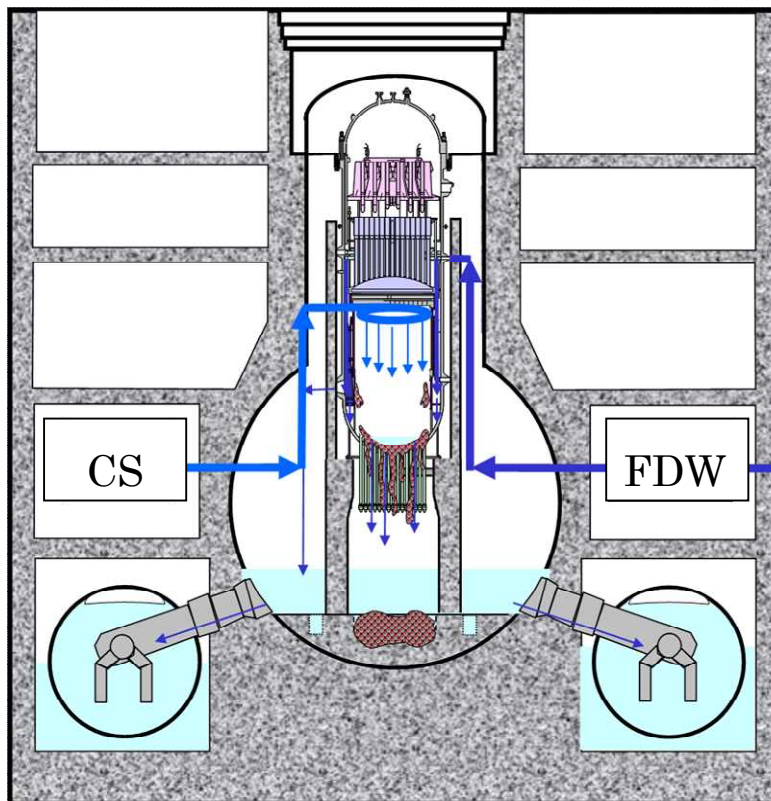

Figure Estimated conditions of the core and PCV of Unit-1

[Back to List of Issues/Common](#)

Common/Issue-11	Common	Category B⑥	Class (1)	Safety measures in [1]: pp.43 - 44
Reactor building hydrogen explosions				Results: -

At Unit-1, the D/W pressure decrease was confirmed from 14:30 through around 14:50 on March 12th following the large S/C vent valve opening operation. At 15:36 on that day, hydrogen exploded in this reactor building and the roof and the outer walls of the top floor were heavily damaged.

At Unit-3, the D/W pressure decrease was observed at 09:24 on March 13th, confirming the PCV venting. At 11:01 on March 14th, hydrogen exploded in this reactor building, damaging the top floor upward and the north-south outer wall of one floor below the top floor.

Further at about 06:14 on March 15th, hydrogen exploded in the Unit-4 reactor building. It is considered from later field inspections that the vented air of Unit-3 flowed into the Unit-4 reactor building, leading to the explosion, and there was a major pressure burst due to the explosion on the 4th floor.

These hydrogen explosions are considered to have been caused by hydrogen gas generated mainly by zirconium-water reactions which leaked out with steam to the reactor buildings. It is necessary to clarify the amounts of hydrogen gas generated and leak paths.

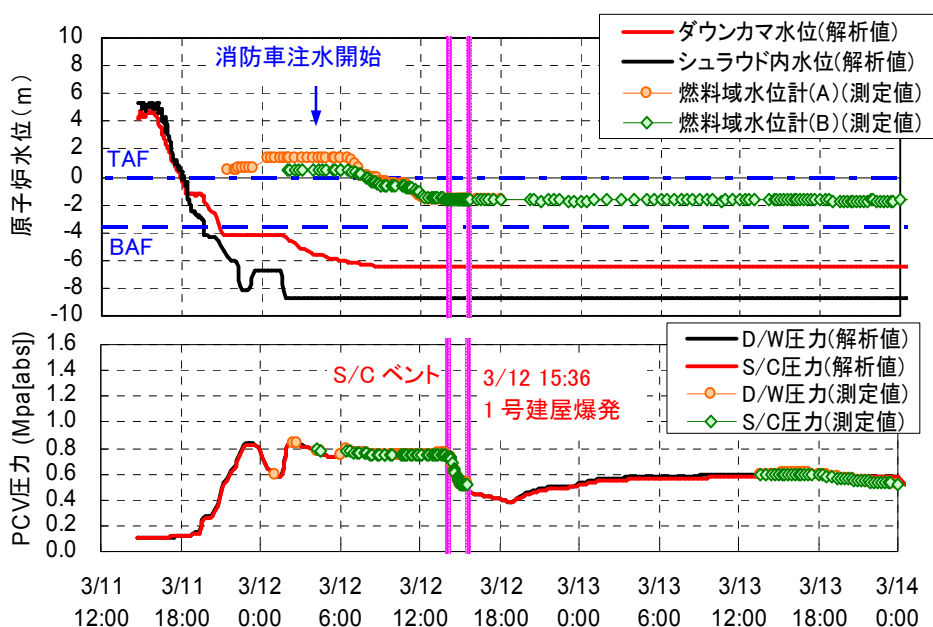

消防車注水開始	Water injection started by fire trucks
S/C ベント	S/C vented
3/12 15:36 1号建屋爆発	At 15:36 March 12 th Unit-1 R/B exploded

Figure RPV water level and PCV pressure changes at Unit-1 until the hydrogen explosion occurred

<List of issues – Common ->



Figure Unit-1 reactor building after the hydrogen explosion

[Back to List of Issues/Common](#)

<List of issues – Common ->

Common/Issue-12	Common	Category C①	Class (3)	Safety measures in [1]: pp.11-14 (measures against tsunami)
Knowledge about massive synchronized earthquakes with accompanying tsunami				Results: -
<p>It has been reported that the focal area of the Tohoku District Off-Pacific Ocean (Great East Japan) Earthquake extended from offshore Iwate Prefecture to offshore Ibaraki Prefecture, being about 500 km long, about 200 km wide, and with about 50 m in maximum slip. A massive slip was observed in the southern trench side off the Sanriku coast and part of the trench side off the Northern Sanriku coast to far south off the Boso Peninsula. Multiple regions, offshore Central Sanriku, offshore Miyagi Prefecture, offshore Fukushima Prefecture and offshore Ibaraki Prefecture, moved simultaneously in the hypocenterral region and the magnitude was 9.0 on the JMA scale.</p> <p>TEPCO also has conducted numerical simulations reproducing the tsunami, by setting a wave source model, which could well reproduce wave height marks, inundation heights, tide levels recorded, submerged areas, and diastrophism (specifically, the length, widths, depths, and locations of faults and slips, required for the numerical simulations). The results suggest a possibility that an especially big slip of a fault (about 50 m maximum) occurred near the Japan Trench.</p> <p>Many unknown matters remain about the causes of such massive synchronized earthquakes and massive tsunami. The research progress in Japan and overseas on their mechanisms will be monitored and the latest knowledge about them will be incorporated in the measures against massive earthquakes and tsunami.</p> <p align="right">Back to List of Issues/Common</p>				

<List of issues – Common ->

Common/Issue-13	Common	Category C①	Class (3)	Safety measures in [1]: -
Intensified seismic activities in the southern area of Hama-dori in Fukushima Prefecture				Results: -
<p>Seismic activities have become more intense in the southern area of Hama-dori in Fukushima Prefecture after the Tohoku District Off-Pacific Ocean (Great East Japan) Earthquake. A new fault appeared on the occasion of an earthquake on April 11th, 2011 as a normal fault in the Yunodake Fault, which TEPCO had assessed as having had no seismic activity since the Late Pleistocene era.</p> <p>Investigations in detail thereafter by trench surveys and other ways in Yunodake Fault revealed seismic activity marks at several locations since the Late Pleistocene era, resulting in the judgment that the Yunodake Fault had been a fault which should have been considered in seismic design. Should the investigations by boring or trenching have been done, the evaluation of the activities would have been possible [*]. This knowledge shows that fault activities should be directly confirmed by geographical investigations, for example trench surveys, in detail in order to exclude the effects of possible fault activities from the safety evaluation. This must be considered in future fault investigations.</p> <p>[*] Additional investigation report on Yunodake Fault, TEPCO, December 27, 2011 (in Japanese only) http://www.tepco.co.jp/cc/press/betu11_j/images/111227b.pdf</p> <p style="text-align: right;">Back to List of Issues/Common</p>				

<List of issues – Common ->

Common/Issue-14	Common	Category C①	Class (3)	Safety measures in [1]: pp.11 -14 (measures against tsunami)
Exact timing of the tsunami wave arrivals at major buildings of the Fukushima Daiichi NPS and their inundation routes				Results: Attachment Earthquake-tsunami-1

The tsunami waves which hit the Fukushima Daiichi NPS flooded not only the 4-m ground level above O.P. (O.P.: Onahama Port construction standard surface) (hereafter described as 4-m ground level), where seawater pumps had been installed, but also the 10-m ground level, where key buildings had been constructed. The tsunami waves also flowed into the buildings through openings and other routes. Consequently, motors and electrical equipment were flooded, and important systems such as emergency diesel generators and power panels were directly or indirectly affected and lost their functions.

The timings of arrival of tsunami waves to the station and their inundation routes will be continuously reviewed in order to clarify their correlation with the timings of loss of power supplies.

[Back to List of Issues/Common](#)

<List of issues – Common ->

Common/Issue-15	Common	Category C①	Class (3)	Safety measures in [1]: pp.11 -14 (measures against tsunami)
Impacts of tsunami wave forces				Results: -
<p>Concerning the wave forces of tsunami, damage was confirmed partially on doors, shutters, etc. installed on the openings at the ground level, which could be considered as being damaged directly by tsunami or by floating wreckage. Some of the heavy oil tanks, which had stood on the seaside area, seemed to have been pulled away by wave forces and buoyancy. But no significant damage was noticed on the building structures such as walls or pillars of key buildings. Furthermore, most of the breakwater and seawall banks stand as before, with no big impacts having been confirmed although part of the northern breakwater with a parapet was damaged. Actual wave forces due to tsunami on these building structures or breakwater and seawall banks were not measured, thus the situations at the time of the tsunami are difficult to grasp, but comparative studies referring to the actual damage will help to quantify the degree of conservative evaluation by using various wave force evaluation formulae (Goda Formula, Tanimoto Formula, etc.)</p> <p style="text-align: right;">Back to List of Issues/Common</p>				

<List of issues – Common ->

Common/Issue-16	Common	Category D	Class (3)	Safety measures in [1]: -
Investigation from the viewpoint of human factors				Results: -

In the MCRs for Units-1 to 4, most instrumentation and control power supplies were lost after the tsunami had arrived and nothing was available for operators to monitor plant conditions or to take operational actions.

There is also a reality, on the other hand, that operators in the MCRs were desperately struggling for any actions possible to take at that moment and situation, or later, by referring to, for example, system configuration diagrams. An example of such an attempt was that the operators in the Unit-1/2 MCR took an action around 17:00 on March 11th to prepare for water injection to the reactor via alternative water injection lines. It is important to verify the psychological conditions that operators and other personnel encountered under such situations in order to extract lessons for implementation to future development of emergency response, from the viewpoint of software.



Connecting employees' private car batteries to power necessary instrumentations



Photo of outer doors taken from indoors with no lights



Indicator readings being checked with a flashlight in total darkness

Figure Example photos of the site immediately after the earthquake and tsunami

[Back to List of Issues/Common](#)

<List of issues - Unit-1 >

Unit-1/Issue-1	Unit-1	Category A②	Class (1)	Safety measures in [1]: N.A.
Deterioration of IC heat removal performance due to hydrogen gas at Unit-1			Results: Attachment 1-7	

At Unit-1, the reactor pressure was being controlled after the earthquake by intermittent operation of the emergency isolation condensers (ICs). Immediately before all power supplies were lost due to the tsunami, the IC operation had been incidentally in a halted situation. In the station blackout condition, the shift operators in the MCR noticed the display lamps indicating the IC (Sub-system A) isolation valves (MO-2A, MO-3A) as “Closed” outside the PCV at around 18:00 on March 11th. They took opening action of the valves at 18:18 on March 11th, and confirmed the steam generating sounds and saw the steam when looking above the reactor building, but the amount of steam was limited and it stopped a while later. Concerned about the water inventory left in the IC shell side tank, at 18:25 the operators closed the isolation valve (MO-3A) on the return line.

It is considered that the non-condensable hydrogen gas generated by the water-zirconium reactions upon decrease of the reactor water level deteriorates the heat removal performance when it mixes in the IC cooling tubes. According to the analysis results, the reactor water level was slightly below TAF as of 18:18, and hydrogen gas might not have been being generated in large amounts. But hydrogen might have been generated by radiolysis as well. It is necessary to clarify how much the heat removal capability was actually deteriorated.

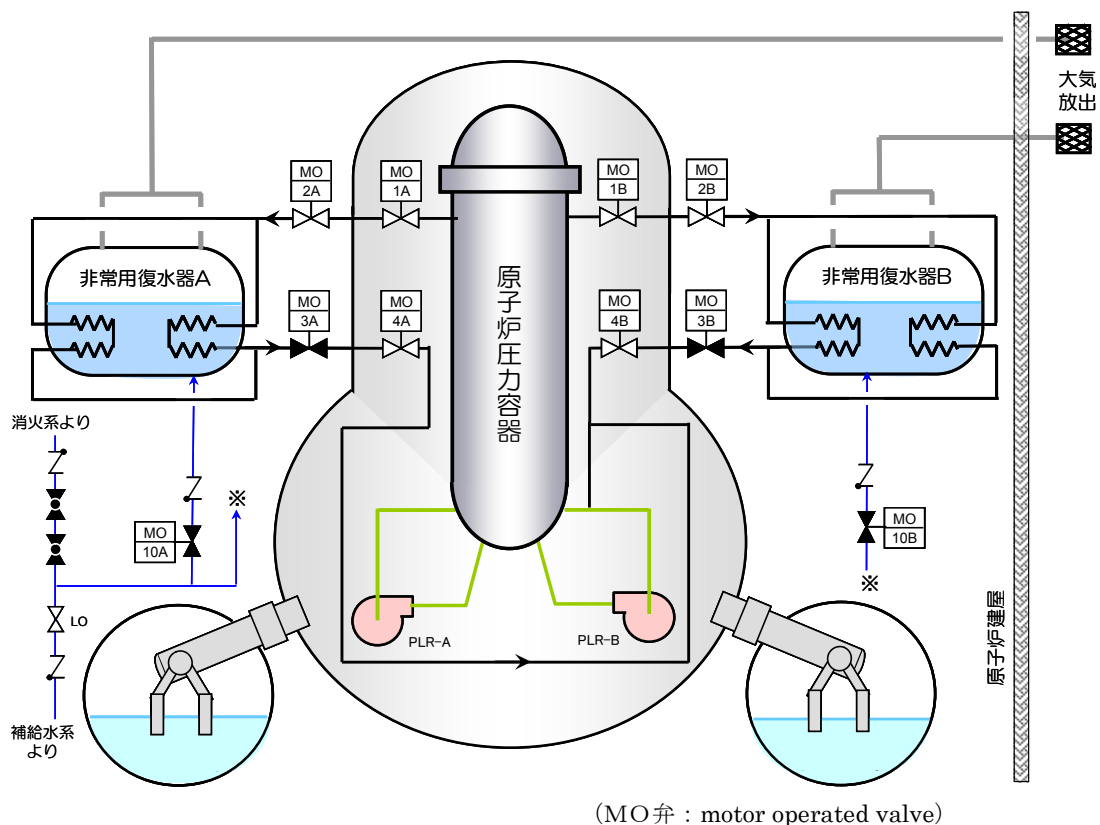

Figure Schematic illustration of IC systems

[Back to List of Issues/Unit-1](#)

<List of issues - Unit-1 >

Unit-1/Issue-2	Unit-1	Category A⑤	Class (2)	Safety measures in [1]:
Plant behavior if the Unit-1 ICs had functioned				Results: Attachment 1-7
<p>At Unit-1, the reactor pressure was being controlled after the earthquake by intermittent operation of the emergency isolation condensers (ICs). Immediately before all power supplies were lost due to tsunami, the IC operation had been incidentally in a halted situation. In the station blackout condition, the shift operators in the MCR noticed the display lamps indicating the IC (Sub-system A) isolation valves (MO-2A, MO-3A) as “Closed” outside the PCV at around 18:00 on March 11th. They took action to open the valves at 18:18 on March 11th, and confirmed the steam generating sounds and saw the steam when looking above the reactor building, but the amount of steam was limited and it stopped a while later. Concerned about the water inventory left in the IC shell side tank, at 18:25 the operators closed the isolation valve (MO-3A) on the return line.</p> <p>Post-accident surveys of the water level in the IC shell side tank showed that the water level of Sub-system A had been 65% (normal level was 80%) and the water in the tank had been sufficient. If the isolation valve (MO-3A) on the return line had not been closed at 18:25 on March 11th, the reactor cooling by the IC might have been continued.</p> <p>Therefore, the reason why the amount of steam generation was limited upon the opening of the IC Sub-system A isolation valves outside the PCV and why it stopped after a while (Unit-1/Issue-1) will be investigated. In addition the effect on the accident progression will be investigated, if the isolation valve of IC (Sub-system A) outside the PCV had been kept open after 18:25 on March 11th.</p>				

<List of issues - Unit-1 >

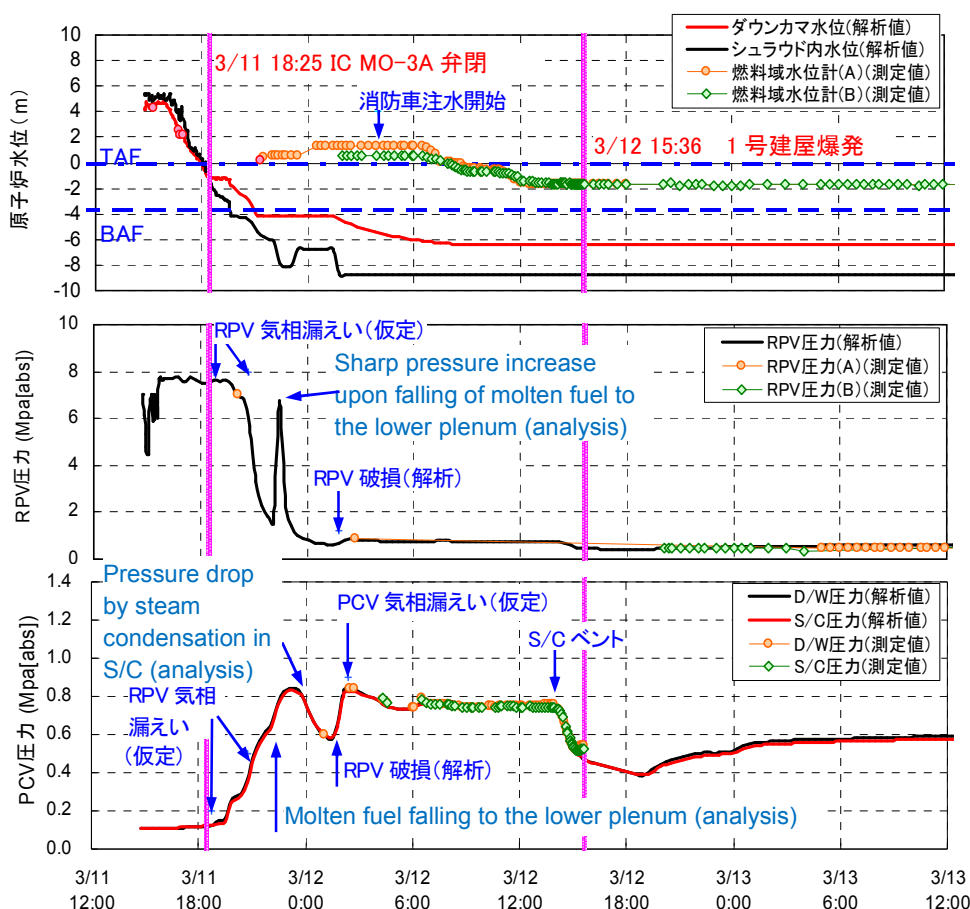

3/11 18:25 IC MO-3A 弁閉	At 18:25 March 11 th MO-3A opened
消防車注水開始	Water injection started by fire truck
3/12 15:36 1号建屋爆発	At 15:36 March 12 th Unit-1 R/B exploded
RPV 気相漏えい(仮定)	Gaseous leak from RPV (assumed)
下部プレナムへの溶融燃料落下による圧力急昇(解析)	Sharp pressure increase upon slumping of molten fuel to the lower plenum (analysis)
RPV 破損(解析)	RPV failure (anal.)
S/Cでの蒸気凝縮による圧力低下(解析)	Pressure decrease by steam condensation in S/C (analysis)
PCV 気相漏えい(仮定)	Gaseous leak from PCV (assumed)
RPV 破損(解析)	RPV failure (anal.)
下部プレナムへの溶融燃料落下(解析)	Molten fuel slumping to the lower plenum (analysis)
S/C ベント	S/C vented

Figure Changes of Unit-1RPV water level, RPV pressure and PCV pressures

[Back to List of Issues/Unit-1](#)

<List of issues - Unit-1 >

Unit-1/Issue-3	Unit-1	Category A⑤	Class (2)	Safety measures in [1]:
RPV water level indicator readings at Unit-3 after loss of true value indications				Results: Attachment 1-6

At Unit-1, all power supplies were lost due to the tsunami and it became impossible to measure the reactor water level. When the fuel range water level indicators were restored by the temporary battery supply at 21:19 on March 11th, the water level indicator reading was at +200mm above the top of active fuel (TAF). Thereafter, the water level indicators showed an increase, despite no water injection to the reactor.

The fuel range water level indicators of the condensing water chamber type cannot show true values when the PCV temperature rises or the reactor pressure decreases, because the water in the piping in the condensation chamber evaporates. Therefore, the fuel range reactor water level indicators seem to have been already malfunctioning when restored by the temporary power supply.

But the water levels indicator readings tell the pressure difference between the reference leg and variable leg. It is possible that some information might be obtained on the reactor depressurization timings or reactor water levels.

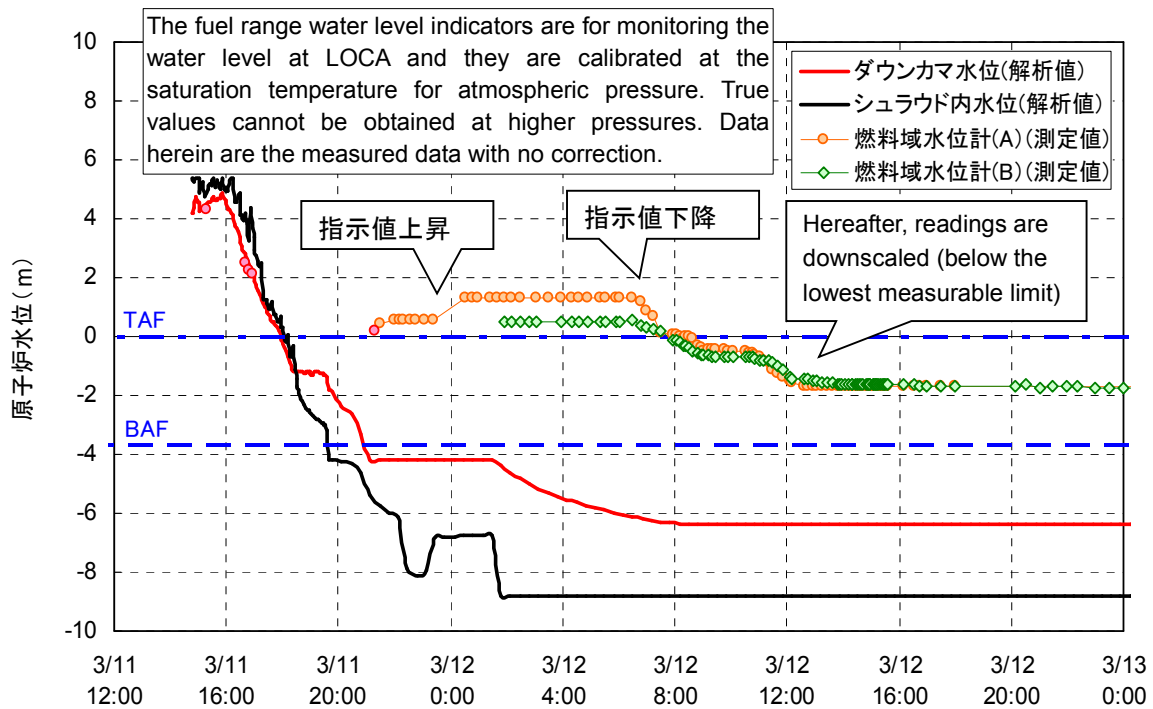

指示値上昇	Readings up
指示値下降	Readings down

Figure Reactor water level changes at Unit-1

[Back to List of Issues/Unit-1](#)

<List of issues - Unit-1 >

Unit-1/Issue-4	Unit-1	Category A⑥	Class (2)	Safety measures in [1]: -
LOCA possibility at Unit-1 due to the earthquake				Results: Attachment 1-3
<p>At Units-1 to 3 of the Fukushima Daiichi NPS, after the reactor scrams due to the earthquake, operational procedures were ongoing towards cold shutdown by startup of the reactor cooling functions. But the tsunami caused the station blackout including the loss of DC power supplies. As the power supplies were unable to be restored in a short period, all reactor cooling functions were lost. This is considered to be the reason for the severe accident in these units. In other words, the direct reason for the severe accident is considered to be the tsunami.</p> <p>However, the Fukushima Nuclear Accident Independent Investigation Commission of the National Diet of Japan (hereinafter referred to as the “Diet Investigation Commission”) pointed out in its report that a possibility could not be negated of a small loss of coolant accident (LOCA) at Unit-1. The Diet Investigation Commission’s grounds for alleging this possibility were the following three points:</p> <ul style="list-style-type: none">• Contractor workers noticed water dripping in the IC room on the 4th floor of the reactor building;• The Japan Nuclear Energy Safety Organization (JNES) report did not negate leaks from a hole below 0.3cm²; and• Shift operators did not hear the sounds of the main steam safety relief valves (SRVs) working. <p>An examination will be conducted to check logically, starting with these three points, whether such a LOCA could have happened.</p> <p>The Diet Investigation Commission’s report also pointed out a possibility that the emergency diesel generator (A) (DG (A)) might have lost its function, not due to the tsunami, but due to the earthquake, based on the statement of a shift operator that the DG (A) might have lost its function before arrival of the tsunami.</p> <p>In April 2013 it was reconfirmed that the transient recorder had kept the data, including the one-minute-cycle information, from before the earthquake until the transient recorder stopped due to the tsunami. This newly found set of data will be used for examining the DG (A) behavior.</p> <p style="text-align: right;">Back to List of Issues/Unit-1</p>				

<List of issues - Unit-1 >

Unit-1/Issue-5	Unit-1	Category B③	Class (2)	Safety measures in [1]: pp27-36
Leaks in gaseous phase from Unit-1 RPV				Results: -
<p>At Unit-1, the RPV pressure measured 7.0MPa[abs] at 20:07 and the D/W pressure measured 0.6MPa[abs] at about 23:50 on March 11th, while the D/W pressure was 0.84MPa[abs] at 02:30 and the RPV pressure was 0.9MPa[abs] at 02:45 on March 12th. Although the exact timings are unclear, it was confirmed that the PCV pressure showed a big increase. And the RPV pressure decreased despite no depressurization operation.</p> <p>If the reactor water level drops and the core starts to be uncovered, the heat transfer from the overheated core and the overheated steam heat up the RPV pressure boundary above its normal temperatures. There may be a possibility that leak holes form for leaks in the gaseous phase at some of these upper locations before the molten fuel penetrates the RPV bottom, and the RPV pressure may decrease if the leak holes are big enough. Should that have occurred, it would affect the timings of RPV damage and the thermal and mechanical loads to the PCV after the RPV damage.</p> <p>The MAAP analysis assumed that the core temperatures were elevated by the overheating of the uncovered core and molten fuel, resulting in gaseous leaks from the RPV to the D/W through the in-core instrumentation dry tubes or the SRV flanges on the main steam line.</p> <p>But there is no direct evidence of measured plant parameters or observations that confirms leaks through these leak paths. Clarification is needed for grasping the core and PCV conditions.</p>				

<List of issues - Unit-1 >

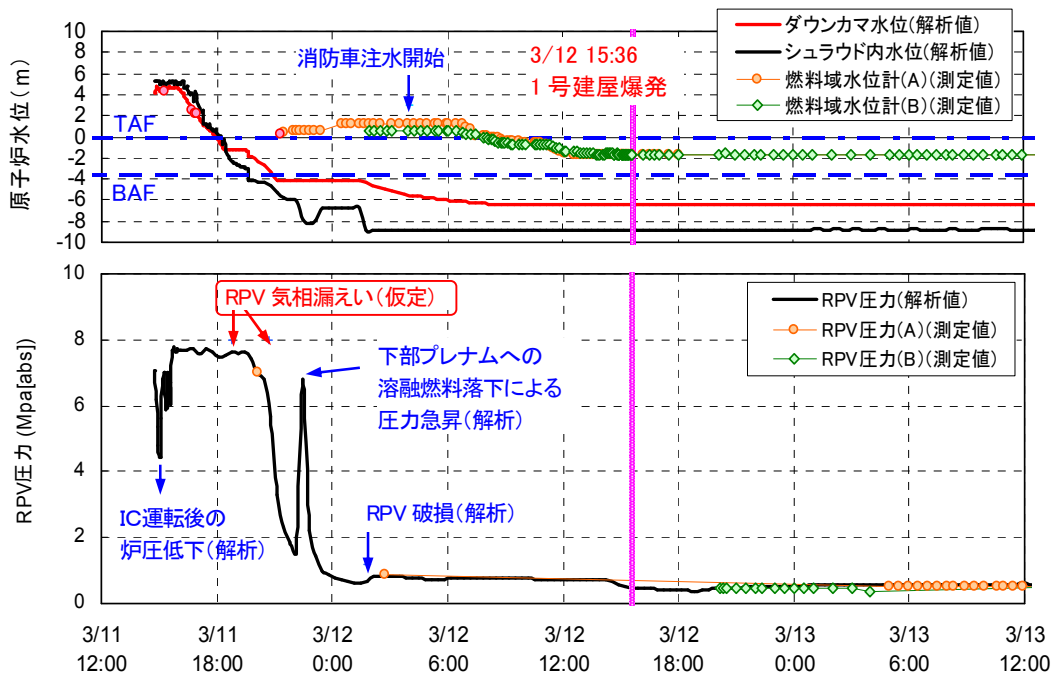

消防車注水開始	Water injection started by fire truck
3/12 15:36 1号建屋爆発	At 15:36 March 12 th Unit-1 R/B exploded
RPV 気相漏えい(仮定)	Gaseous leak from RPV (assumed)
下部プレナムへの溶融燃料落下による圧力急昇(解析)	Sharp pressure increase due to debris slumping to lower plenum
IC運転後の炉圧低下(解析)	Pressure decrease after IC operation (anal.)
RPV 破損(解析)	RPV failure (anal.)

Figure RPV and PCV pressure changes at Unit-1

[Back to List of Issues/Unit-1](#)

<List of issues - Unit-1 >

Unit-1/Issue-6	Unit-1	Category B④	Class (1)	Safety measures in [1]: pp.27-43
Leaks in gaseous phase from Unit-1 PCV				Results: -
<p>The Unit-1 DW pressure measured 0.6MPa[abs] at about 23:50 on March 11th, 0.84MPa[abs] at about 02:30 on March 12th and then stayed between 0.7MPa[abs] and 0.8MPa[abs] until it decreased at about 14:30 by the venting operation.</p> <p>Steam generation by water injection, the PCV temperature increases, the gas production by core-concrete reactions, etc. are likely to increase the PCV pressures. Nevertheless, it remained at a level which may indicate possible leaks from the PCV.</p> <p>In the meantime, shift operators entered the reactor building at about 21:00 on March 11th, when their APDs measured 0.8mSv instantaneously. They reported it upon return to the MCR at 21:51. At about 04:00 on March 12th and onward, the dose rates increased in wide areas near the main gate.</p> <p>The MAAP analysis assumed gaseous leaks from the PCV to the reactor building at about 03:10 on March 12th, about 12 hours after the earthquake. It was so assumed to roughly simulate the measured PCV pressure changes. But there is no direct evidence of measured plant parameters or observations that confirms the timing of leaks and their paths.</p> <p>Clarification is needed for grasping the PCV conditions.</p>				

<List of issues - Unit-1 >

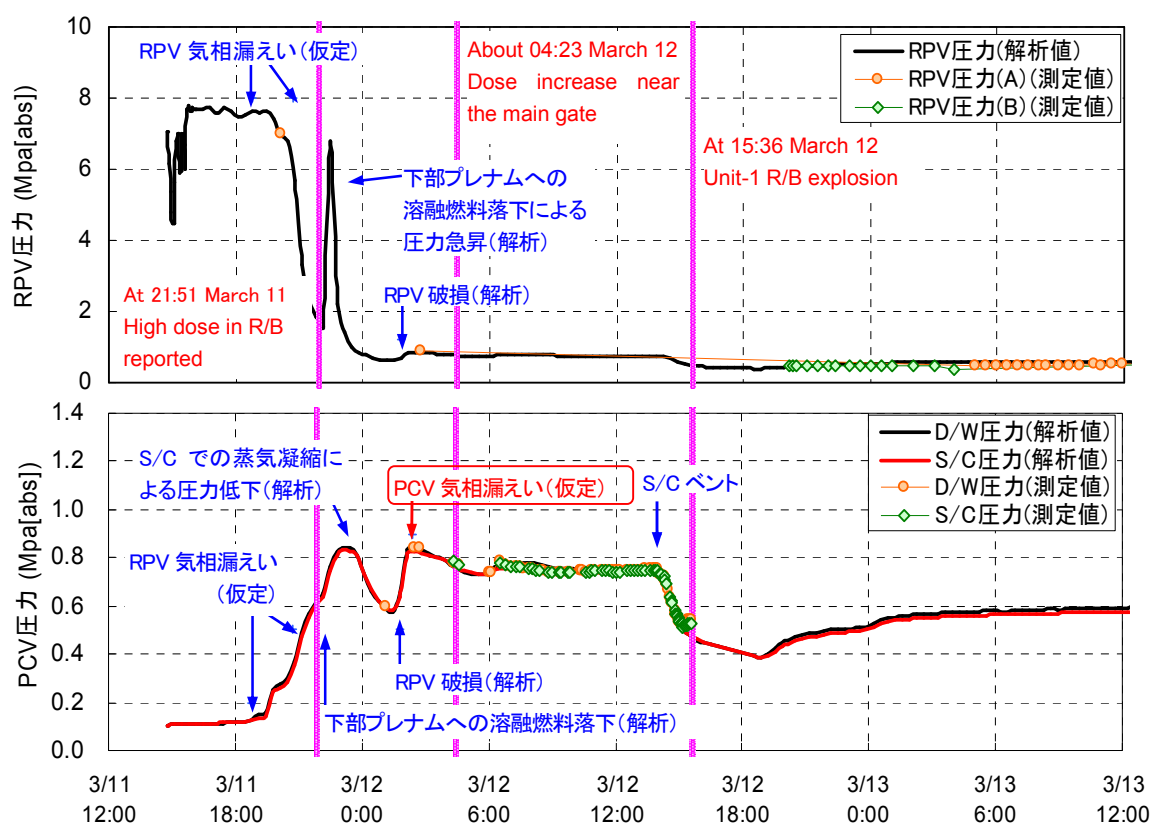

RPV 気相漏えい(仮定)	Gaseous leak from RPV (assumed)
3/11 21:51 原子炉建屋内高線量報告	At 21:51 March 11 st High dose in R/B reported
3/12 4:23 頃 正門付近線量上昇	About 04:23 March 12 th Dose increase near the main gate
下部プレナムへの熔融燃料落下による圧力急昇(解析)	Sharp pressure increase due to debris slumping to lower plenum
RPV 破損(解析)	RPV failure (anal.)
3/12 15:36 1号建屋爆発	At 15:36 March 12 th Unit-1 R/B exploded
S/Cでの蒸気凝縮による圧力低下(解析)	Pressure decrease by S/C steam condensation
RPV 気相漏えい(仮定)	Gaseous leak from RPV (assumed)
PCV 気相漏えい(仮定)	Gaseous leak from PCV (assumed)
RPV 破損(解析)	RPV failure (anal.)
下部プレナムへの熔融燃料落下(解析)	Molten fuel slumping to lower plenum (anal.)
S/C ベント	S/C vented

Figure RPV and PCV pressure changes at Unit-1

[Back to List of Issues/Unit-1](#)

<List of issues - Unit-1 >

Unit-1/Issue-7	Unit-1	Category B⑤	Class (2)	Safety measures in [1]: pp.27-36 (strengthening of water injection means)
Dose rate increase in Unit-1 reactor building on March 11 th				Results: -
<p>At 17:19 on March 11th, shift operators approached the Unit-1 reactor building, carrying a GM survey meter for contamination inspections, in order to check the RPV pressure indicators and the IC shell side remaining water levels. When they opened an outer airlock door, their GM survey meter gave a value higher than normal (recording 300cpm, about three time the usual background). They returned to the MCR to report this at 17:50.</p> <p>There is a further record that at about 21:00 on March 11th, when shift operators entered the reactor building, their APDs measured 0.8mSv instantaneously and they reported it upon return to the MCR at 21:51.</p> <p>By referring to the written records on the MCR whiteboard for consideration, the dose rate at the spot could be 288mSv/h, <i>if</i> "instantaneously" were assumed as 10 seconds. When compared to the dose limit 100mSv for emergency operations, this dose rate (288mSv/h) is high enough to impede the accident management operations.</p> <p>It is not clear whether the dose rates in the reactor building were high, when shift operators entered the reactor building at 20:07 on March 11th to check the RPV pressure indicators. It has been confirmed that, later at 23:00, the dose rates before the airlock doors of the reactor building were high (1.2mSv/h in front of the outside of the north airlock door, and 0.52mSv/h in front of the outside of the south airlock door).</p> <p>Thus, the high dose rates are recognized at an early stage of the accident at Unit-1, but there is no direct evidence which shows the exact timings and paths of fission product leaks. It is necessary to clarify them, in combination with the Unit-1/issue-8 and 9, in order to assess the accessibility to the reactor building for accident management operations as well as to estimate the conditions of the core and the PCV.</p>				

<List of issues - Unit-1 >

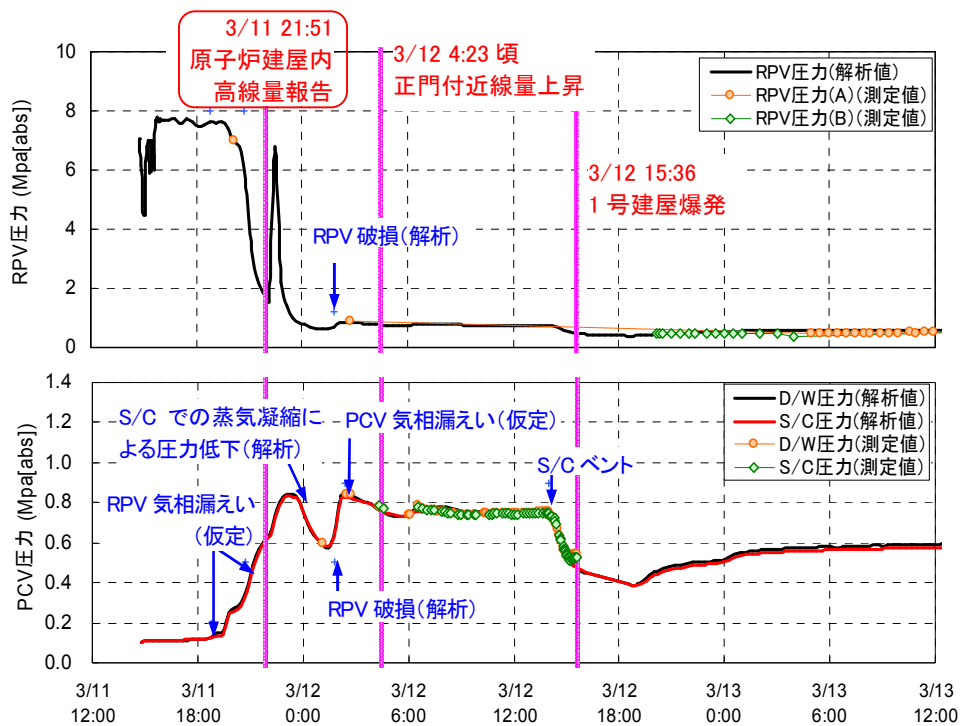

3/11 21:51 原子炉建屋内高線量報告	At 21:51 March 11 st High dose in R/B reported
3/12 4:23 頃 正門付近線量上昇	About 04:23 March 12 th Dose increase near the main gate
RPV 破損(解析)	RPV failure (anal.)
PCV 気相漏えい(仮定)	Gaseous leak from PCV (assumed)
S/C ベント	S/C vented

Figure RPV and PCV pressure changes at Unit-1

[Back to List of Issues/Unit-1](#)

<List of issues - Unit-1 >

Unit-1/Issue-8	Unit-1	Category B⑤	Class (2)	Safety measures in [1]: pp.40, 43, 44 (strengthening of venting means)
Causes of high contamination in the southeast area of the ground floor in the Unit-1 reactor building				Results: -

The investigations in May, June and October of 2011, and in July of 2012 located high dose rate areas of several thousand mSv/h in the southeast area of Unit-1 reactor building. In the June 2011 investigation, steam was also confirmed to be blowing out from a penetration of the floor in the area. In the July 2012 investigation, a robot attempted but failed to unlock the traveling in-core probe (TIP) room door in the area. The inside of the TIP room has not been investigated yet.

The high dose rate in the southeast area of the reactor building ground floor may be related to the steam blown from the floor penetration of the S/C venting line or possible damage of the TIP dry tubes due to the uncovered and overheated core. The causes of the high contamination are to be investigated.

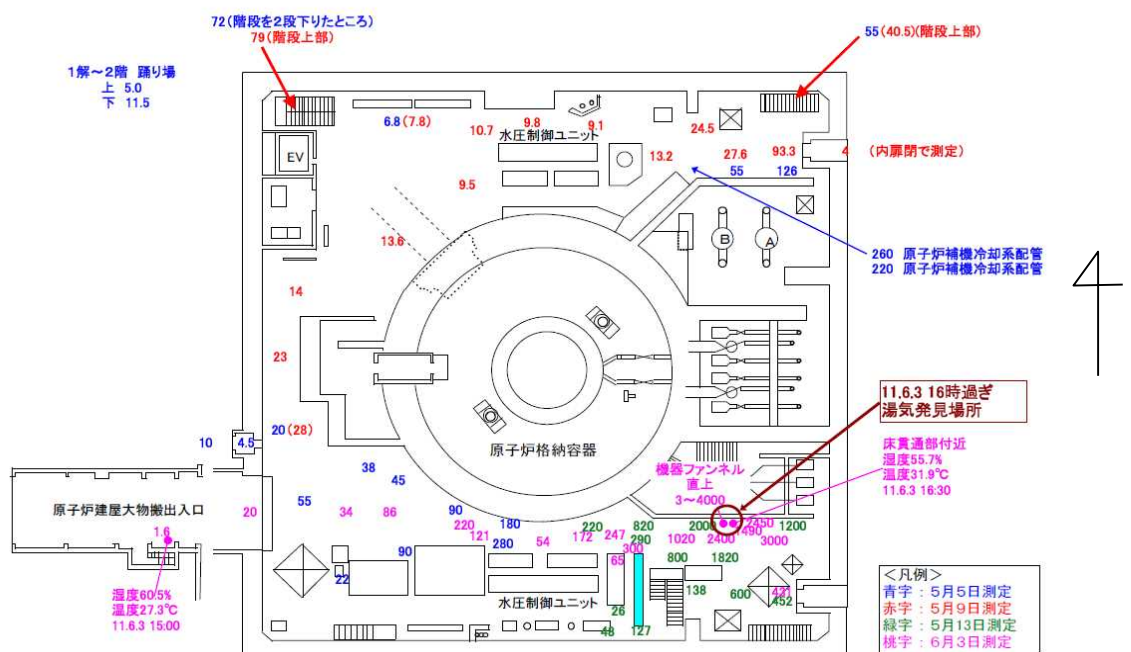

測定点	1	2	3	4	5	6	7	8	9	10	11	12	13
床上150cm	254	321	132	1900	881	290							
床上15cm	238	251	77	840	406	254	93※1	55※1	34※1	40※1	102※1	132※1	57※1
測定点	14	15	16	17	18	19	20	21	22	23	24	25	
床上150cm		1110	1620	1050	345	538						130※2	
床上15cm	109※1	528	777	520	311	474	2070※3	5150※4	85※1	96※1	168※1		

※1 床上約60cm ※2 床上106cm ※3 ファンネル上部 ※4 床貫通部上部
 ※5 斜線については干渉物等により測定できなかった箇所

Figure Dose rates measured in the reactor building (Handouts on June 4, 2011 (top) and on July 5, 2012 (bottom)) [Back to List of Issues/Unit-1](#)

<List of issues - Unit-1 >

Unit-1/Issue-9	Unit-1	Category B⑤	Class (2)	Safety measures in [1]: pp.40, 43, 44 (strengthening of venting means)
Causes of high dose contamination around the Unit-1 RCW piping			Results: Attachment 1-9	
<p>The investigation of Unit-1 in May 2011 confirmed high dose rate contamination of several hundred to several thousand mSv/h near the RCW piping. No such high dose rate has been noticed near the RCW piping at Unit-2 and Unit-3.</p> <p>The RCW is a closed-loop system to cool auxiliary equipment and is unlikely to experience such high contamination in normal situations. However, the RCW also has a role to cool the equipment inside the PCV and it has piping to cool the drain in the equipment drain sump at the bottom of the pedestal.</p> <p>Therefore, there may be a possibility that part of the molten fuel fell into the equipment drain sump and damaged the RCW piping, allowing the transfer of high dose rate steam or water containing radioactive materials into the RCW piping. Identification of the causes of high dose rates in the RCW piping may help to estimate the conditions of the core and the PCV.</p>				

<List of issues - Unit-1 >

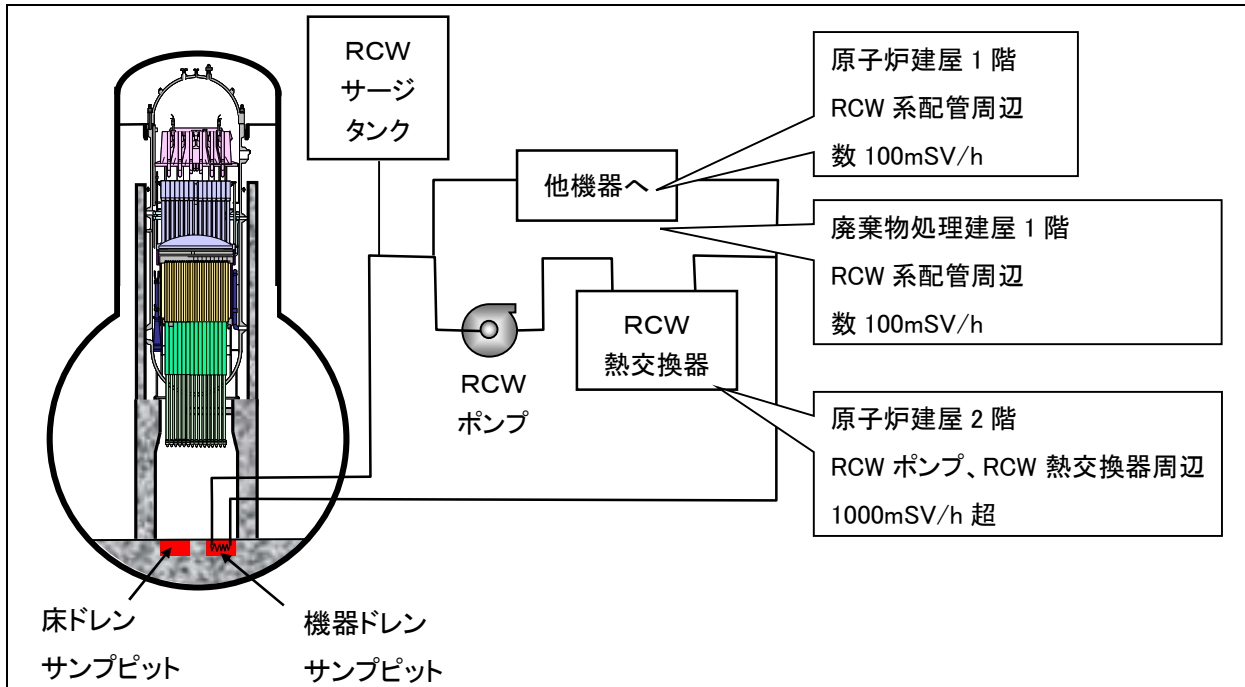

RCWサージタンク	RCW surge tank
他機器へ	To other systems/equipment
RCW熱交換器	RCW heat exchanger
RCWポンプ	RCW pump
原子炉建屋 1 階 RCW 系配管周辺数 100mSV/h	R/B first floor Several hundred mSv/h around RCW piping
廃棄物処理建屋 1 階 RCW 系配管周辺数 100mSV/h	RW/B first floor Several hundred mSv/h around RCW piping
原子炉建屋 2 階 RCW ポンプ、RCW 熱交換器周辺 1000mSV/h 超	R/B 2nd floor More than several hundred mSv/h around RCW pump and heat exchanger
床ドレンサンプピット	Floor drain sump pit
機器ドレンサンプピット	Equipment drain sump pit

Figure Schematic diagram of RCW system

[Back to List of Issues/Unit-1](#)

<List of issues - Unit-1 >

Unit-1/Issue-10	Unit-1	Category B⑤	Class (2)	Safety measures in [1]: -
High dose rate contamination near the Unit-1 SGTS piping				Results: -

The investigation in July and August 2011 confirmed high dose rates of 10Sv/h near the stand-by gas treatment system (SGTS) piping of Unit-1 connected to the Unit-1/2 main stack. The investigation in August 2011 also confirmed a high dose rate of several Sv/h when accessing the entrance of the SGTS train room. On the other hand, the investigation of Unit-3 in December 2011 confirmed the dose rate of several mSv/h in the SGTS filter train. At Unit-2, a high dose rate of 600mSv/h was measured in the SGTS train room, although no detailed measurements were made of the SGTS filter train itself (updated: See attachment 4).

The high dose rates near the SGTS piping can be considered to be caused by the deposited radioactive materials which were released from the damaged core. The detailed causes of the contamination are to be clarified.



撮影場所：1・2号機主排気筒付近
 撮影日時：平成23年7月31日 16時頃
 撮影者：東京電力株式会社

福島第一原子力発電所1号機タービン建屋2階 高線量検出箇所

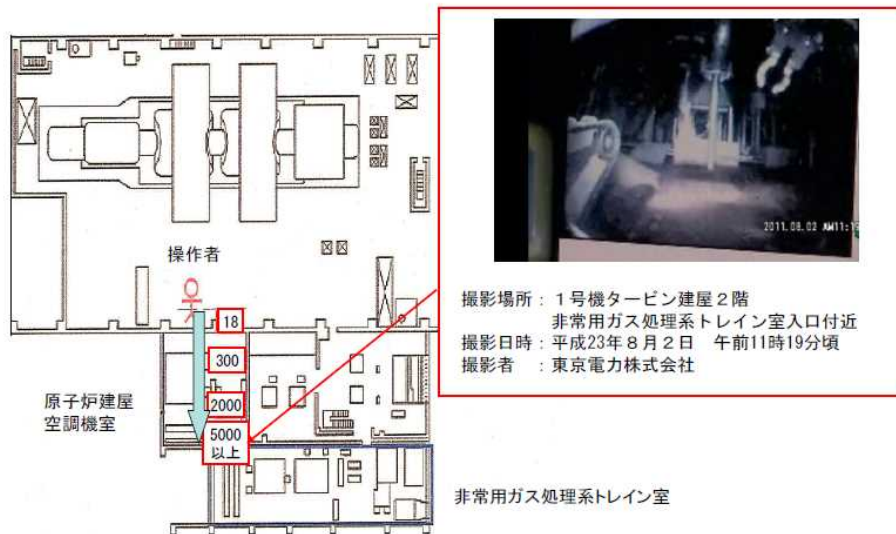

撮影場所：1号機タービン建屋2階
 非常用ガス処理系トレイン室入口付近
 撮影日時：平成23年8月2日 午前11時19分頃
 撮影者：東京電力株式会社

Figure Measured dose rates (Handouts on August 2nd, 2011 (top) and on August 3rd, 2011 (bottom))

<List of issues - Unit-1 >

Unit-1/Issue-11	Unit-1	Category B⑦	Class (2)	Safety measures in [1]: -
Impacts of water injection interruptions on the accident progression				Results: Attachment 3

The amount of water injected by fire engines to Unit-1 was set for the Unit-1 MAAP analysis, based on the latest available information at the time of analysis. It was noticed, however, in the investigations thereafter that water injection had been halted from 21:45 to 23:50 on March 12th and from 01:10 to 20:00 on March 14th.

The impacts of water injection interruptions on the accident progression are to be examined.

[Back to List of Issues/Unit-1](#)

Unit-2/Issue-1	Unit-2	Category: A②	Class (1)	Safety measures in [1]: p.20,29
RCIC flow rates after loss of DC power supply for control at Unit-2				Results: Attachment 2-4

At Unit-2, the RCIC repeated manual startups and automatic shutdowns due to the high reactor water level signal after the earthquake. Immediately after the manual startup for the third time at 15:39 on March 11th, the station blackout occurred upon the tsunami arrival. Plant parameters thereafter, such as the measured reactor water levels, indicate that the RCIC could continue injecting water for about 3 days even after the DC power supply for control had been lost.

The measured reactor pressures after the tsunami arrival were maintained below the normal operating pressures, lower than the SRV working pressure. The RCIC operating conditions, which could cause such plant conditions, could be such that the RCIC had been driven by a mixture of steam and water, because the elevated reactor water level above the main steam lines had allowed water to flow into the main steam lines which had been designed to transfer only steam. In the MAAP analysis, the amount of water injected to the reactor was set at 30m³/h, one third of the rated value so that the measured reactor pressures could be reproduced. The overall plant behavior while the RCIC was in operation could be well reproduced in this simulation.

On the other hand, the plant behavior before the reactor water level reached the main steam line level is unknown still. The MAAP analysis assuming 30% of the rated flow rate underestimates the reactor water level. But the actual amount of water injected by the RCIC can be considered to have been more than the assumed 30m³/h on the following grounds: the RCIC turbine steam regulator valve is designed to fully open upon the loss of the control power supply; and the amount of decrease of water inventory in the condensate storage tank (CST), which was used as the water reservoir for water injection by the RCIC.

The RCIC operational conditions need to be clarified after the loss of the control power supply due to the tsunami.

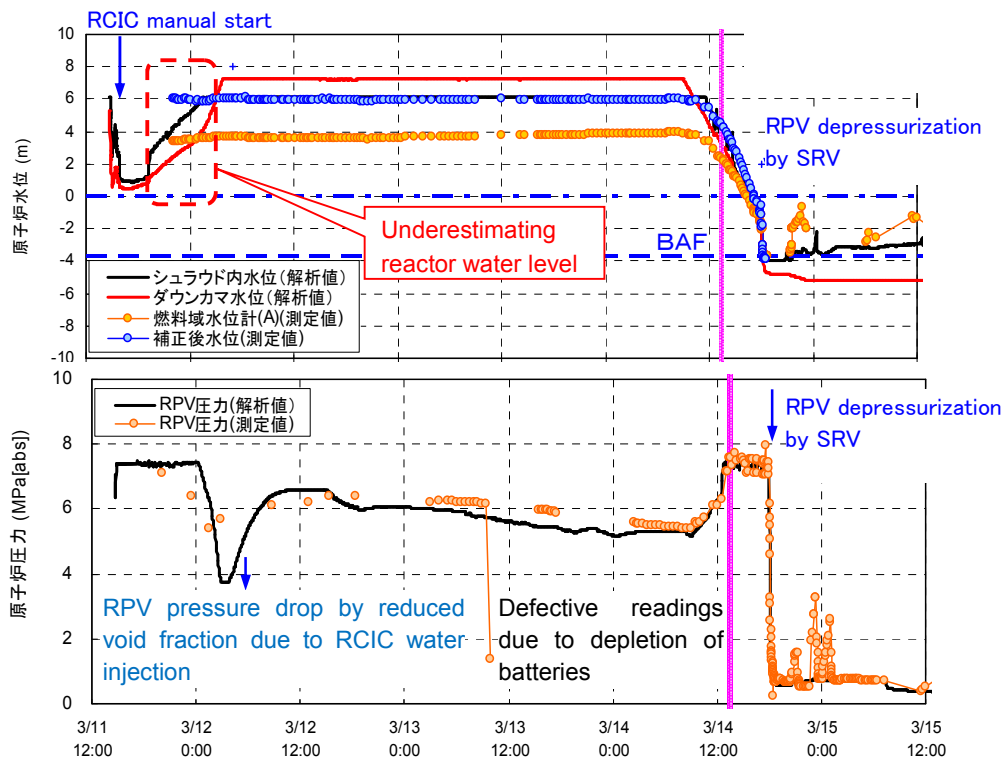

Figure Reactor water level and pressure changes at Unit-2

[Back to List of Issues/Unit-2](#)

Unit-2/Issue-2	Unit-2	Category A②	Class (1)	Safety measures in [1]: pp.20, 29
Cause of RCIC shutdown at Unit-2				Results: -

At Unit-2, the RCIC repeated manual startups and automatic shutdowns due to the high reactor water level after the earthquake. Immediately after the manual startup for the third time, the station blackout occurred upon the tsunami arrival. Plant parameters thereafter such as the measured reactor water levels indicate that the RCIC could continue injecting water for about 3 days even after the DC power supply for control had been lost.

At about 09:00 on March 14th, the reactor pressure showed an increasing trend, and at about 12:00 noon the reactor water level showed a decreasing trend. The Emergency Response Center at the Fukushima Daiichi NPS concluded at 13:25 that the RCIC had lost its functions, but it is necessary to clarify why it lost them.

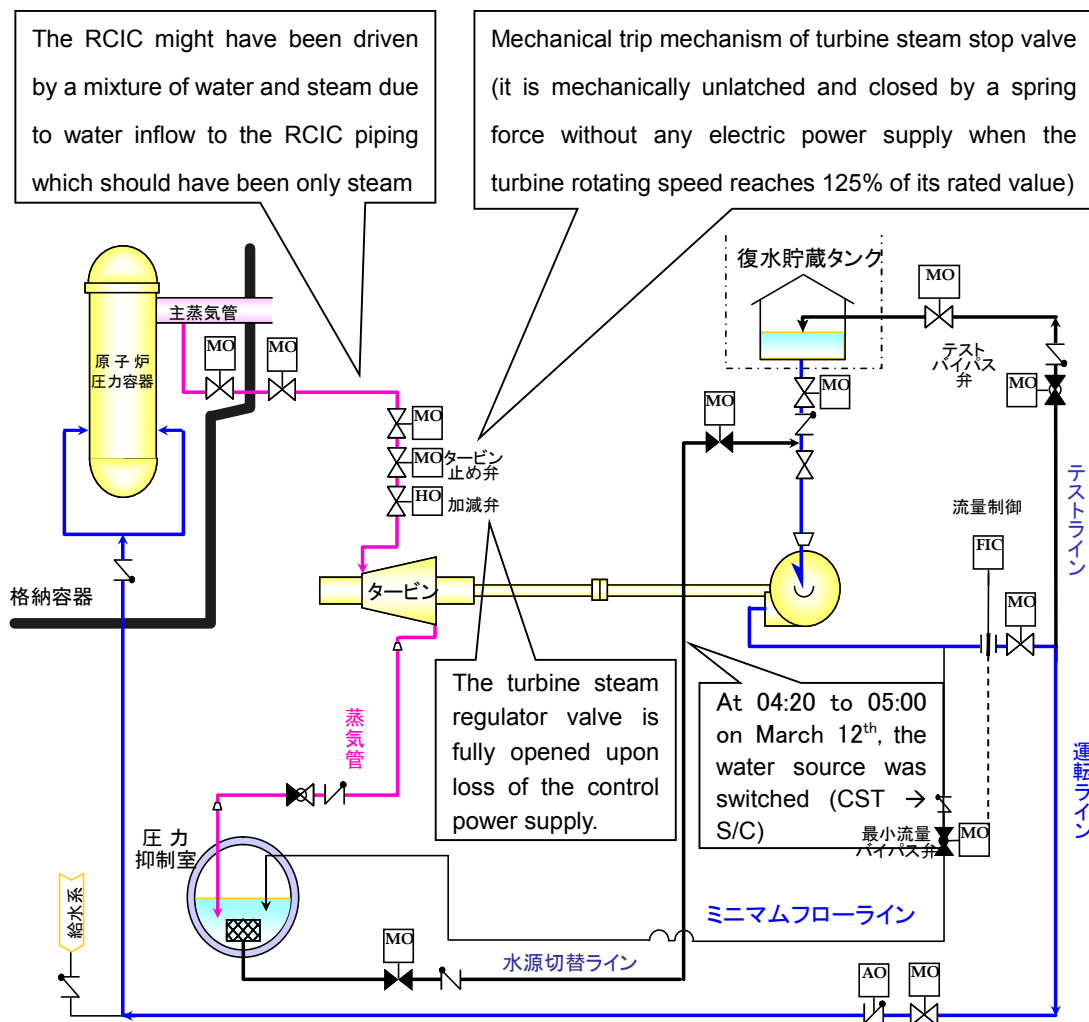

Figure RCIC schematic diagram

[Back to List of Issues/Unit-2](#)

<List of issues –Unit-2>

Unit-2/Issue-3	Unit-2	Category A⑤	Class (2)	Safety measures in [1]: -
Behavior of S/C pressure of Unit-2 after 21:00 on March 14 th				Results: -
<p>The D/W pressure of Unit-2 gradually increased while the RCIC was in operation, and after the RCIC was shut down it began to decrease at about 13:00 on March 14th. Thereafter it increased at about 20:00, about 21:00, about 23:00 and reached about 0.75MPa[abs] probably due to incondensable gas accumulation in the D/W because of hydrogen generation and the SRV opening.</p> <p>In the meantime, the S/C pressure measured about the same value as that of the D/W from 04:30 to about 12:30 on March 14th by the pressure indicator originally installed to this plant. The measurement was interrupted thereafter by defective readings. When the measurement was resumed at 22:10 by an S/C pressure indicator introduced for accident management (AM), it showed a lower value than that of the D/W. The S/C pressure indicator for AM was to measure the reference leg pressure of the S/C water level indicator mounted on a branch line off the S/C venting line.</p> <p>Such a discrepancy between the D/W and S/C pressures is very unrealistic for the PCV structural reasons. These pressure indicators should indicate consistent values. For this reason, the S/C pressure indicator is likely to have indicated wrong values. Eventually, the S/C pressure indicator downscaled at 06:00 on March 15th and the instrumentation system seems to have gone out of service. There is a possibility that the behavior of these pressure indicators and the timing of their failure may provide some meaningful information.</p>				

<List of issues –Unit-2>

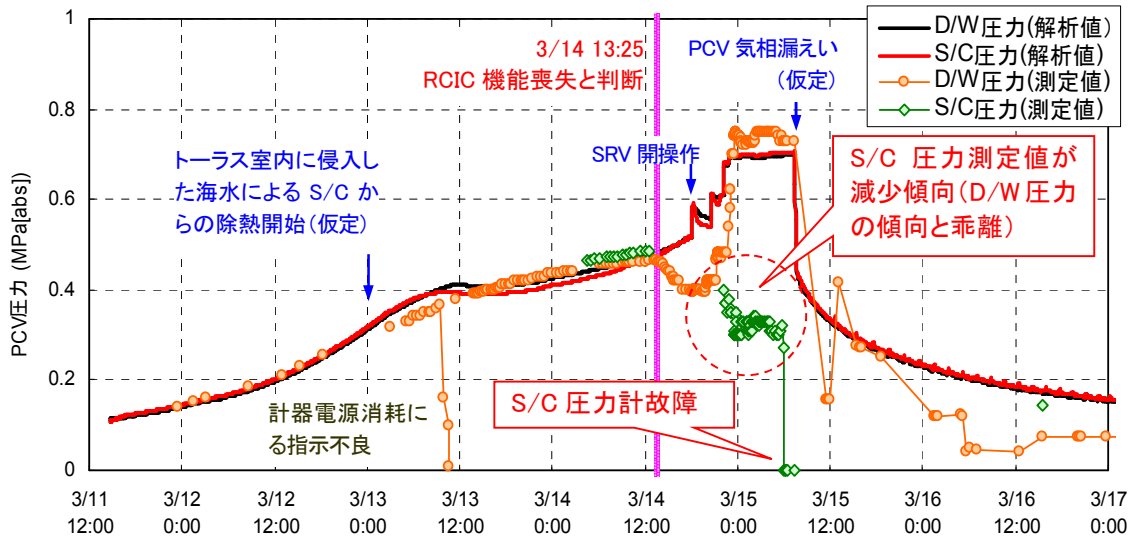

3/14 13:25 RCIC 機能喪失と判断	At 13:25 March 14 th , loss of function of RCIC concluded
トラス室内に侵入した海水による S/C からの除熱開始 (仮定)	Heat removal from S/C started by the seawater inundating the torus room (assumed)
計器電源消耗による指示不良	Defective readings due to depletion of batteries
S/C 圧力計故障	S/C pressure gage failed
PCV 気相漏えい (仮定)	Gaseous leak from PCV (assumed)
SRV 開操作	SRV opening operation
S/C 圧力測定値が減少傾向 (D/W 圧力の傾向と乖離)	S/C pressure readings started to decrease (deviating from D/W pressure readings)
S/C 圧力計故障	S/C pressure indicator failed

Figure PCV pressure changes in Unit-2

[Back to List of Issues/Unit-2](#)

Unit-2/Issue-4	Unit-2	Category A⑤	Class (2)	Safety measures in [1]: -
Unit-2 RHR system operating conditions after tsunami arrival				Results: Attachment 2-5

At Unit-2, the residual heat removal system (RHR) pump started up after the earthquake and the S/C pool water was being cooled by recirculation via a heat exchanger. The RHR pump stopped due to the loss of power when the tsunami arrived. Even without pumps, the S/C pool water might have been cooled by some mechanism as long as the recirculation cooling line had been established.

The recorder chart of the outlet and inlet temperatures of the RHR heat exchanger ended its recording due to the loss of power supply upon the tsunami arrival, but it was temporarily resumed on March 26th, when the power supply for the recorder was restored. The temperature recorded on March 26th was higher than normal (before the tsunami arrival).

Examination will be done on the reason for the temperature increase and its possible connection to the post-earthquake RHR operation. , No temperature records are available for comparison at Unit-1 and Unit-3.

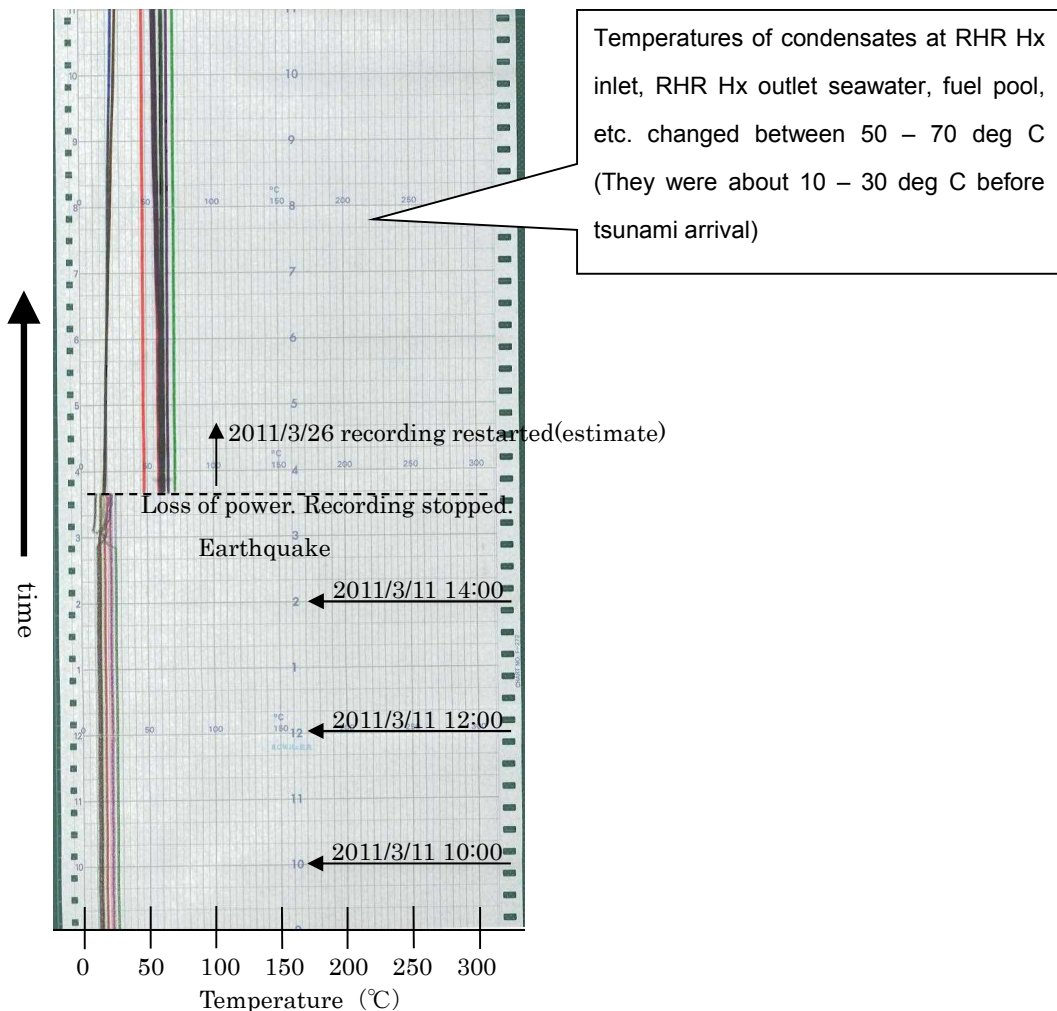

Figure Temperature recorder chart of Unit-2 (RHR and fuel pool temperatures)

[Back to List of Issues/Unit-2](#)

Unit-2/Issue-5	Unit-2	Category B①	Class (2)	Safety measures in [1]: -
PCV pressure behavior at Unit-2 after about 13:00 on March 14 th				Results: Attachment 2-6

The D/W pressure of Unit-2 increased gradually while the RCIC was in operation. It began to decrease at about 13:00 on March 14th after the RCIC had been shut down. Theoretically, the decay heat in the RPV is transferred to the S/C by steam whether the RCIC is in operation or shutdown, and the D/W pressure is anticipated to increase gradually.

The above-mentioned D/W pressure decrease could be explained by possible leaks from the PCV. But it cannot explain the pressure increase afterward. Another possible interpretation was that the D/W pressure decrease was due to the continued total S/C energy inventory decrease by the heat removal by the water accumulated in the torus room, because the energy could not be transferred to the PCV (D/W) via the S/C by the RCIC turbine until starting energy transfer via SRV. However, the latest MAAP analysis could not reproduce the phenomena of the PCV pressure decrease. There is another inconsistency: the PCV pressure decrease started more than 1 hour later than 12:00 noon when the RCIC is estimated, from the RPV pressure increasing trend, to have completely stopped. This timing almost coincides with the timing when the energy transfer from the SRV to the S/C started; therefore, the scenario of continued heat removal through the S/C walls combined with the energy flow (to the S/C from the RCIC turbine) termination cannot be explained.

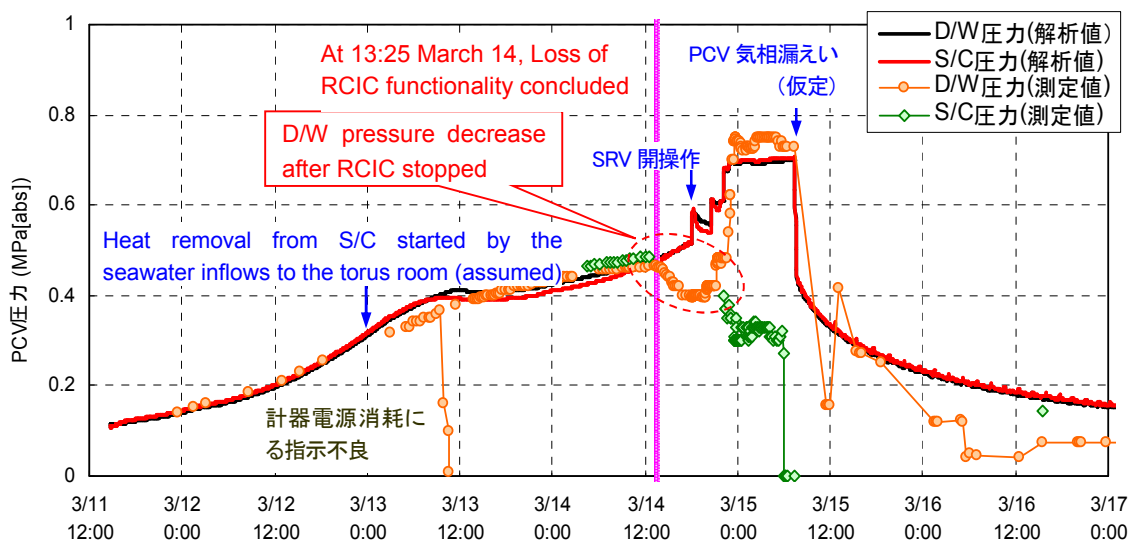

SRV 開操作	SRV opening operation
PCV 気相漏えい(仮定)	Gaseous leak from PCV (assumed)

Figure PCV pressure changes in Unit-2

[Back to List of Issues/Unit-2](#)

<List of issues –Unit-2>

Unit-2/Issue-6	Unit-2	Category B①	Class (2)	Safety measures in [1]: -
PCV pressure behavior upon forced SRV opening at Unit-2				Results: Attachment 2-6
<p>At Unit-2 the manual forced depressurization of the reactor was successfully completed at 18:02 on March 14th by the opening operation of the SRV(s). Theoretically, the D/W pressure should increase by a large amount of steam (energy) flow into the S/C upon forced depressurization by the SRV(s). Nevertheless, it remained at about 0.4MPa[abs] from 17:00 through 20:00.</p> <p>It should be noted that, thereafter at about 20:00, 21:00 and 23:00 on March 14th, the D/W pressure showed an increase and reached about 0.75MPa[abs], probably due to the accumulation of the incondensable gases.</p> <p>The MAAP analysis predicted the pressure increase upon forced depressurization. It is necessary to clarify the pressure change behavior upon forced depressurization by the SRV(s).</p>				

<List of issues –Unit-2>

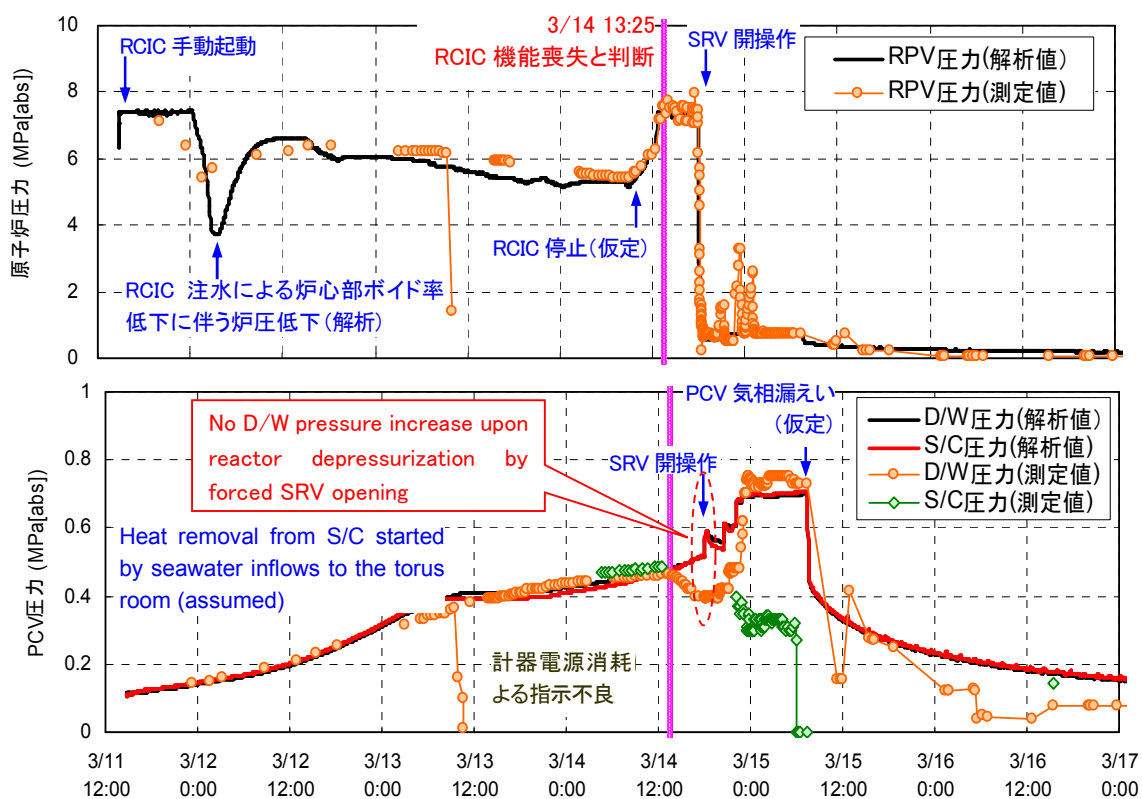

RCIC 手動起動	RCIC manually started
RCIC 注水による炉心部ボイド率低下に伴う炉圧低下 (解析)	RPV pressure decrease by reduced void fraction by RCIC water injection (anal.)
3/14 13:25 RCIC 機能喪失と判断	At 13:25 March 14 th , loss of function of RCIC concluded
RCIC 停止(仮定)	RCIC stopped (assumed)
SRV 開操作	SRV opening operation
SRV 強制開による原子炉減圧時、D/W 圧力上昇なし	No D/W pressure increase upon reactor depressurization by forced SRV opening
トラス室内に侵入した海水による S/C からの除熱開始 (仮定)	Heat removal from S/C started by the seawater inflow to the torus room (assumed)
計器電源消耗による指示不良	Defective readings due to depletion of batteries
PCV 気相漏えい(仮定)	Gaseous leak from PCV (assumed)

Figure Pressure changes of RPV and PCV at Unit-2

[Back to List of Issues/Unit-2](#)

Unit-2/Issue-7	Unit-2	Category B①	Class (2)	Safety measures in [1]: -
RPV pressure increase after forced depressurization at Unit-2				Results: Attachment 2-7, 2-9

At Unit-2 the manual forced depressurization of the reactor was successfully completed at 18:02 on March 14th by the opening operation of the SRV(s). The SRV(s) were repeatedly opened thereafter in order to control the intermittent reactor pressure increase. But the operation records of SRV opening and the RPV pressure decrease do not always coincide. For instance, the operations of manual opening are recorded twice at 21:20 on March 14th and at 01:10 on March 15th, but no record of confirming the SRV manual opening exists at the time of reactor pressure increase and decrease at about 23:00 on March 14th.

After the forced depressurization of the reactor, fire engines continued to inject water. Therefore, possible causes of the pressure increase are: steam production due to the increased water level; steam production due to corium slumping to the lower plenum; steam production by the zirconium-water reactions; or even the SRV closures. RPV and PCV pressure behavior after the reactor forced depressurization is to be examined.

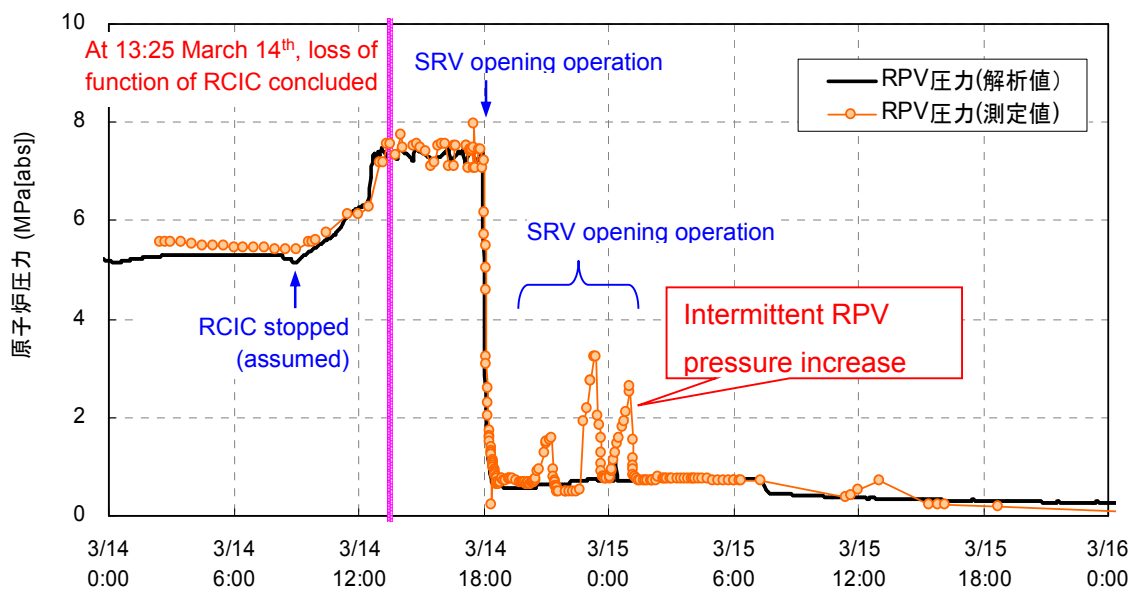

Figure RPV pressure changes at Unit-2

[Back to List of Issues/Unit-2](#)

<List of issues –Unit-2>

Unit-2/Issue-8	Unit-2	Category B③	Class (1)	Safety measures in [1]: pp.27~36
Leaks in gaseous phase from Unit-2 RPV				Results: Attachment 2-10
<p>At Unit-2 the forced depressurization of the reactor was successfully completed at 18:02 on March 14th by the opening operation of the SRV(s).</p> <p>The SRV(s) were repeatedly opened thereafter in order to control the intermittent reactor pressure increase. But the operation records of SRV opening and the RPV pressure decrease do not always coincide. For instance, the operations of manual opening are recorded twice at 21:20 on March 14th and at 01:10 on March 15th, but no record of confirming the SRV manual opening exists at the time of reactor pressure increase and decrease at about 23:00 on March 14th.</p> <p>The reactor water level indicator readings showed about the BAF level at the time of the forced depressurization, and the core melting progressed thereafter. In view of this, gaseous leaks might have occurred from the reactor vessel, due to, for example, damage of TIP tubes, which composed the pressure boundary. In addition, no further operations of SRV opening for depressurization were taken after a certain time.</p> <p>But there is no direct evidence in the measured plant parameters or observed events which shows when and from where the leaks actually occurred. Clarification is needed.</p>				

<List of issues –Unit-2>

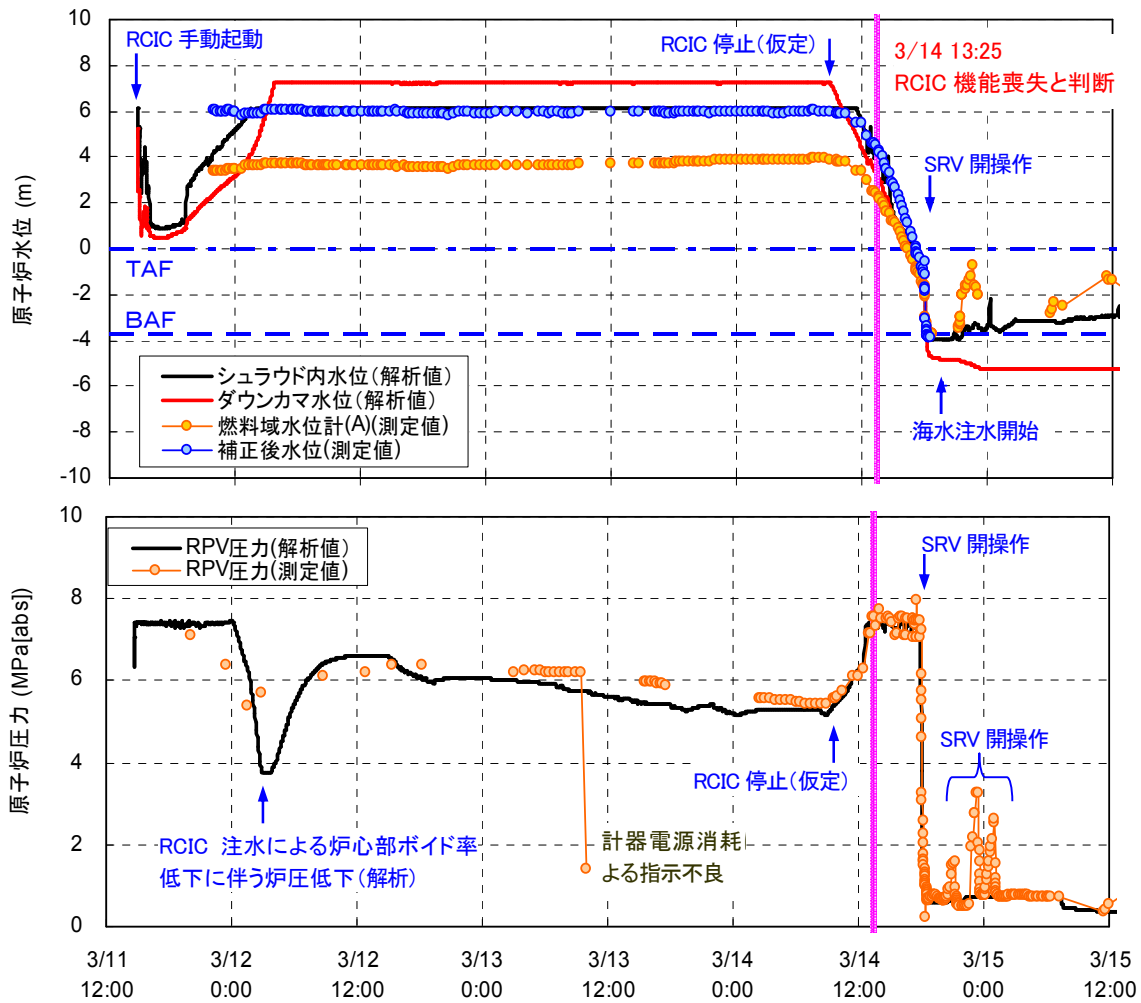

RCIC 手動起動	RCIC manually started
RCIC 停止(仮定)	RCIC stopped (assumed)
3/14 13:25 RCIC 機能喪失と判断	At 13:25 March 14 th , loss of function of RCIC concluded
SRV 開操作	SRV opening operation
海水注水開始	Seawater injection started
RCIC 注水による炉心部ボイド率低下に伴う炉圧低下(解析)	RPV pressure decrease by reduced void fraction due to RCIC water injection
計器電源消耗による指示不良	Defective readings due to depletion of batteries
RCIC 停止(仮定)	RCIC stopped (assumed)
SRV 開操作	SRV opening operation

Figure RPV water level and pressure changes at Unit-2

[Back to List of Issues/Unit-2](#)

Unit-2/Issue-9	Unit-2	Category B①	Class (2)	Safety measures in [1]: p.40
Consideration of possible rupture disc actuation at Unit-2				Results: Attachment 4
<p>At Unit-2 the RCIC could continue injecting water with no power source for control, which had been lost due to the tsunami. But, since the need to vent the PCV was foreseen in due course, the venting line was configured by 11:00 on March 13th except for the rupture disc actuation.</p> <p>However, the large S/C vent valve (AO-valve) was confirmed to have been closed by the impacts of the explosion of the Unit-3 reactor building. Finally, the valve is considered to have become inoperable for opening actions due to the defective solenoid valve.</p> <p>At about 21:00 on March 14th, the small S/C vent valve was slightly opened by activating its solenoid valve. The venting line configuration was completed again except for the rupture disc actuation, but it was reported that the small S/C valve had been in the “Closed” position at 23:35 on March 14th.</p> <p>The S/C venting was thus being prepared for, but no clear evidence exists whether it actually was successful. Even if the S/C pressure indicators did not provide true values, the measured D/W pressure exceeded the rupture disc working pressure (528kPa[abs]) at about 23:00 on March 14th (540kPa[abs]). The S/C venting flow rate with the opened small S/C vent valve is limited, and so the D/W pressure decrease also will be limited. On the other hand, the monitoring car measured a sharp radiation dose increase near the main gate at about 21:20 on March 14th when the SRV opening was recorded.</p> <p>Clarification is needed to interpret the causes of the radiation dose increase, including the possibilities of PCV venting being implemented and the rupture disc actuation.</p>				

<List of issues –Unit-2>

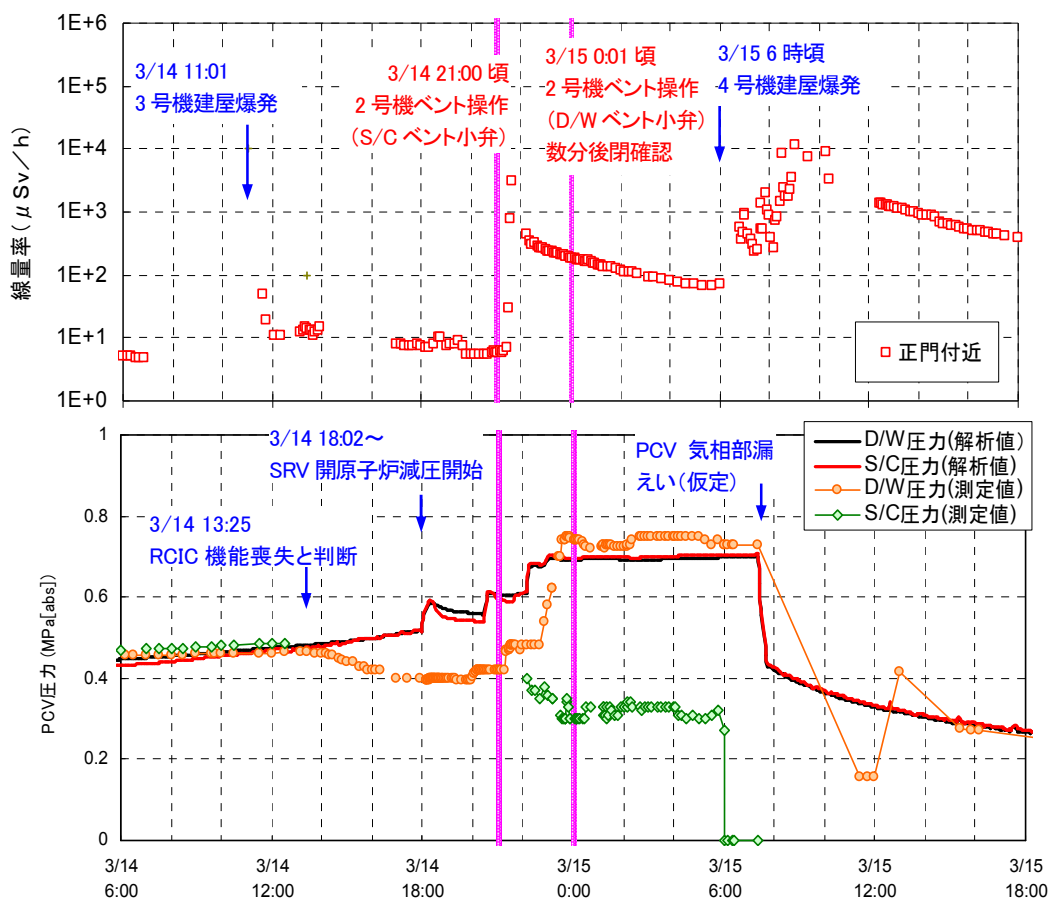

3/14 11:01 3号機建屋爆発	At 11:01 March 14 th Unit-3 R/B exploded
3/14 21:00頃 2号機ベント操作(S/C ベント小弁)	At about 21:00 March 14 th SRV venting operation at Unit-2 (small S/C venting valve)
3/15 0:01頃 2号機ベント操作(D/W ベント小弁) 数分後閉確認	At about 00:01 March 14 th SRV venting operation at Unit-2 (small D/W venting valve)
3/15 6時頃 4号機建屋爆発	At about 06:00 March 15 th Unit-4 R/B exploded
3/14 13:25 RCIC 機能喪失と判断	At 13:25 March 14 th , loss of function of RCIC concluded
3/14 18:02~ SRV 開原子炉減圧開始	At 18:02 March 14 th SRV opened, RPV depressurization started
PCV 気相部漏えい(仮定)	Gaseous leak from PCV (assumed)

Figure Radiation dose near the main gate and PCV pressure changes upon Unit-2 venting
[Back to List of Issues/Unit-2](#)

<List of issues –Unit-2>

Unit-2/Issue-10	Unit-2	Category B①	Class (2)	Safety measures in [1]: -
Condensation behavior upon hydrogen-rich steam release at Unit-2				Results: Attachment 2-8, 2-13

At Unit-2 the forced depressurization of the reactor was successfully completed at 18:02 on March 14th by the opening operation of the SRV. Further at about 21:00 on March 14th, an attempt was made to open another SRV because the reactor pressure had increased, but the pressure did not decrease. Further a third SRV was then actuated and the reactor pressure decreased at 21:20.

The reactor pressure was about 1.5MPa when it increased at about 21:00, when the core melting is considered to have been already progressing. Therefore, the exhaust upon reactor depressurization would have contained a large amount of hydrogen gas, a non-condensable gas. The non-condensable gas in the exhaust will cause pressure increase behavior different from that due to only steam in the exhaust. Clarification is needed concerning possible impacts on the S/C integrity due to hydrogen-rich steam release.

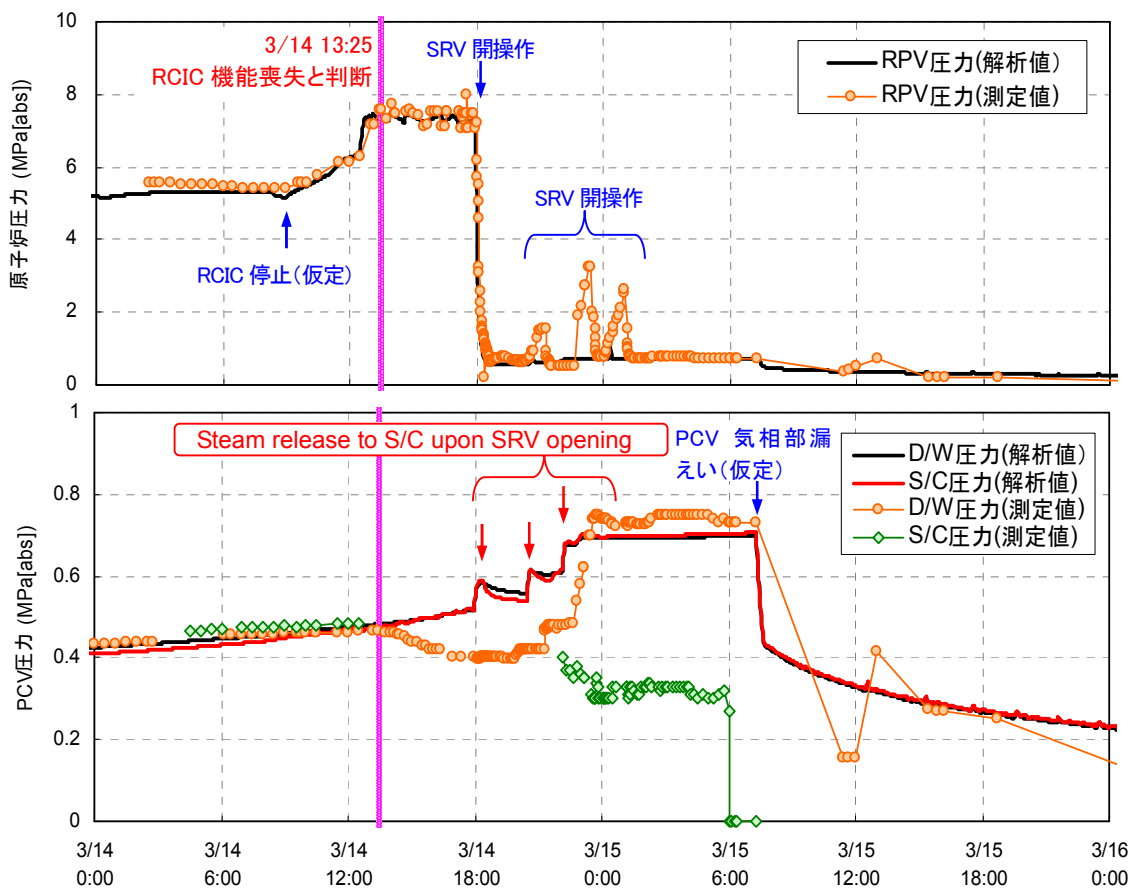

3/14 13:25 RCIC 機能喪失と判断	At 13:25 March 14 th , loss of function of RCIC concluded
RCIC 停止(仮定)	RCIC stopped (assumed)
SRV 開操作	SRV opening operation
SRV 開による S/C への蒸気放出	Steam release to S/C upon SRV opening
PCV 気相部漏えい(仮定)	Gaseous leak from PCV (assumed)

Figure RPV and PCV pressure changes at Unit-2

[Back to List of Issues/Unit-2](#)

Unit-2/Issue-11	Unit-2	Category B①	Class (1)	Safety measures in [1]: pp 27-43
Leaks in gaseous phase from the Unit-2 PCV				Results: -
<p>The PCV pressure of Unit-2 gradually increased while the RCIC was in operation, and after the RCIC was shutdown increases, probably due to hydrogen production and the opening of SRVs, occurred at about 20:00, about 21:00, and about 23:00; PCV pressure reached about 0.75MPa[abs].</p> <p>Thereafter at about 07:20 on March 15th, the measured PCV pressure was 0.73MPa[abs], and that decreased to 0.155MPa[abs] by 11:25. It is not certain when the PCV pressure started to decrease, because the workforce at the Fukushima Daiichi NPS was then temporarily reduced and the points of measurements available are insufficient. However, it is likely that the PCV pressure started to decrease during the morning, since (i) steam was confirmed as being discharged in the dawn of March 15th from the blow-out panel located in the Unit-2 reactor building wall, and (ii) the air dose rate near the main gate increased. The steam discharge is estimated to have been repeated from the morning till night on March 15th, and the radioactive materials released during this time period are considered to have caused contamination of the adjacent areas including Iitate Village.</p> <p>It can be further considered that the leaks had started sometime between about 23:30 on March 14th, when the PCV pressure had changed above 0.7MPa[abs], and about 07:20 on March 15th.</p> <p>But no direct evidence has been identified from the measured plant parameters or observed facts concerning at what time and at what point the leaks actually occurred. Clarification is needed.</p>				

<List of issues -Unit-2>

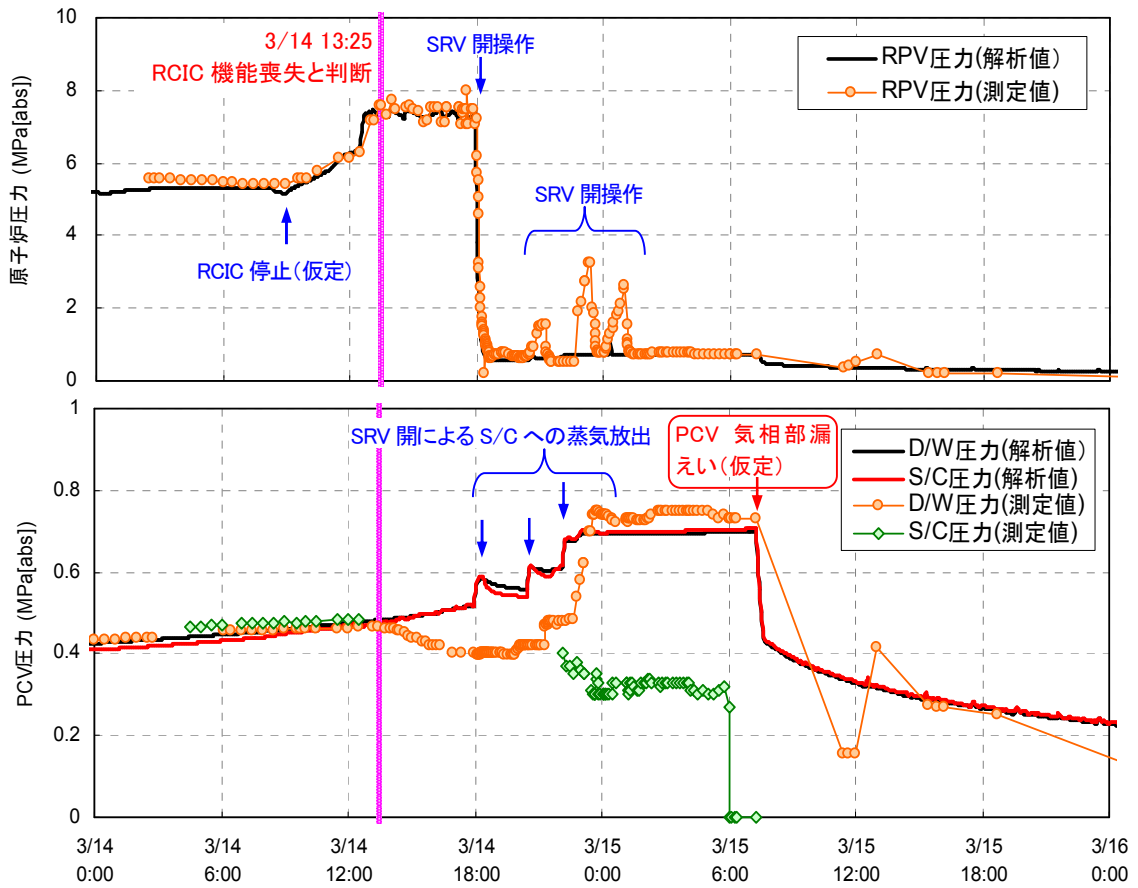

3/14 13:25 RCIC 機能喪失と判断	At 13:25 March 14 th , loss of function of RCIC concluded
RCIC 停止(仮定)	RCIC stopped (assumed)
SRV 開操作	SRV opening operation
SRV 開による S/C への蒸気放出	Steam release to S/C upon SRV opening
PCV 気相部漏えい(仮定)	Gaseous leak from PCV (assumed)

Figure RPV and PCV pressure changes at Unit-2

[Back to List of Issues/Unit-2](#)

Unit-2/Issue-12	Unit-2	Category B⑤	Class (2)	Safety measures in [1]: -
Sharp increase of CAMS readings on March 15 th at Unit-2				Results: Attachment 2-10, 2-11

The CAMS (D/W) readings of Unit-2 recorded from the morning of March 15th were monotonically increasing before around 06:00 (63Sv/h at 06:20). After about a 6-hour blank period, it read 46Sv/h at 11:25. This can be interpreted as having reflected the dose rate decrease in the PCV as the result of FP release to the environment.

Thereafter, the CAMS (D/W) recorded a rapid increase to 135Sv/h at 15:25 on March 15th. This rapid increase may have been caused by some unknown changes of the situation in the RPV and PCV. It will be investigated what phenomena could have occurred around this time period.

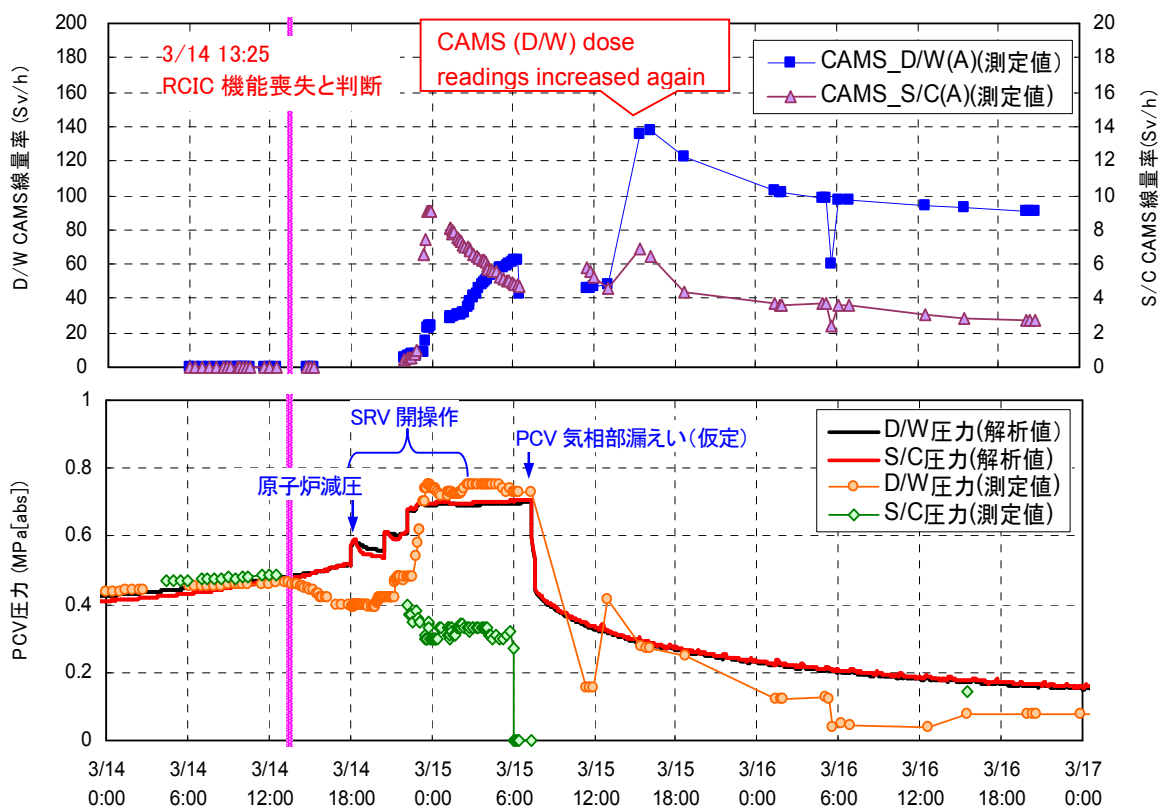

3/14 13:25 RCIC 機能喪失と判断	At 13:25 March 14 th , loss of function of RCIC concluded
D/W CAMS 線量率の再上昇	CAMS (D/W) dose readings increased again
原子炉減圧	RNP depressurization
SRV 開操作	SRV opening operation
PCV 気相部漏えい(仮定)	Gaseous leak from PCV (assumed)

Figure Changes of CAMS readings and PCV pressures at Unit-2

[Back to List of Issues/Unit-2](#)

Unit-2/Issue-13	Unit-2	Category B⑥	Class (1)	Safety measures in [1]: pp.43-44
Grounds for no hydrogen explosion at Unit-2				Results: -

Hydrogen explosions occurred at the reactor buildings of Unit-1, 3 and 4, but not at Unit-2. Possible interpretation of this difference is considered to be the fact that the blow-out panel in the operating floor wall of the Unit-2 reactor building was opened. But, there is no quantitative justification for this incident. Quantitative evaluation in detail concerning the amount of hydrogen generation or steam partial pressure will be needed to explain why the hydrogen explosion did not occur at Unit-2.



Figure Opened blow-out panel of Unit-2

[Back to List of Issues/Unit-2](#)

<List of issues – Unit-3>

Unit-3/Issue-1	Unit-3	Category A②	Class (1)	Safety measures in [1]: p. 20, 29
Causes of shutdown of RCIC at Unit-3				Results: Attachment 3-5

The RCIC of Unit-3 was in shutdown status due to the high reactor water level signal at 15:25 on March 11th just before the tsunami arrival. It was manually started up at 16:03 because a DC power supply had still been available, enabling water injection into the reactor to be continued with the operator's control and, in combination with the SRV(s), to control the reactor pressure and water level. For water injection, the CST was used as its water source, using both the reactor water injection line and the test line, to avoid the RCIC automatic shutdown by the high reactor water level signal because the rated water injection rate was larger than the water decreasing rate by evaporation. The use of two lines for water injection was also to avoid battery depletion by the RCIC repeated startup and shutdown operations as well as to maintain the reactor water level in a stable manner.

At 11:36 on March 12th, the status indicator lamp on the MCR control panel showed shutdown of the RCIC, and the flow meter and discharge pressure indicator readings all became zero. The RCIC was thus confirmed to have shut down. The shutdown condition was locally confirmed in the RCIC room, too, afterward. It was attempted to restart the RCIC after resetting it from the MCR control panel, but immediately after attempting the restart, the steam stop valve trip mechanism was unlatched, the steam stop valve was closed and the RCIC was shut down.

On the next day after the HPCI stopped operating, it was attempted to restart the RCIC again at 05:08 on March 13th after the steam stop valve mechanism had been properly latched, adjusted, and the pre-service status had been checked, but again the steam stop valve was closed and the RCIC restart attempt failed.

The RCIC could continue working beyond its design condition of 8 hours, but, in order to increase the RCIC system reliability, it is necessary to clarify the battery capacities and real loads, and the reason why the stop valve mechanism was unlatched.

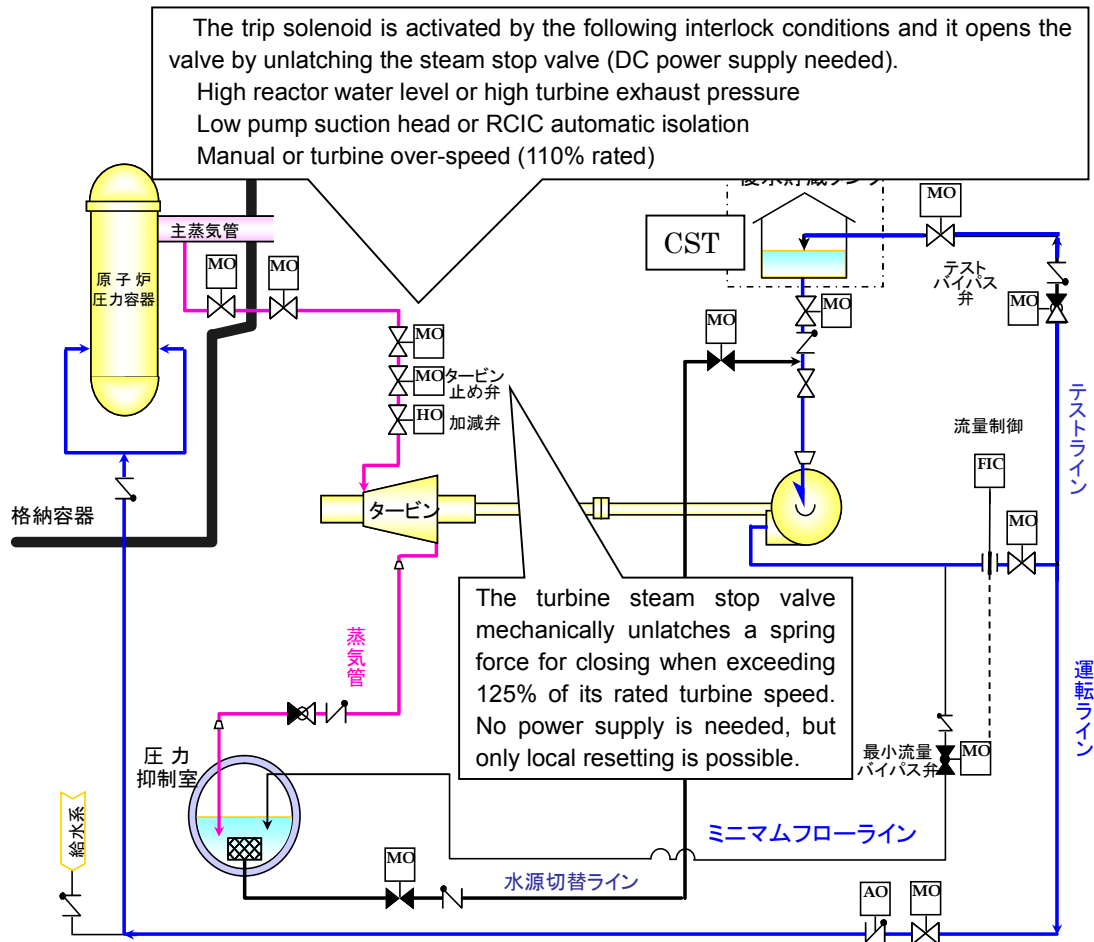

Figure Schematic RCIC line configuration

[Back to List of Issues/Unit-3](#)

<List of issues – Unit-3>

Unit-3/Issue-2	Unit-3	Category A⑤	Class (2)	Safety measures in [1]: -
RPV water level indicator readings at Unit-3 after loss of true value indications				Results: -
<p>The reactor water level indicators of Unit-3 showed roughly constant values after about 12:00 on March 13th, irrespective of the water injection conditions. It can be considered that the water level indicators were out of order, like those of Unit-1, because of the water level decrease both in their reference leg and variable leg.</p> <p>The condensing chamber type water level indicators installed in the Fukushima Daiichi NPS reactors lose their water in their internal piping (reference leg and variable leg) by evaporation, causing them to show wrong values, when the PCV temperatures increase or the reactor pressures decrease.</p> <p>But, the water level indicator readings represent the pressure difference between the reference leg and the variable leg. This may provide some relevant information concerning the timing of reactor pressure decrease and/or reactor water level</p>				

<List of issues – Unit-3>

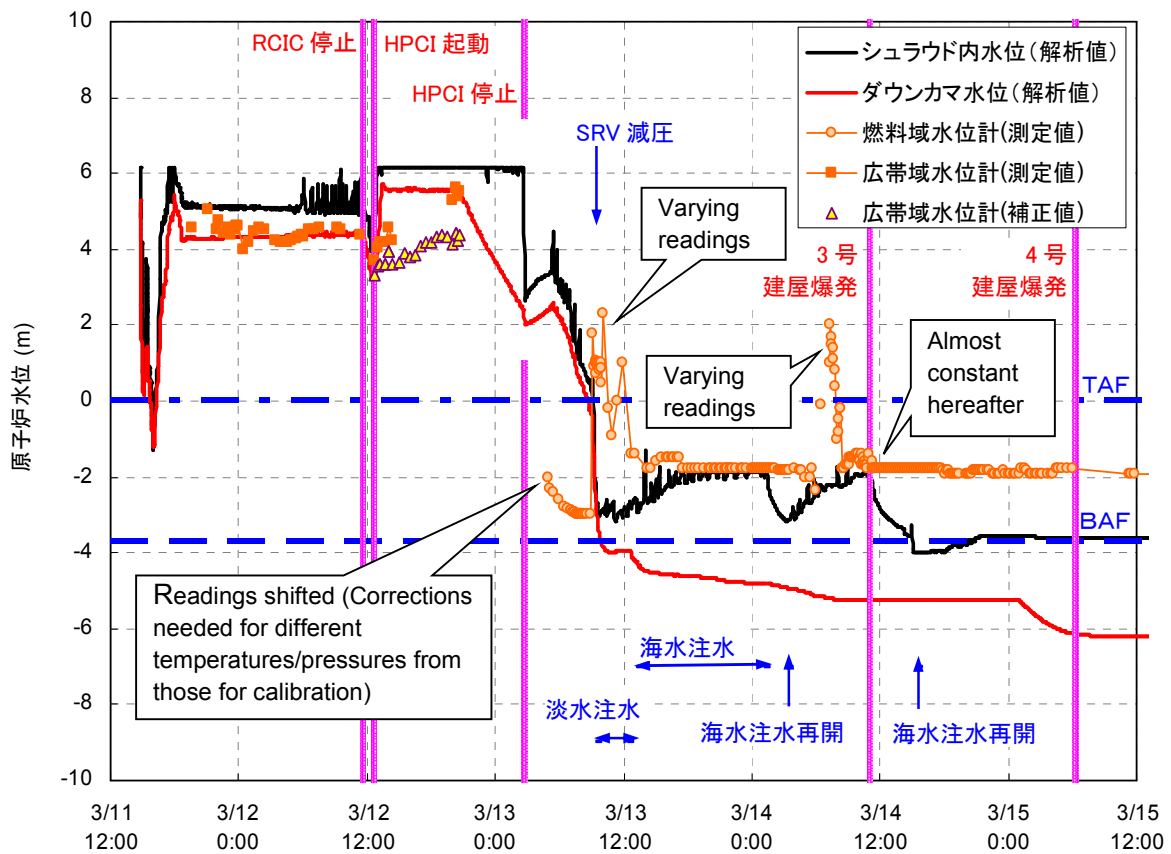

RCIC 停止	RCIC stopped
HPCI 起動	HPCI started
HPCI 停止	HPCI stopped
SRV 減圧	SRV depressurization
3号 建屋爆発	Unit-3 R/B exploded
4号 建屋爆発	Unit-4 R/B exploded
淡水注水	Freshwater injection
海水注水	Seawater injection
海水注水再開	Seawater injection resumed

Figure Reactor water level changes at Unit-3

[Back to List of Issues/Unit-3](#)

<List of issues – Unit-3>

Unit-3/Issue-3	Unit-3	Category B①	Class (1)	Safety measures in [1]: pp. 17, 18, 39, 40
Thermal stratification in the S/C of Unit-3				Results: Attachment 3-7
<p>The D/W pressure of Unit-3 was in an increasing trend due to the exhaust steam from the RCIC and SRV(s), while the RCIC was in operation after the tsunami arrival.</p> <p>When compared with the MAAP analysis results with the use of design conditions, the observed pressures until about 22:00 of March 12th showed a larger and faster increase. The MAAP analysis could not simulate this pressure behavior (the D/W pressures increases were much larger as compared with the MAAP results until about 12:00 when the HPCI started operation, and the analysis pressures by MAAP continued to increase afterward while the observed pressures decreased rapidly).</p> <p>JNES suggested a possibility (*) of thermal stratification in the upper part of the S/C pool water causing a local temperature rise which led to the larger D/W pressure increase as compared with the uniform temperature rise of the S/C pool water. The thermal stratification would have been generated by the high temperature exhaust steam from the RCIC turbine only heating the S/C pool surface water.</p> <p>Further examination is due into the D/W pressure changes until about 22:00 on March 12th.</p> <p>(*) “Examinations into the impacts of thermal stratification in the suppression chamber water on the containment vessel pressures, and other parameters”, issued Feb. 1st, 2012, by the Japan Nuclear Energy Safety Organization (in Japanese)</p>				

<List of issues – Unit-3>

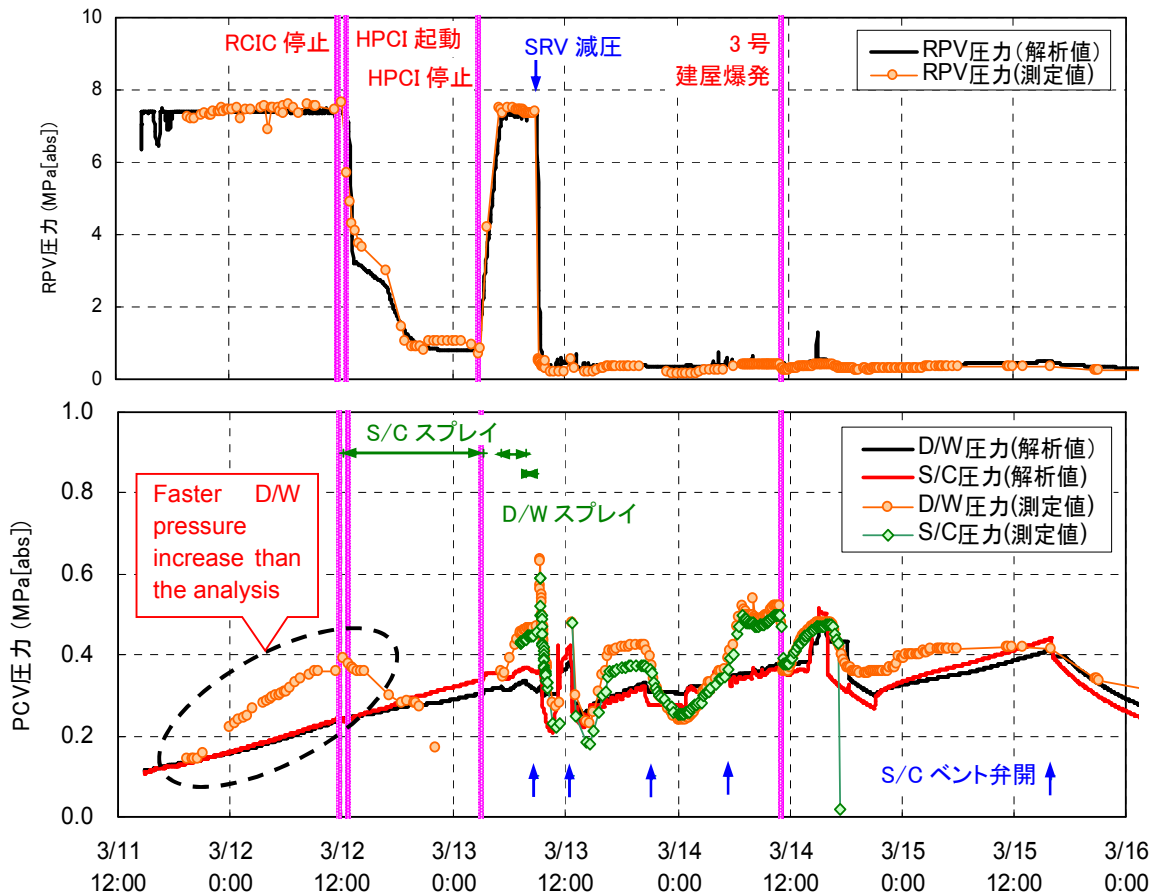

RCIC 停止	RCIC stopped
HPCI 起動	HPCI started
HPCI 停止	HPCI stopped
SRV 減圧	SRV depressurization
3号建屋爆発	Unit-3 R/B exploded
指示値の乱れ	Varying readings
S/C スプレイ	S/C sprayed
D/W スプレイ	D/W sprayed
S/C ベント弁開	S/C venting valve opened

Figure Pressure changes of RPV and D/W of Unit-3

[Back to List of Issues/Unit-3](#)

<List of issues – Unit-3>

Unit-3/Issue-4	Unit-3	Category B①	Class (2)	Safety measures in [1]: p. 26 (for strengthened monitoring)
Reactor water level behavior during HPCI operation at Unit-3				Results: Attachment 3-3
<p>At Unit-3, the HPCI was adjusting the amount of water injection into the reactor by both using its return line to the CST water source and adjusting the set points of the flow controller while confirming the water level indicator to prevent the HPCI from being shut down by the high reactor water level signal (L-8). At 20:36 on March 12th, while the HPCI was in operation, the power supply to the reactor water level indicators was lost preventing the reactor water level from being monitored. The HPCI water injection flow rate of the flow controller was reset at a slightly increased level, and the reactor pressures, the HPCI discharge pressures, etc. were used to monitor the HPCI operation status.</p> <p>In the earlier MAAP analysis results, which TEPCO had disclosed in March 2012, the amount of water injection by the HPCI had been set to simulate the reactor water levels observed by the water level indicators (wide range). In the simulation, the reactor water levels measured until 20:36 on March 12th were used without corrections corresponding to the reactor pressures and PCV pressures. This caused the overestimation of the amount of water injected to the reactor in the MAAP analysis (The water level in the analysis is about 1m higher than that of measurement after such corrections). In consequence, it is likely that the amount of water actually injected by the HPCI was less than that assumed in the MAAP analysis.</p> <p>The amount of HPCI water injection will be reviewed and the real progression of the accident will be examined for estimating the core and PCV status.</p>				

<List of issues – Unit-3>

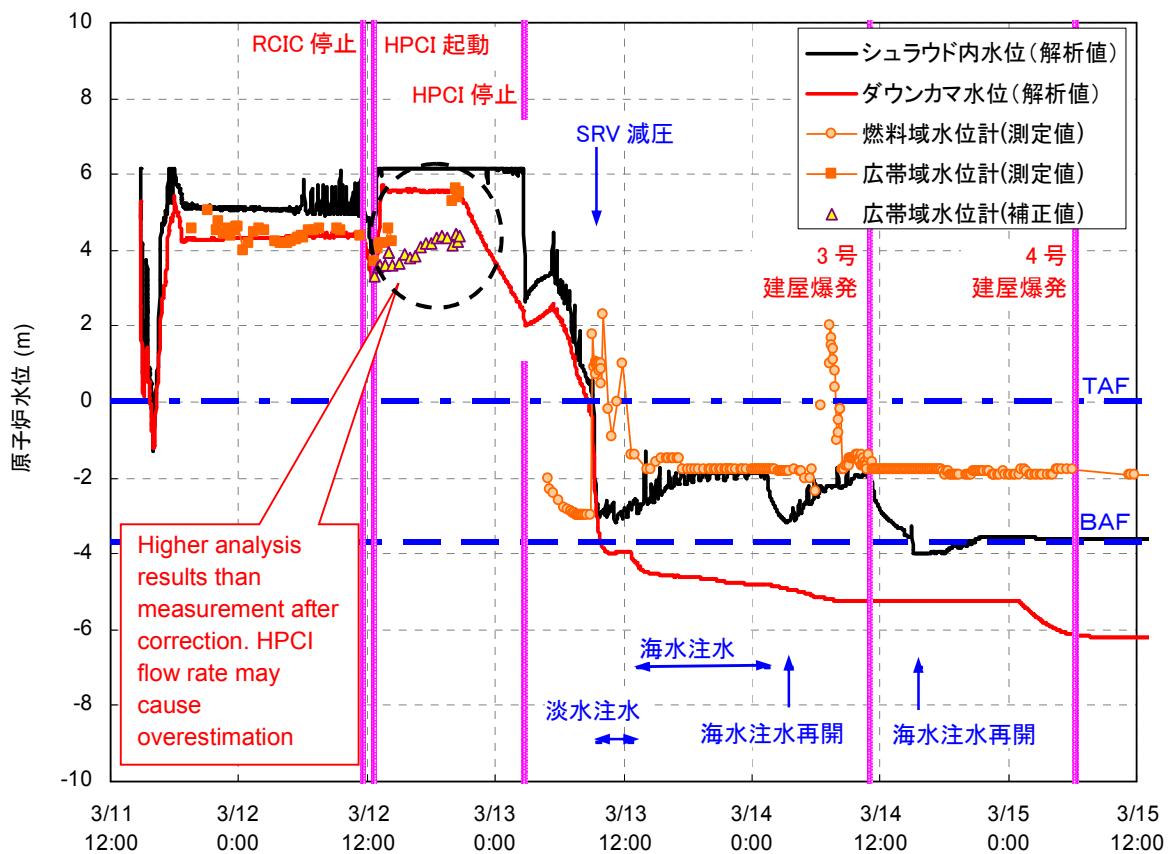

RCIC 停止	RCIC stopped
HPCI 起動	HPCI started
HPCI 停止	HPCI stopped
SRV 減圧	SRV depressurization
3号 建屋爆発	Unit-3 R/B exploded
4号 建屋爆発	Unit-4 R/B exploded
淡水注水	Freshwater injection
海水注水	Seawater injection
海水注水再開	Seawater injection resumed

Figure Reactor water level changes at Unit-3

[Back to List of Issues/Unit-3](#)

<List of issues – Unit-3>

Unit-3/Issue-5	Unit-3	Category B①	Class (2)	Safety measures in [1]: -
Reactor water level behavior after the loss of function of HPCI at Unit-3				Results: Attachment 3-3, 3-4
<p>At Unit-3, the HPCI was adjusting the amount of water injection into the reactor by both using its return line to the CST water source and adjusting the set points of the flow controller while confirming the water level indicator to prevent the HPCI from being shut down by the high reactor water level signal (L-8). At 20:36 on March 12th, while the HPCI was in operation, the power supply to the reactor water level indicators was lost preventing the reactor water level from being monitored. The HPCI water injection flow rate of the flow controller was reset at a slightly increased level, and the reactor pressures, the HPCI discharge pressures, etc. were used to monitor the HPCI operation status.</p> <p>From 20:36 on March 12th to about 04:00 on March 13th the reactor water levels were not measured. When the reactor water level indicators were restored, the fuel range water level indicator read about TAF-2m. But, the MAAP analysis maintained the water level higher than the TAF level until about 09:00 on March 13th when the Unit-3 was depressurized, overestimating the water level.</p> <p>This discrepancy indicates that the water actually injected by the HPCI after 20:36 on March 12th was less than that assumed in the MAAP analysis. It further indicates a possibility that the water injection by HPCI had actually ended before the HPCI was manually shut down at 02:42 on March 13th.</p> <p>In view of a high likelihood of a smaller amount of water actually being injected than that assumed in the analysis, the overestimated amount of HPCI water injection will be reviewed and the actual progression of the accident will be investigated for estimating the core and PCV status.</p>				

<List of issues – Unit-3>

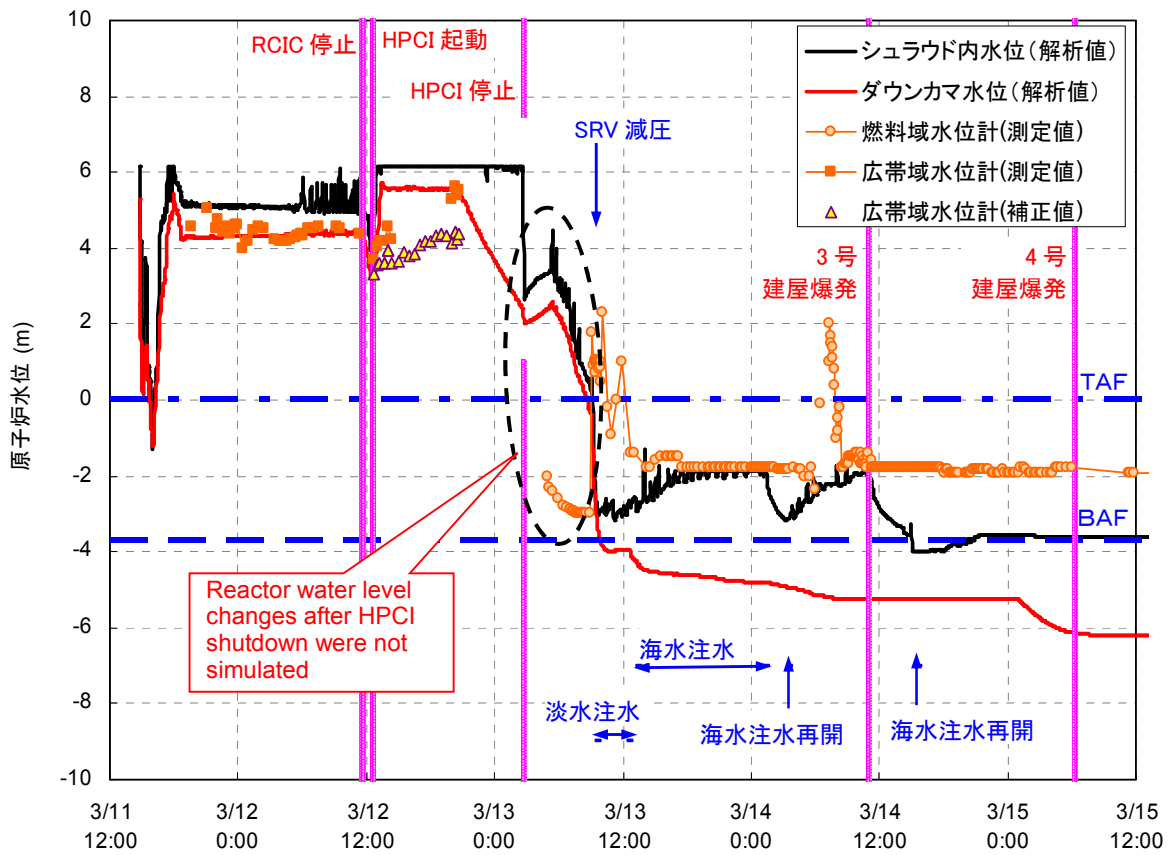

RCIC 停止	RCIC stopped
HPCI 起動	HPCI started
HPCI 停止	HPCI stopped
SRV 減圧	SRV depressurization
3号建屋爆発	Unit-3 R/B exploded
4号建屋爆発	Unit-4 R/B exploded
淡水注水	Freshwater injection
海水注水	Seawater injection
海水注水再開	Seawater injection resumed

Figure 12 Reactor water level changes at Unit-3

[Back to List of Issues/Unit-3](#)

<List of issues – Unit-3>

Unit-3/Issue-6	Unit-3	Category B①	Class (2)	Safety measures in [1]: -
Rapid depressurization at about 09:00 on March 13 th at Unit-3				Results: Attachment 3-3, 3-4

After the HPCI was manually shut down at 02:42 on March 13th at Unit-3, the reactor pressure started to increase and stayed at around 7MPa[abs] for about 5 hours. At about 09:08 on March 13th, while two members of the recovery group in the MCR were initiating the connection of ten 12V batteries in series, the shift operators recognized the reactor pressure started decreasing.

This pressure decrease can be confirmed in two types of observed data: measured values recorded by the operators and the chart records. From the chart records, continuous transient behavior can be read, although the exact values are not known. The pressure decrease rate thus read is as large as about 7MPa[abs] down to about 1MPa[abs] in 2 to 3 minutes.

At this time, the battery connection work to the SRV control panel was not completed. The pressure decrease did not occur by the SRV manual actuation. It is necessary to investigate the depressurization mechanism.

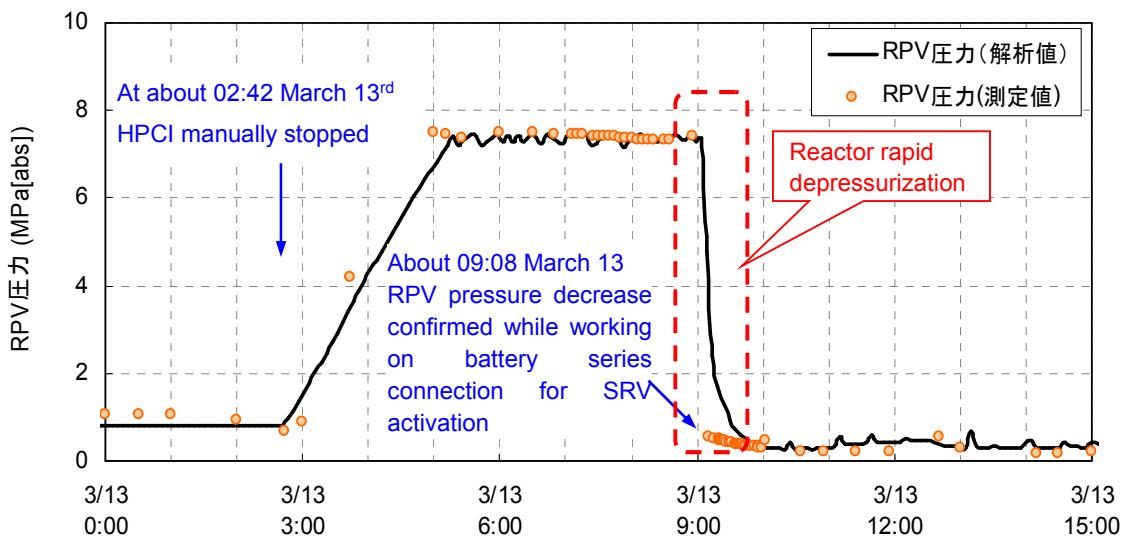

Figure Reactor pressure changes at Unit-3

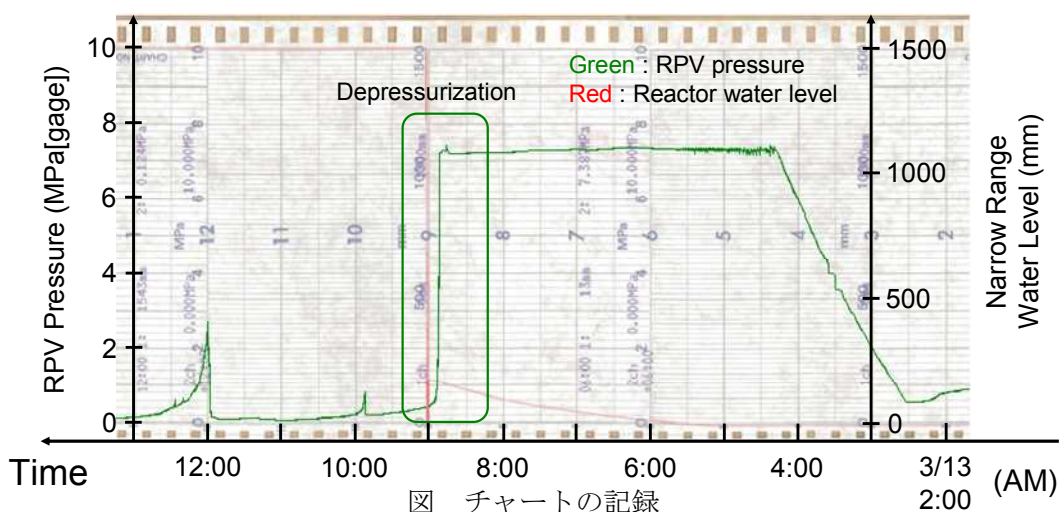

Figure Strip chart records

[Back to List of Issues/Unit-3](#)

<List of issues – Unit-3>

Unit-3/Issue-7	Unit-3	Category B①	Class (2)	Safety measures in [1]: -
RPV pressure behavior after rapid depressurization at Unit-3 on March 13 th				Results: Attachment 3-3, 3-4

After the HPCI stopped operation at Unit-3, the reactor pressure decrease was confirmed and the reactor vessel was depressurized, while the battery connection work was ongoing for the SRV opening operation. According to the chart records thereafter, the reactor pressure suddenly rose twice at about 10:00 and 12:00 on March 13th, and gradually decreased thereafter.

This pressure behavior, especially the pressure decrease, was considered and reported to be the responses to the SRV opening operations at 09:50 on March 13th upon the completion of battery connection and at about 12:00 upon the recovery from having found disconnected wiring. However, the pressure rise at these two times is very sharp as compared with the pressure increase at 02:42 on March 13th, when the HPCI had stopped operation.

The pressure behavior should be similar in the two cases, when the HPCI turbine steam regulator valve is closed upon the HPCI being shut down and when the SRV(s) are closed, because both cases are equivalent in having lost the steam discharge paths. But the observed pressure increase behavior is actually different. The sharp pressure increase might have been caused by the relocation of molten fuel down to the lower plenum or the generation of a large amount of hydrogen.

The pressure change mechanism and its relevance to the accident progression will be investigated.

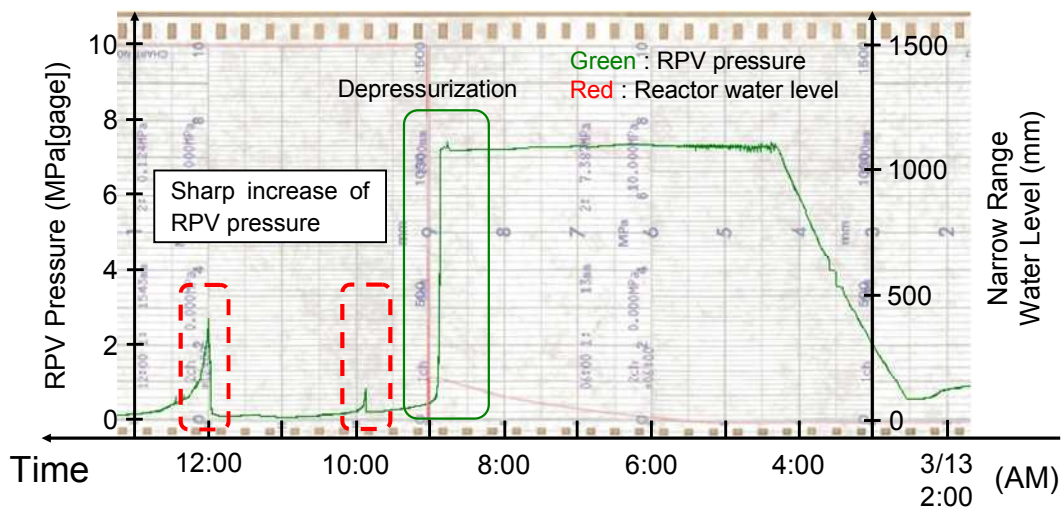

Figure Strip chart records (March 13th, 2011)

[Back to List of Issues/Unit-3](#)

<List of issues – Unit-3>

Unit-3/Issue-8	Unit-3	Category B①	Class (2)	Safety measures in [1]: p.40
PCV pressure behavior upon venting operations at Unit-3				Results: Attachment 3-8

The Emergency Response Center at the Fukushima Daiichi NPS concluded that the PCV had been vented once at Unit-3 when the D/W pressure decrease had been observed at 09:24 on March 13th following the completion of S/C venting line configuration at 08:41 on March 13th. Thereafter, the large S/C vent valve (air-operated) was closed several times due to problems of driving air pressure or the actuation circuit using a temporary small generator. Each time it was attempted to open the large S/C vent valve by solving the problem causes.

The D/W pressures observed during this period repeatedly went up and down, but their timings were mostly not consistent with the timings of repeated opening operations of the large S/C vent valve. The flow rate changes anticipated by the small S/C vent valve opening operations seem too limited to explain the measured D/W pressure changes.

The causes of the D/W pressure changes during the series of venting operations will, therefore, be investigated.

<List of issues – Unit-3>

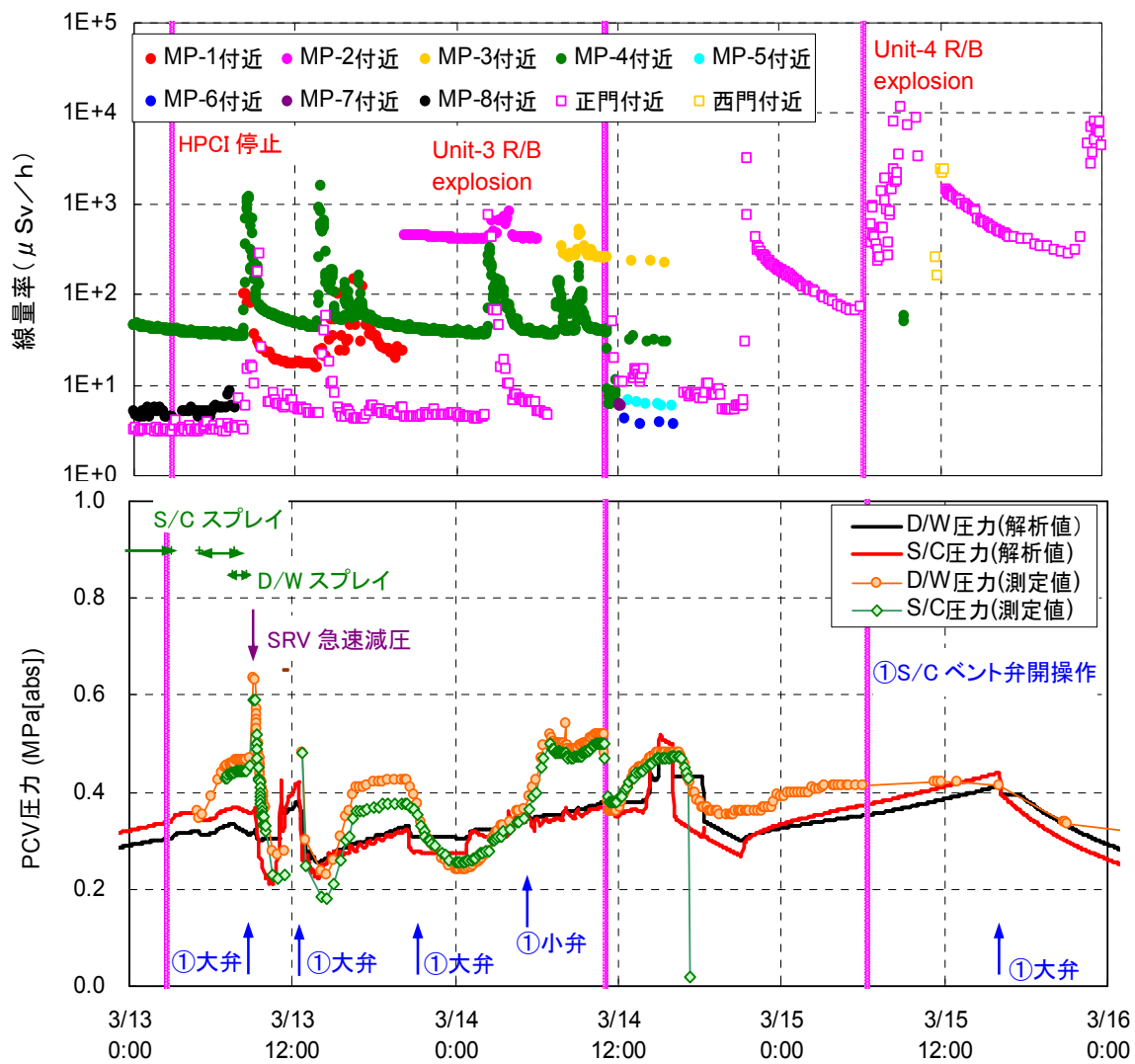

HPCI 停止	HPCI stopped
3号建屋爆発	Unit-3 R/B explosion
4号建屋爆発	Unit-4 R/B explosion
S/C スプレー	S/C sprayed
D/W スプレー	D/W sprayed
SRV 急速減圧	SRV rapid depressurization
① S/C ベント弁開操作	S/C venting valve opening operation
① 大弁	S/C venting by large valve opening operation
① 小弁	S/C venting by small valve opening operation

Figure Dose rate changes at the NPS (upper) and D/W pressure changes at Unit-3 (lower)

[Back to List of Issues/Unit-3](#)

<List of issues – Unit-3>

Unit-3/Issue-9	Unit-3	Category B③	Class (1)	Safety measures in [1]: pp. 27-36
Leaks in gaseous phase from Unit-3 RPV				Results: -
<p data-bbox="188 309 1406 439">No steam leakage from the RPV was assumed in the MAAP analysis, but a possibility will be investigated concerning leaks in gaseous phase from the RPV caused by overheated fuel and melting therein.</p> <p data-bbox="1054 501 1406 533" style="text-align: right;">Back to List of Issues/Unit-3</p>				

<List of issues – Unit-3>

Unit-3/Issue-10	Unit-3	Category B③	Class (1)	Safety measures in [1]: pp.27-43
Leaks in gaseous phase from Unit-3 PCV				Results: Attachment 3-8
<p>At Unit-3, the D/W pressure increase due to the rapid reactor depressurization at about 09:00 on March 13th led to the S/C pressure increase big enough to exceed the rupture disk working pressures. Thereafter the D/W pressure decrease at 09:24 on March 13th was confirmed and the PCV venting was concluded to have been implemented.</p> <p>It was considered that the D/W pressure repeated thereafter ups and downs corresponding to the steam generation by water injection and to the venting operations. After it increased for a while on March 21st, it stayed at around atmospheric pressure, with no big changes.</p> <p>The MAAP analysis assumed no PCV leaks in Unit-3, but the steam leak from the PCV seems probable because the steam explosion occurred in the Unit-3 reactor building, steam release was observed near the reactor well in the reactor building, and the D/W pressure showed no big changes after March 21st at around atmospheric pressure.</p> <p>Adding to that, when nitrogen gas was injected into the PCV, Unit-3 showed no pressure changes in the PCV, while Unit-1 and -2 showed pressure increases in their PCVs. There is another relevant observation concerning the oxygen concentrations in the PCV air, when measured by the PCV gas control system, i.e., it was almost zero in Unit-1 and -2, while it was high in Unit-3, indicating the possibility of air inflow into the PCV.</p> <p>It is considered, therefore, Unit-3, for which the operators attempted to repeat venting operations, would have had the largest leaks in the gaseous phase. Further investigation is needed to clarify when and from where the leaks in the gaseous phase actually occurred.</p>				

<List of issues – Unit-3>

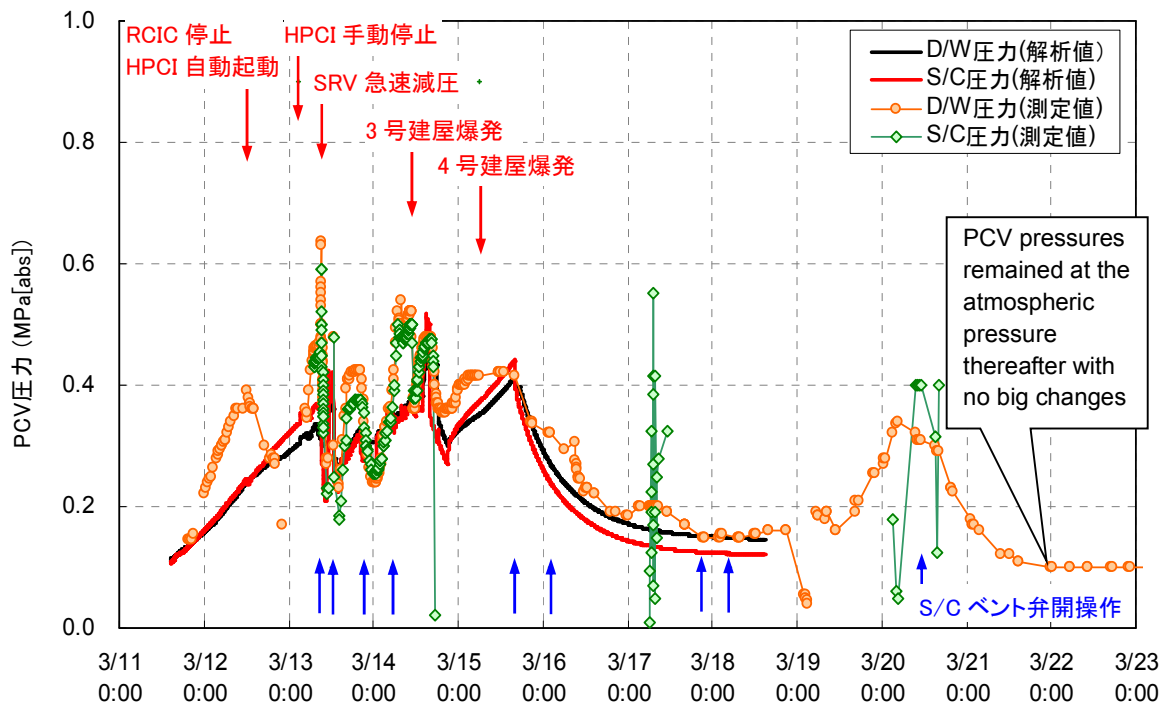

RCIC 停止	RCIC stopped
HPCI 自動起動	HPCI automatically started
HPCI 手動停止	HPCI manually stopped
SRV 急速減圧	SRV rapid depressurization
3号建屋爆発	Unit-3 R/B explosion
4号建屋爆発	Unit-4 R/B explosion
S/C ベント弁開操作	

Figure PCV pressure changes at Unit-3

[Back to List of Issues/Unit-3](#)

<List of issues – Unit-3>

Unit-3/Issue-11	Unit-3	Category B④	Class (2)	Safety measures in [1]: -
Large amount of steam discharge from the top of Unit-3 reactor building				Results: Attachment 3-8

At Unit-3 a large amount of steam was observed to be blowing upward above the reactor building: dark smoke was observed on March 21st; and steam rising was observed on March 29th from the top and west side of the reactor building. Even after the spent fuel storage pool temperature was lowered sufficiently, steam release above the building was repeatedly observed.

Movie sequences on August 24th, 2011, taken at the time of dust sampling above the reactor building, show steam leaking from the shield plug margin and the periphery of the deformed dryer separator (DS) pit gates.

Steam thus observed seems to be leaking from the PCV and it may provide some useful information to identify the leak locations.



Photograph taken on March 16th, 2011



Photograph taken on March 21st, 2011

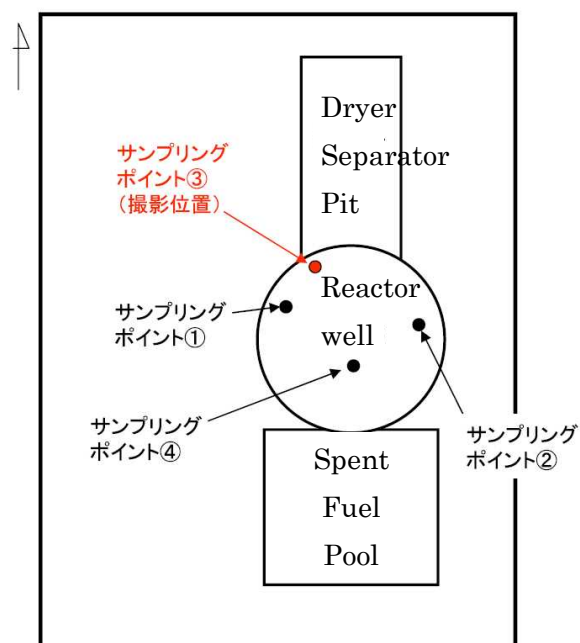

福島第一原子力発電所3号機原子炉建屋5階配置図



撮影者：東京電力株式会社
撮影日：平成23年8月24日

[Back to List of Issues/Unit-3](#)

<List of issues – Unit-3>

Unit-3/Issue-12	Unit-3	Category B⑦	Class (2)	Safety measures in [1]: -
Impacts of water injection interruptions on the accident progression s				Results: -
<p>Water injection by fire engines to the Unit-3 reactor was interrupted by the hydrogen explosion of Unit-3 R/B at 11:01 on March 14th. The water injection was considered to have been resumed about 16:30 on March 14th, but the latest investigation has led to the conclusion that it had been resumed at 15:30, about one hour earlier. Water injection to Unit-3 reactor was again halted in order to secure the water for injection into the Unit-2 reactor. It has been also found that water injection to Unit-3 reactor was resumed again at 02:30 on March 15th.</p> <p>The impacts on the time sequences of water injection to the Unit-3 reactor on the accident progression will be checked.</p> <p style="text-align: right;">Back to List of Issues/Unit-3</p>				