

The cause of RCIC shutdown in Unit 3

1. Outline of the incident and issues to be examined

Unit 3 experienced a station blackout when it was hit by tsunami on March 11th, 2011, following the reactor scram, and while the reactor core isolation cooling (RCIC) system had been automatically shut down due to the high reactor water level signal at 15:25 after the system had been manually started at 15:05. Even after the tsunami, DC power sources remained available, and water injection was continued by restarting the RCIC manually again at 16:03. But at 11:36 on March 12th, the status indicator lamp in the main control room (MCR) confirmed the RCIC had been automatically shut down. Operators confirmed also in the RCIC room the situation that RCIC had been shut down and relevant valves were reset on the MCR control board for standby and restart. But immediately after attempting the restart, the stop valve trip mechanism was unlatched, the valve closed and the RCIC failed to restart. Although the RCIC continued to function longer than the designed 4 hours under the station blackout conditions, the cause of the Unit 3 RCIC shutdown was examined, based on actual plant conditions observed and design information, in order to interpret the accident progression and to contribute to further safety enhancements by improvements of relevant equipment and operational procedures.

2. Relevant operational actions and local situations

Table 1 shows the chronological records of relevant operational actions taken and incidents observed until the time of the Unit 3 RCIC trip at 11:36 on March 12th and that of operational actions for the restart.

<RCIC startup at 16:03 on March 11th, 2011>

The RCIC was automatically shut down at 15:25 on March 11th, due to a high reactor water level signal just before the tsunami arrival. It was manually started up at 16:03, as the DC power source was still available after the tsunami hit. Thus, the main steam relief safety valve (SRV) and RCIC could continue controlling the reactor pressure and water level of Unit 3.

Under these circumstances, the operators configured the water injection line through both the RCIC injection line and its test line by valve operations on the RCIC control panel. This was done to avoid battery depletion due to RCIC startup and shutdown, and to maintain the stable reactor water level by using the condensate storage tank (CST) as the water source. In order to ensure moderate transition of the reactor water level, the flow rate was controlled within a predefined range by adjusting the test line valve apertures and the flow indicator and controller (FIC). Figure 1 shows the RCIC diagram and the operational status.

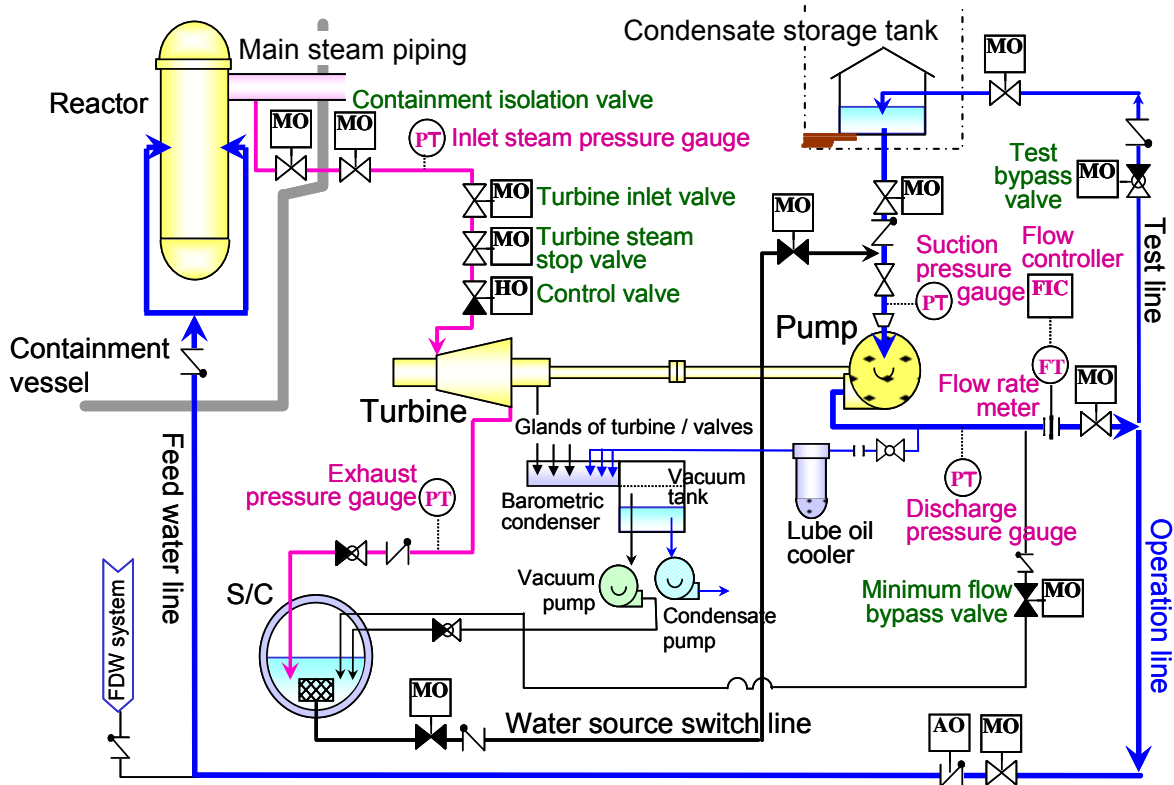

Figure 1 RCIC system diagram

<RCIC shutdown at 11:36 on March 12th, 2011>

The RCIC status indicator lamp on the MCR control panel showed it had been shut down, and the indicators showed zeros for discharged flow rate and pressure, confirming the RCIC shutdown. Operators reset the relevant RCIC valves on the RCIC control panel for restart, and then attempted to restart, but it was followed by immediate shutdown after the restart operations, and then operators made an on-site check. They entered the RCIC room through the HPCI room. They noticed that water had flooded the floor as deep as their ankles (about 10 – 20 cm) in both rooms, but the air did not feel damp. Water drips were falling on the stop valve, etc., from the RCIC room ceiling, but nothing abnormal was noticed on the turbine, pumps, piping, etc.

As the RCIC was confirmed locally to be out of service and no anomalies were noticed about the mechanical structures of the steam stop valve, the operators tried again to restart the RCIC from the MCR control panel by resetting and restarting valve operations, but the steam stop valve closed immediately after and the RCIC shut down. While operators were struggling for maneuvering the RCIC for status confirmation and restart actions, the high pressure core injection system (HPCI) automatically started up due to low reactor water level signal and water injection started again.

Table 1 Chronology of RCIC operational actions and incidents observed at Unit 3

Date	Time	Incident observed	Reference
3/11	14:47	Reactor scrammed automatically	(1)
3/11	14:48	Emergency diesel generator (DG) started up automatically	(1)
3/11	15:05	RCIC started up manually	(1)
3/11	15:25	RCIC shut down automatically (high reactor water level signal)	(1)
3/11	15:38	Station blackout	(1)
3/11	16:03	<p>RCIC started up manually</p> <ul style="list-style-type: none"> ➤ Operators configured the water injection line through both the RCIC injection line and its test line by valve operations on the RCIC control panel. This was done to avoid battery depletion due to RCIC startup and shutdown, and to maintain a stable reactor water level. In order to ensure moderate transition of the reactor water level, the flow rate was controlled within a predefined range by adjusting the test line valve apertures and flow indicator and controller (FIC). ➤ Except for essential systems required for monitoring and control, all other non-urgent loads were disconnected to save the batteries. Regarding monitoring instrumentations, only one channel out of redundant channels A and B was kept connected. Emergency lightings and clocks in the MCR were disconnected, as well as fluorescent lights in other rooms. 	(1)
3/12	11:36	<p>RCIC shut down automatically</p> <ul style="list-style-type: none"> ➤ RCIC status indicator lamp showed “shut down.” Zeros on the RCIC discharged flow rate and pressure indicators were confirmed. 	(1)
	to	<p>RCIC restart operations taken</p> <ul style="list-style-type: none"> ➤ Operators tried to restart the RCIC after the valve reset operations on the RCIC control panel, which was followed by an immediate shutdown after restart operations, and then operators were sent for an on-site check. ➤ The operators entered the RCIC room through the HPCI room. They noticed water had flooded the floor as deep as their ankles (about 10 – 20 cm) in both rooms, but the air did not feel damp. Water drips were falling on the stop valve, etc., from the RCIC room ceiling, but nothing abnormal was noticed on the turbine, pumps, piping, etc. ➤ As the RCIC was confirmed locally to be out of service and no 	(1)

Date	Time	Incident observed	Reference
		anomalies were noticed about the mechanical structures of the steam stop valve, the operators tried again to restart the RCIC from the MCR control panel by resetting and restarting valve operations, but the steam stop valve closed immediately and the RCIC shut down accordingly.	
3/12	12:35	HPCI automatically started up due to the signal "low reactor water level."	(1)

(1) Fukushima Nuclear Accident Analysis Report, TEPCO, June 20, 2012

http://www.tepco.co.jp/en/press/corp-com/release/betu12_e/images/120620e0102.pdf

<Trip mechanism of RCIC stop valve and its resetting procedures (reference information)>

The RCIC turbine can be tripped by two different mechanisms: electrical trip and mechanical overspeed trip. In an unusual situation, the turbine trip stop valve is closed to cut the steam flow. Figure 2 shows a schematic diagram of the turbine steam stop valve and trip mechanisms.

A latch mechanism is built in the upper part of the valve where its stem is driven. In the electrical trip mechanism, the trip signal (an automatic trip signal from the interlock or manual trip signal) excites the trip solenoid and releases the latch. When unlatched, the spring in the valve cylinder expands and the steam stop valve is fully closed.

In the mechanical trip mechanism, the tappet in the overspeed trip mechanism is pushed upward, which works on the rod connected to the latch mechanism by spring forces, leading to the unlatching. The electrical mechanism needs a DC power source just as the RCIC needs it for operation and control, while the mechanical mechanism can work even if no DC power source is available.

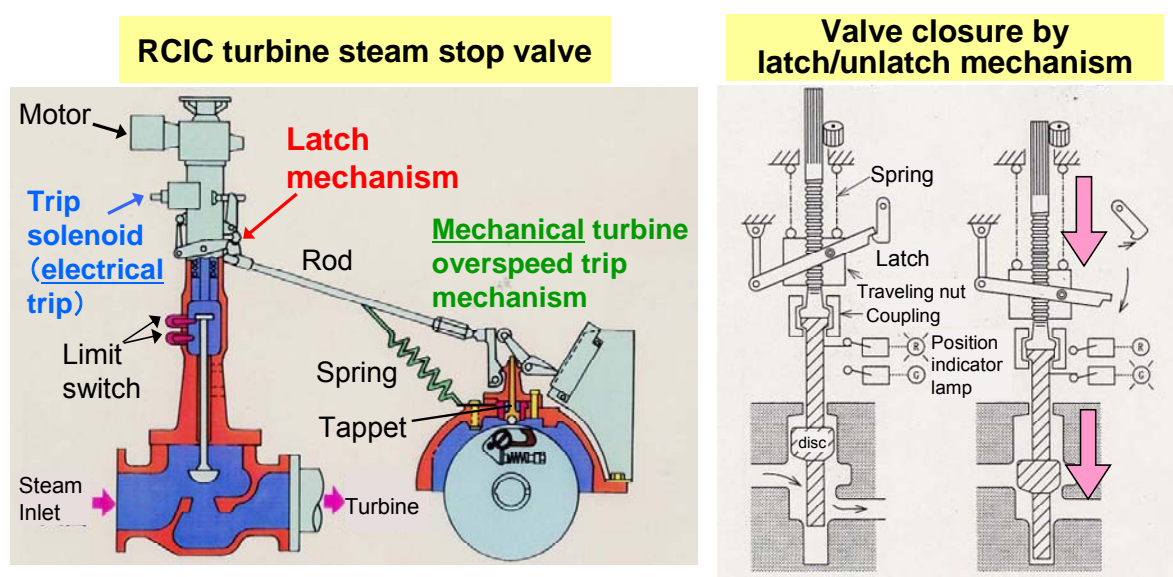

Figure 2 Schematics of RCIC turbine steam stop valve and its trip mechanisms

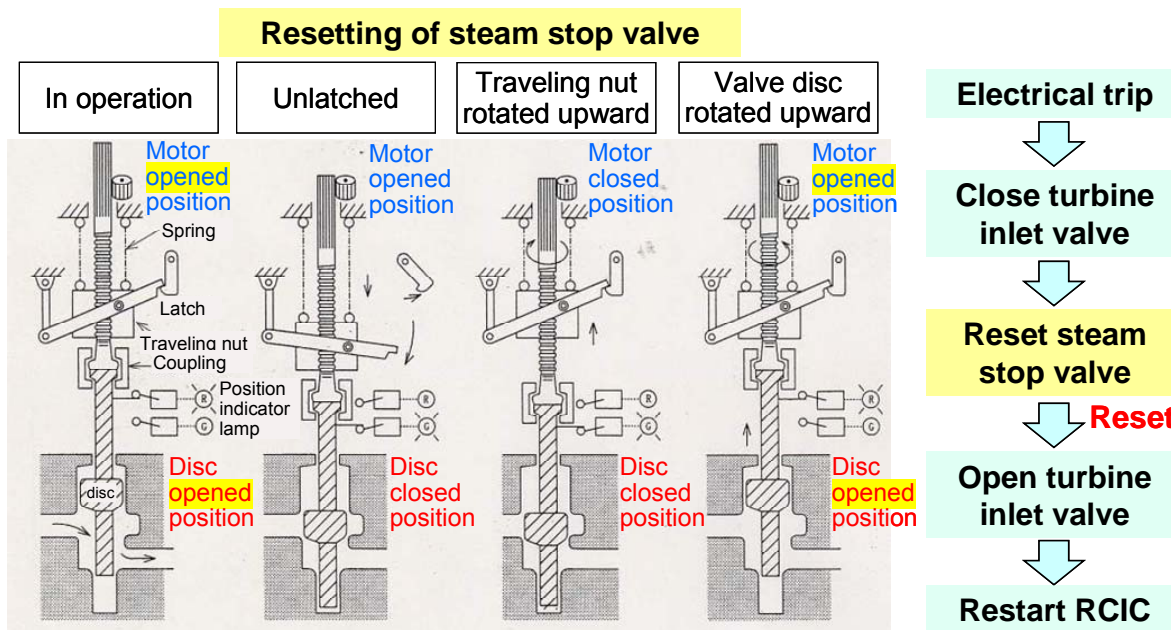

Figure 3 Schematics of RCIC turbine steam stop valve resetting

3. Conditions of DC power sources

Figure 4 shows schematics of DC power distributions and loads relevant to the RCIC and HPCI of Unit 3. Batteries and DC power supply panels of Unit 3 were not destroyed by the tsunami, since they had been installed in a sub-basement of the turbine building, differing from the situation of Unit 1 and Unit 2.

Figure 5 shows schematics of the in-service condition of DC power loads, while Table 2 gives the chronology of incidents and power supplies for each load. DC power required by the RCIC logic circuits and trip signals for electrical trips is supplied from the battery DC125-3A (Power Distribution Panel 3A-1). This DC power source for the electrical trips is considered to have been secured, when the RCIC tripped at 11:36 on March 12th, since the RCIC operation and its resetting, and the reactor water level monitoring had been controlled in the MCR, and no evidence of depletion of the battery DC125-3A had been noticed.

The capacity of battery DC125-3A (1200 AH in terms of a 10-hour discharge rate) was set in consideration for the following loads: instantaneous loads such as for starting up emergency diesel generators (DGs) upon loss of the external power source, for operating circuit breakers of power supply panels; and standing power loads for four-hour operations of RCIC, MCR control panels, and DC lighting devices. In reality, however, the RCIC could have been in operation for about 20 hours after the station blackout due to the tsunami had occurred. This is considered as having been made possible because the battery could have lasted without depletion until this time for the following reasons: having a design margin (the actual power consumption is less than the designed value), disconnecting non-essential DC lighting devices, avoiding RCIC trips due to high reactor water levels, etc.

But from the afternoon onward of March 12th, the battery DC125-3A is considered to have been unstable, indicating signs of depletion in vacuum pump trips, instrumentations becoming defunct, etc.

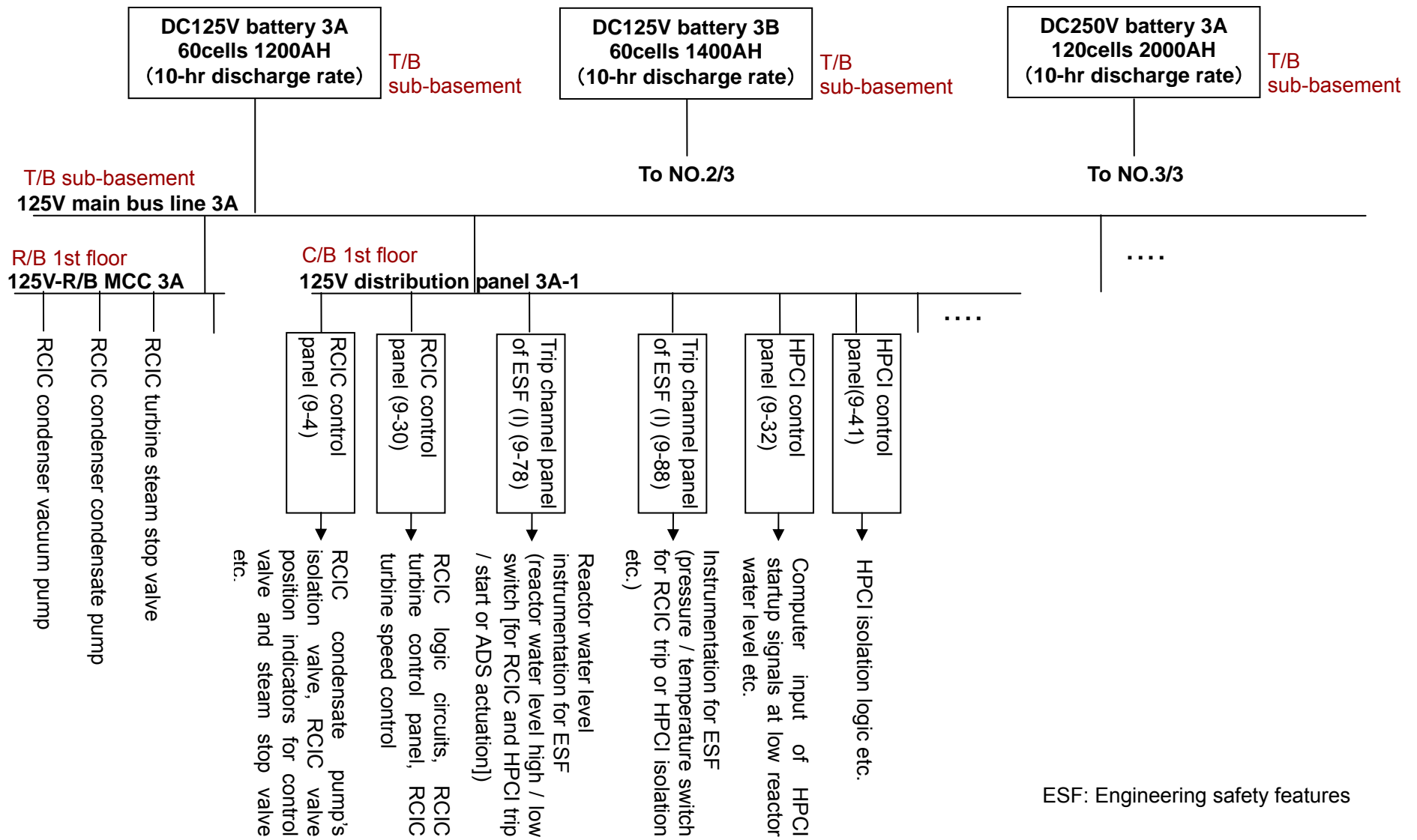

Figure 4 Schematics of DC power distributions and loads relevant to HPCI of Unit 3 (1/3)

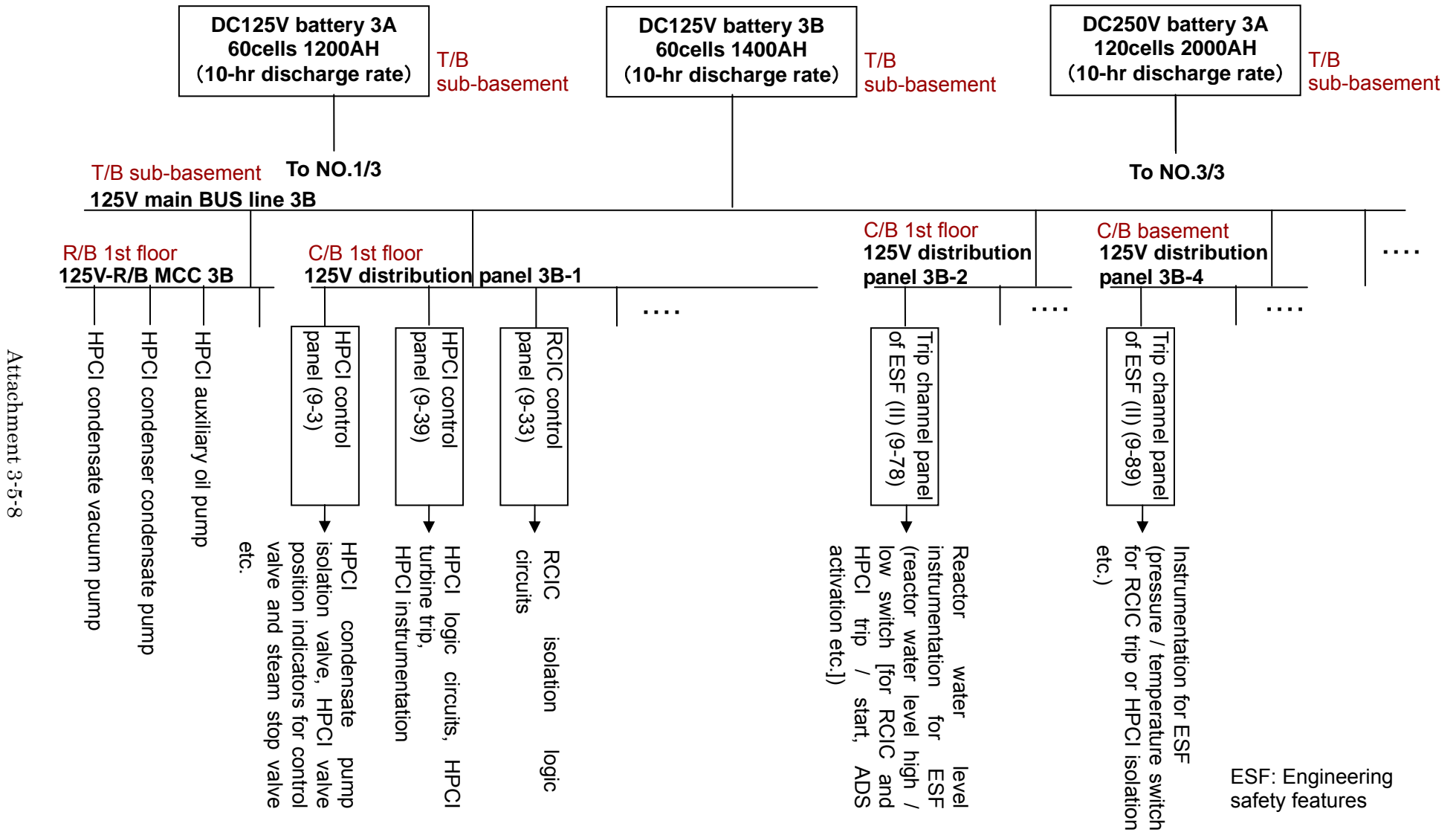

Figure 4 Schematics of DC power distributions and loads relevant to HPCI of Unit 3 (2/3)

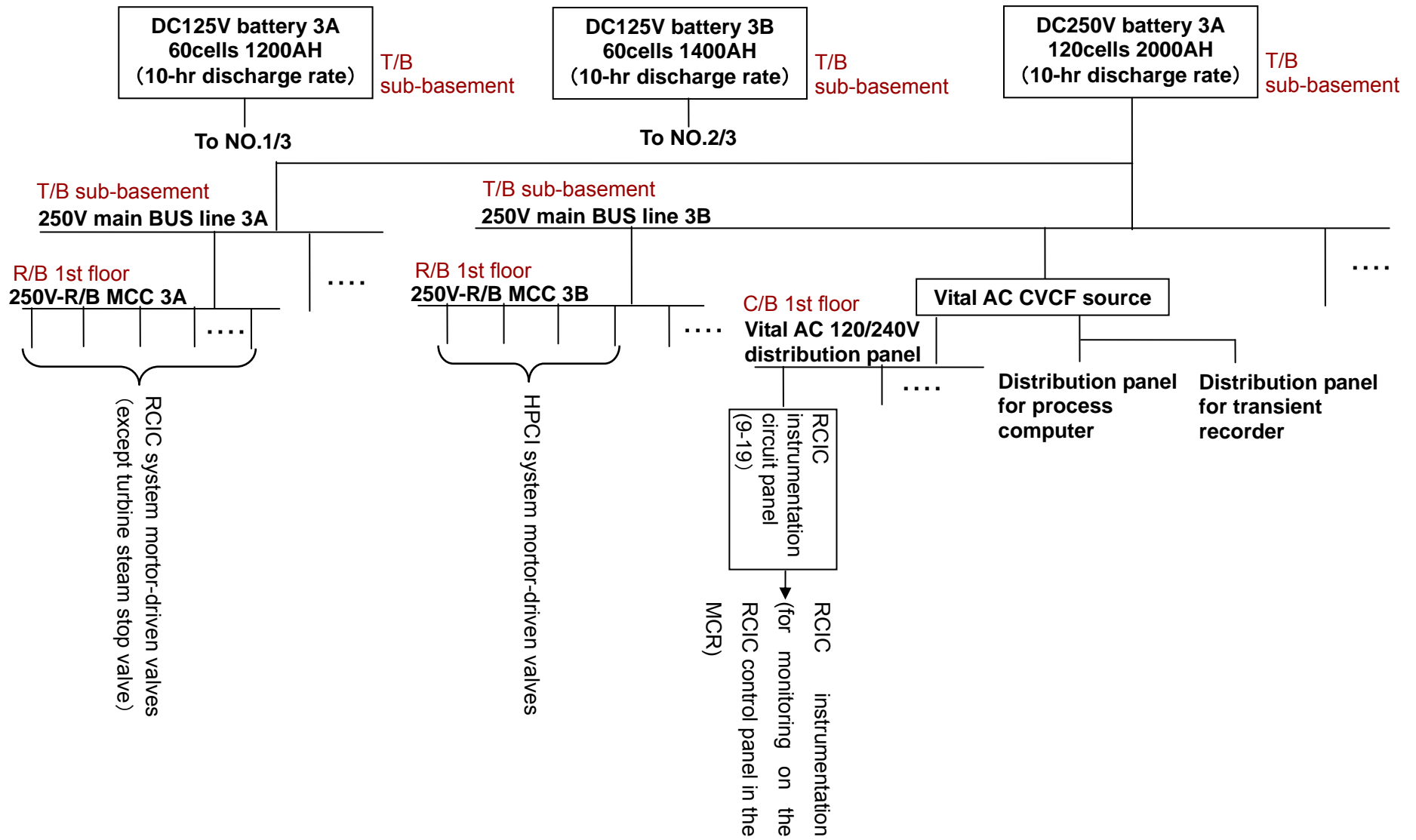

Figure 4 Schematics of DC power distributions and loads relevant to HPCI of Unit 3 (3/3)

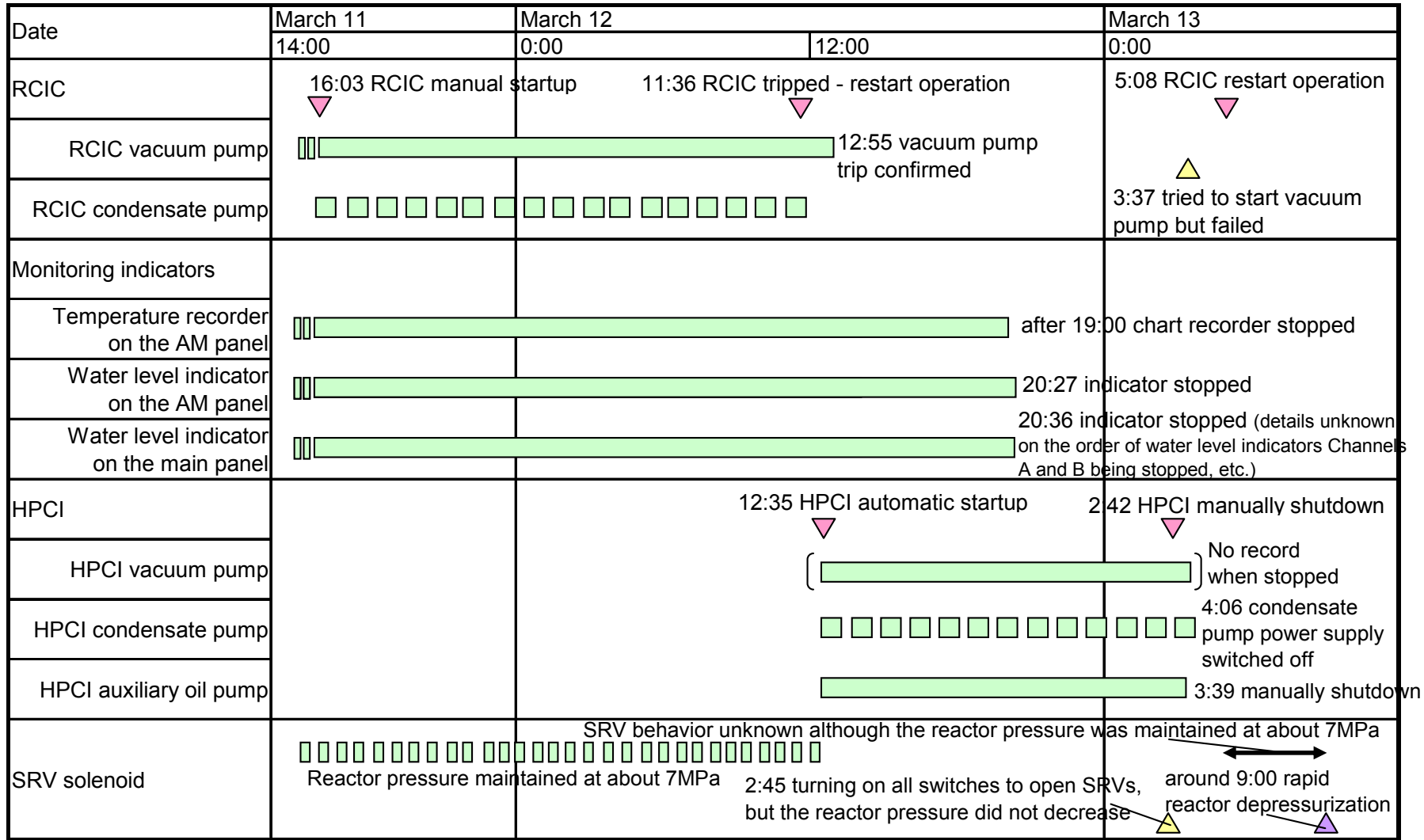

Figure 5 Schematics of DC power loads

Table 2 Chronology of incidents and power distributions to each load

Date Time	Incident	Battery DC125V-3A			Battery DC125V-3B			Battery DC250V-3A			Remarks or presumptions (X shows the power supply source to related load) PDP: Power distribution panel	
		Main bus line panel 3A			Main bus line panel 3B			Main bus line panel				
		MCC 3A	PDP 3A-1	PDP 3A-2	MCC 3B	PDP 3B-1	PDP 3B-2	MCC 3A	MCC 3B	Vital		
3/11 16:03	RCIC manual startup	X	X							X		
—	Flow control by FIC while monitoring relevant parameters in MCR										X	Unnecessary loads were disconnected from the vital power distribution panel except that for monitoring parameters relevant to RCIC.
3/12 11:36	RCIC automatically tripped		X ^{*1)}									
	RCIC flow rate/discharge pressure indicated 0										X	
—	RCIC resetting and restart attempted	X								X		
—	RCIC tripped immediately after restart		X ^{*1)}									^{*1)} No signs of DC power source depletion confirmed at this point. Voltage for electrical trip was considered to be secured.
3/12 12:35	HPCI automatic startup (low reactor water level)				X	X					X	
to 3/12 about 20:00	Monitoring indicators <ul style="list-style-type: none"> • PCV temperature chart recorder on AM panel • D/W pressure, S/C pressure and S/C water level indicators on AM panel • Reactor water level indicator (wide range, fuel range) 		X	X								As of 3/12 11:36, all indicators were working and no signs of DC power source depletion were confirmed. After 3/12 20:00, signs of DC power source depletion were noticed such as out-of-service indicators. DC power did not seem to have been stable.

Attachment 3-5-11

4. Examination of the cause of repeated shutdown

4.1 Possibility of electrical trips

It is highly possible that the RCIC was *not* tripped by mechanical overspeed, but electrically at 11:36 on March 12th, as seen in the afore-mentioned monitoring and operating situations in MCR and field observations, based on the following grounds.

- The turbine steam stop valve equipped with the trip mechanisms had been closed, tripping the RCIC;
- The operational procedures of turbine steam stop valve had been completed to the resetting procedure from the MCR panel; and
- DC power for RCIC operation and control had been available.

Figure 6 shows the interlock logic of RCIC electrical trips.

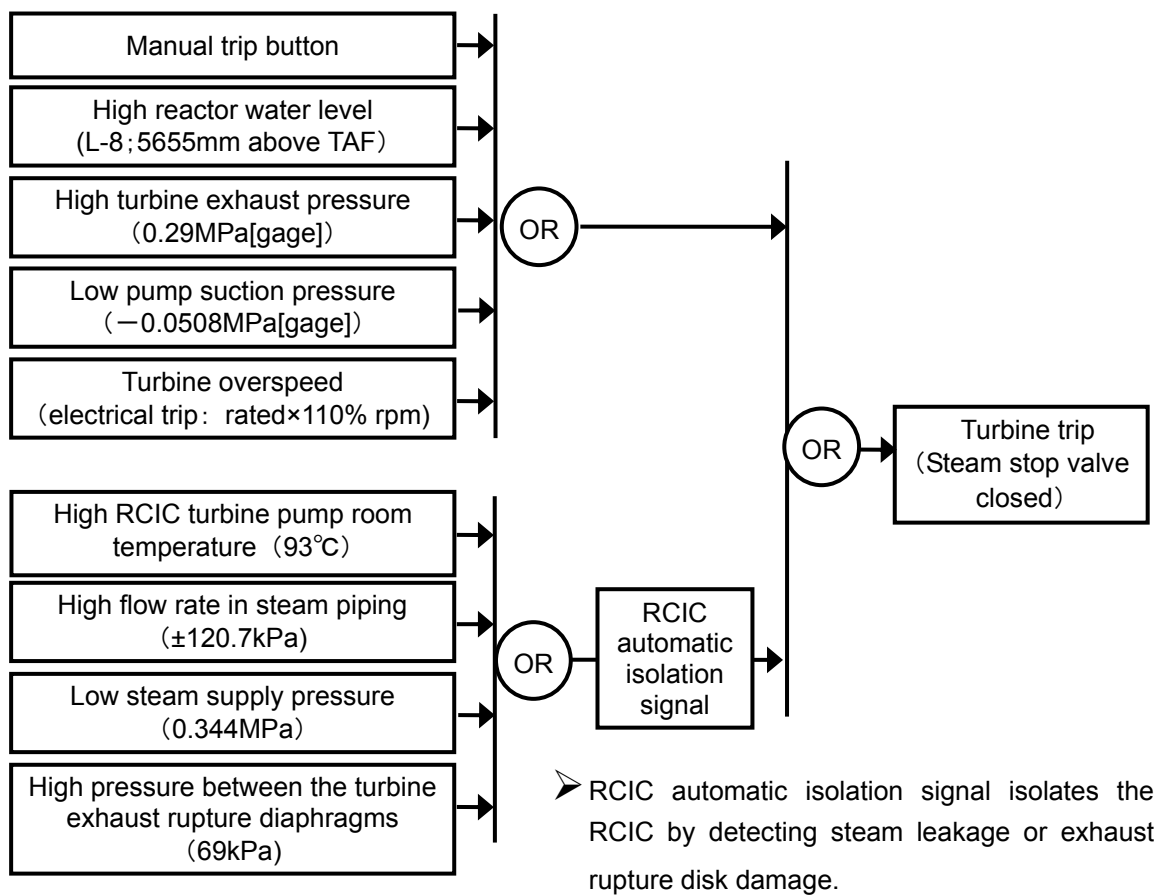

Figure 6 The interlock logic of RCIC electrical trips

The following subsections describe the feasibility conditions of each interlock logic, among which the highest likelihood is for high turbine exhaust pressure.

4.2 Possibility of high turbine exhaust pressure interlock working

Figure 7 shows the RCIC turbine exhaust pressure changes observed by the operators. Due to loss of heat removal functions, the exhaust pressure was increasing with the increase in both the D/W and S/C pressures, and as of 11:36 on March 12th, when the RCIC tripped, they were at a level very close to the preset high exhaust pressure trip level. The exhaust pressure reading was 0.25MPa[gage] as of 11:25 on March 12th, and had not reached the preset trip level (0.29MPa[gage]). Further, there is no record on the exhaust pressure at the very instant of the RCIC trip, and so no direct evidence of observation exists concerning the RCIC trip due to high exhaust pressure.

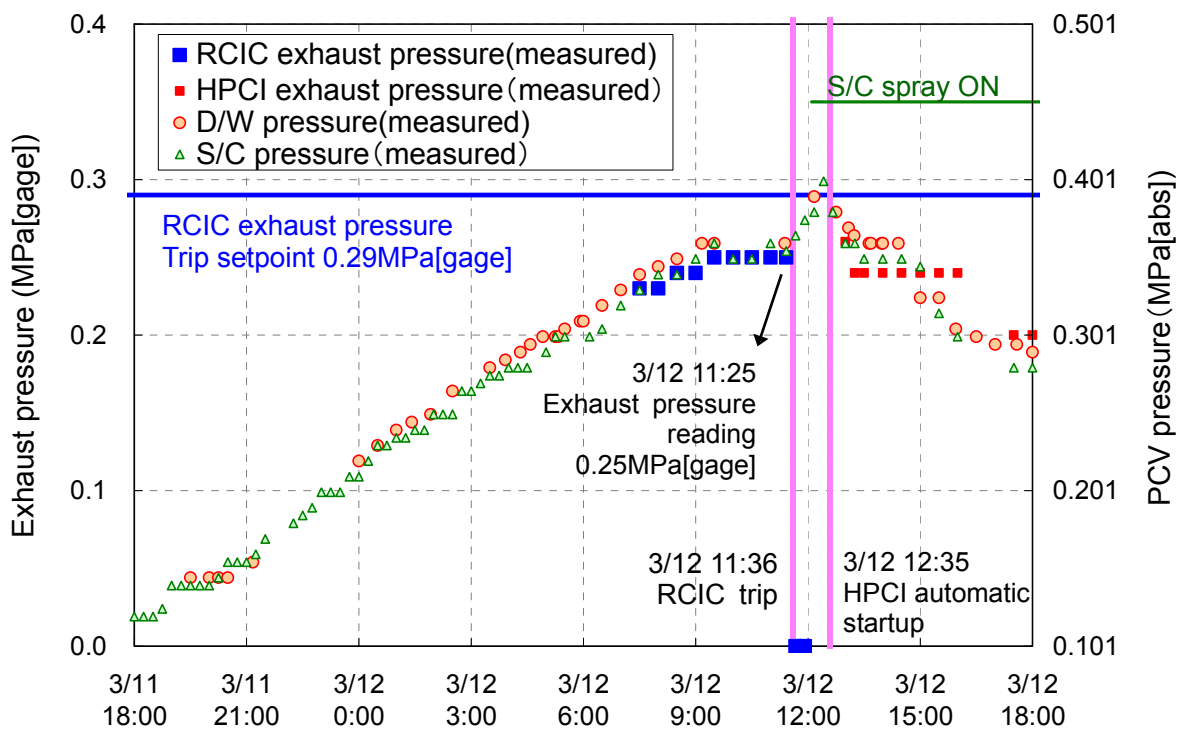

Figure 7 RCIC exhaust pressure change and PCV pressure change

It should be noted, however, that the D/W and S/C pressures showed an increasing trend again, after remaining stable at one level for almost 3 hours before the RCIC trip, in the particular circumstance in which the PCV pressure should have simply increased under the situation of no final heat sink. Consequently, it is possible to consider that the turbine exhaust pressure reached the trip level at 11:36 on March 12th, based on the following.

(1) Instrumentation accuracies

As is shown in Figure 8, exhaust pressure gauges for the MCR indicator and the logic circuit input are different, and about 0.02MPa difference could exist in these two instrumentations due to instrumentation accuracies and reading errors. Even taking these inaccuracies into account, the

pressure reading of 0.25MPa[gage] at 11:25 on March 12th is considered not to have reached the trip level (0.29MPa[gage]).

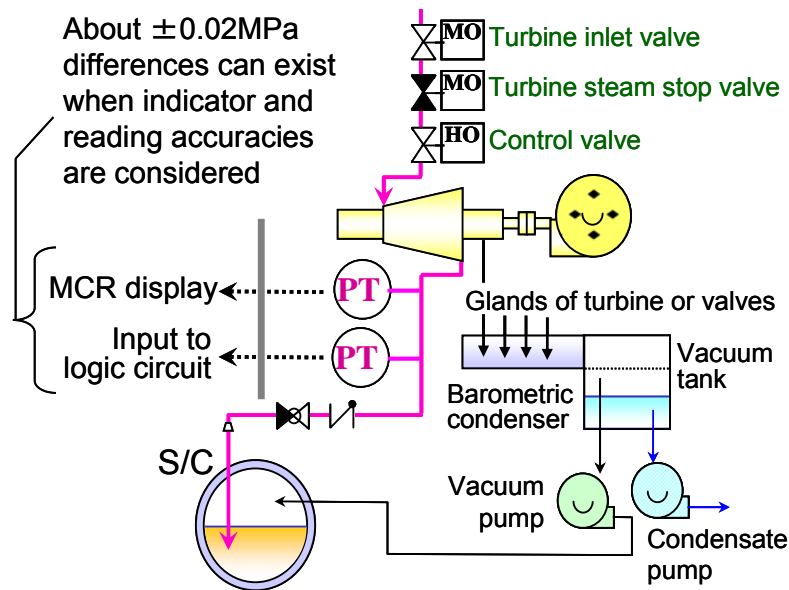

Figure 8 Positional illustration of RCIC exhaust pressure gauges

In the meantime, the D/W and S/C pressures increased from 11:25 through 11:36. According to the RCIC test operation that had been done during the scheduled maintenance, the turbine exhaust pressure under the reactor rated power condition (about 6.9MPa[gage]) was about 0.05MPa when the S/C pressure was atmospheric pressure. This represents the pressure loss in the turbine exhaust piping under rated power operation. The S/C pressure measured from 11:25 through 11:36 was about 0.36MPa[abs], and when 0.05MPa is added as the pressure loss, it reaches 0.41MPa[abs] (about 0.31MPa[gage]), exceeding the trip level.

It is considered, therefore, the turbine exhaust pressure might have reached the trip level when the D/W and S/C pressures increased from 11:25 through 11:36, although the exhaust pressure, at 11:25 on March 12th had not reached the trip level, but was close to it (0.29MPa[gage]).

(2) Explanation of the successful RCIC turbine resetting operation

As was shown in Figure 7, the turbine exhaust pressure reading was about 0MPa[gage] after the RCIC trip at 11:36 on March 12th. This is because the steam in the exhaust piping was condensed and because the S/C pressure (back pressure) was blocked by the check valve in the downstream side of the exhaust piping.

Concerning the incident of repeated trips of the RCIC upon steam injection in restarting attempts after successful resetting, it can be interpreted by the following scenario: If a trip is triggered by the high turbine exhaust pressure, the exhaust pressure on the indicator decreases, the trip condition is cleared once, and later upon steam injection the RCIC trips again due to the increased pressure.

On the other hand, the scenario is still unclear concerning the incident of D/W and S/C pressure changes, i.e., monotonously increasing upon loss of heat removal functions with no final heat sink, then staying once at a level from 09:30 through 11:25 on March 12th, and again starting to increase. At that time, the reactor steam was being released to the S/C via the SRV and RCIC, and the water inside the S/C was likely to have thermally stratified. The incident might have been caused by some unknown phenomena in the S/C.

4.3 Possibility of other interlocks working

Other interlock conditions are unlikely to be met, as discussed below.

<Manual trip>

No traces of this were confirmed, which indicates the manual scram button had been pushed.

<High reactor water level (L-8: TAF+5655mm)>

Figure 9 shows the chart record of reactor water level (narrow range) and Figure 10 shows the measured water level changes which operators read in the indicators. The RCIC flow rate was being controlled by the FIC while monitoring the reactor water level, and as of 11:36 on March 12th, when the RCIC tripped, the reactor water level had not reached the level L-8. An RCIC trip due to high reactor water level interlock is not possible.

<Low pump suction pressure (-0.0508MPa[gage])>

This could occur if the condensate storage tank water level decreased. But immediately after, the HPCI could have been started up and its operation continued (using the same trip signals). Further, if the tank water level really dropped below the preset trip level, the RCIC resetting operation would not have been successful. These are inconsistent with the facts as they are known.

<High turbine overspeed (electrical trip: rated x 110% rpm)>

It is unlikely that the overspeed trip occurred, since the DC power for RCIC control was available, and the steam control valve was functional while the operator was monitoring the reactor water level and controlling RCIC flow rate using FIC.

<Automatic isolation signal>

No records exist showing the status indicator lamp indicated the RCIC isolation valve closure. Further, the PCV isolation valve on the outer side was closed from the MCR at around 11:00 on March 13th.

Red: Reactor water level (narrow range)

Green: Reactor pressure (wide range)

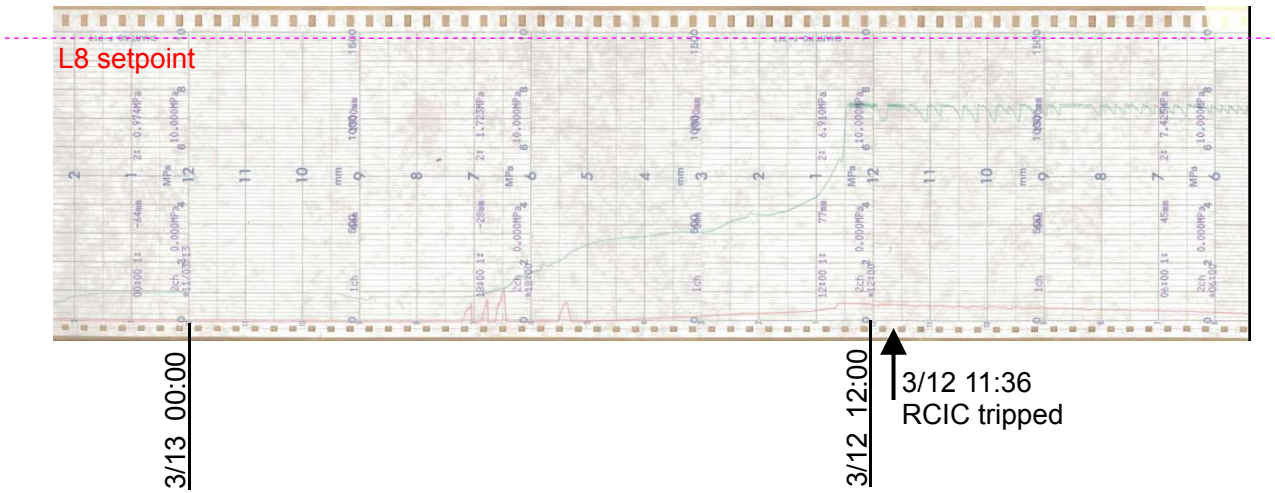

Figure 9 Chart record of reactor water level/pressure

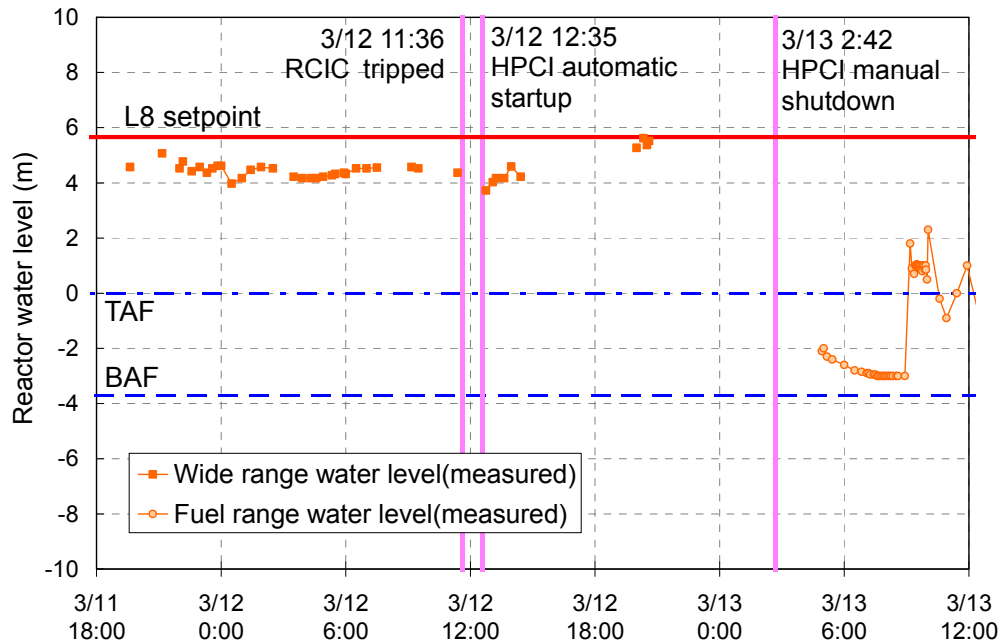

Figure 10 Reactor water level changes

5. Related countermeasures

In the development of tsunami accident management procedures under station blackout conditions for the Kashiwazaki-Kariwa Nuclear Power Station, a procedure to bypass the high RCIC turbine exhaust pressure interlock is being developed to continue water injection using the RCIC even when the S/C pressure increases. This is based on a concept to prioritize continuing the RCIC operation for flexibility even if the turbine exhaust pressure exceeds the trip level, since such an operation will not damage the RCIC equipment immediately.

The RCIC exhaust piping has a vent line equipped with a rupture disc for preventing

overpressurization. This is because the RCIC is designed so that its pressure is released when the RCIC rupture disc physically ruptures, if the RCIC turbine exhaust pressure continues to increase as the S/C pressure increases, and reaches the rupture disc working pressure. Practically, however, the S/C pressure is controlled, since the PCV is cooled by means of the PCV spray or PCV venting by alternative water injection lines (the pressure limit for PCV venting is set lower than the RCIC rupture disc working pressure).

There are other countermeasures, too, for strengthening high pressure water injection functions, and some examples are listed below.

- Reinforced DC power source (capacity intensification, elevated positioning).
- Additional installation of a high pressure alternative cooling system (HPAC).
- Development of local RCIC manual startup operating procedures upon loss of all AC and DC power sources.

6. Summary

It is highly possible that the RCIC was *not* tripped by mechanical overspeed, but was electrically tripped at 11:36 on March 12th, based on analysis of the monitoring and operating situations in the MCR and field observations, for the following reasons.

- The turbine steam stop valve, equipped with trip mechanisms, had been closed, tripping the RCIC.
- The operational procedure of the turbine steam stop valve had been completed to the resetting procedure from MCR panel.
- DC power for RCIC operation and control had been available.

Among possible interlock conditions for electrical trips, the one with the highest likelihood was for the high turbine exhaust pressure. As of 11:25 on March 12th, the turbine exhaust pressure reading was 0.25MPa[gage], and below the preset trip level (0.29MPa[gage]). But the D/W pressure and S/C pressure were increasing after remaining stable at one level before the RCIC trip, and it was possible, from the following, that the turbine exhaust pressure reached the trip level at 11:36 on March 12th, the time of RCIC trip.

- When the pressure loss in the RCIC exhaust piping was added to the S/C pressure reading, the turbine exhaust pressure would be at the level exceeding the trip level. Therefore, the turbine exhaust pressure had to be close to the trip level.
- It was possible that the turbine exhaust pressure reached the trip level when the S/C pressure increased from 11:25 through 11:36 on March 12th.
- It was possible to interpret the incident development as that the RCIC resetting could be done (the trip condition was cleared once), but it tripped immediately afterward upon steam release again.

- Other interlock conditions were unlikely to be met.

(End)