

Water level and temperature changes in the suppression chamber (S/C) of Unit-2

1. Introduction

Attachment 2-8 clarified the possibility of a leak hole being present in the lower part of the S/C. The survey conducted in January 2014 confirmed that the levels of retained water in the torus room and the water in the S/C pool were changing consistently because the two levels were changing roughly the same. Attachment 2-8 also indicated that the S/C thermometer readings changed according to whether the S/C thermometer was covered by the S/C pool water or not due to the changing S/C water levels. This document furthers the examination in Attachment 2-8 concerning the mechanism of the measured S/C gaseous temperatures and pool water temperatures changing due to the S/C water level changes, and it also examines a scenario based on the actual data obtained to date by calculating the S/C water level changes and evaluating the influences of these water level changes on the S/C thermometer readings. Finally, this document estimates the location of the leak hole, which has been considered to be near the bottom of the S/C.

2. Dependence of heat inflow to the S/C on the relation between the elevation of the vacuum breaker leak path and the S/C water level

Attachment 2-8 estimated that steam leaks were progressing even when the S/C water level was above the lower end of the downcomer and below the S/C thermometer, since the S/C gaseous temperatures were high enough. During March 2011, the D/W atmospheric temperatures were elevated and steam carried heat from the D/W to the S/C, but after September 2011 the temperatures in the RPV and PCV decreased below 100 deg C and the heat inflow to the S/C was considered to have been by the overflow of water that had been retained in the D/W. Figure 1 shows a cross-sectional view of the S/C, while Figure 2 shows a photo of the vacuum breaker valve.

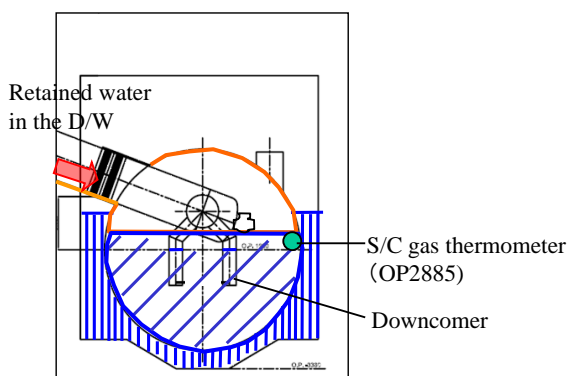

Figure 1 Cross-sectional view of S/C internal

Figure 2 Vacuum breaker valve

Refer to Chapter 9 of the Main Body of Progress Report for the usage of O.P.

2.1. Heat outflow from S/C

The S/C was located in the lowest floor of the reactor building (R/B) (Figure 3) and part of the heat of the S/C water was transferred to the gaseous phase from which it was further transferred to the outside through the S/C walls. Most of the heat was considered to be transferred to the water retained in the torus room through the S/C walls (under water), and further to the outside through the R/B exterior walls (Figure 4). Dominant cooling surfaces were the walls and floors of the R/B lowest floor and therefore the heat outflow from the S/C was directed from the upper part to the lower part. Consequently, the temperature gradient was formed as “high at the top of the S/C pool water and the retained water in the torus room” and “low toward the bottom.” Figure 5 shows the heat flow.

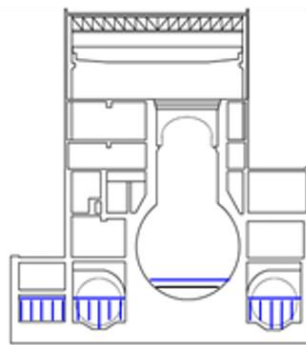

Figure 3 Cross section of the reactor building

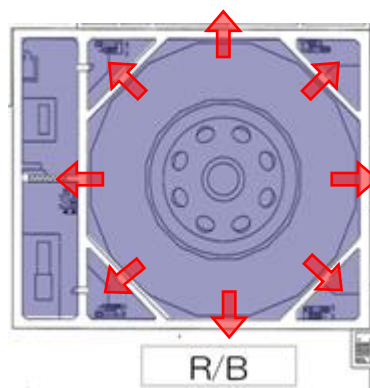

Figure 4 Basement floors of reactor building

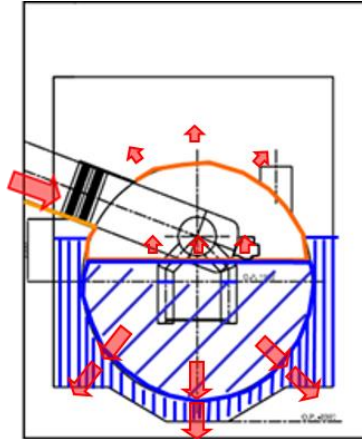

Figure 5 Heat flow estimated in the S/C

2.2. Heat inflow to the S/C

The water retained in the D/W and having overflowed therefrom stayed a while at the bottom end of the vent tube (Location A) as shown in Figure 6. There were two possible paths thereafter from Location A to inside the S/C: the first was the original path through the inverse-U type downcomer; and the second was the path through a leak hole caused in the vacuum breaker valve for unknown reasons. The flow rates through these paths were considered to be different depending on the S/C water level.

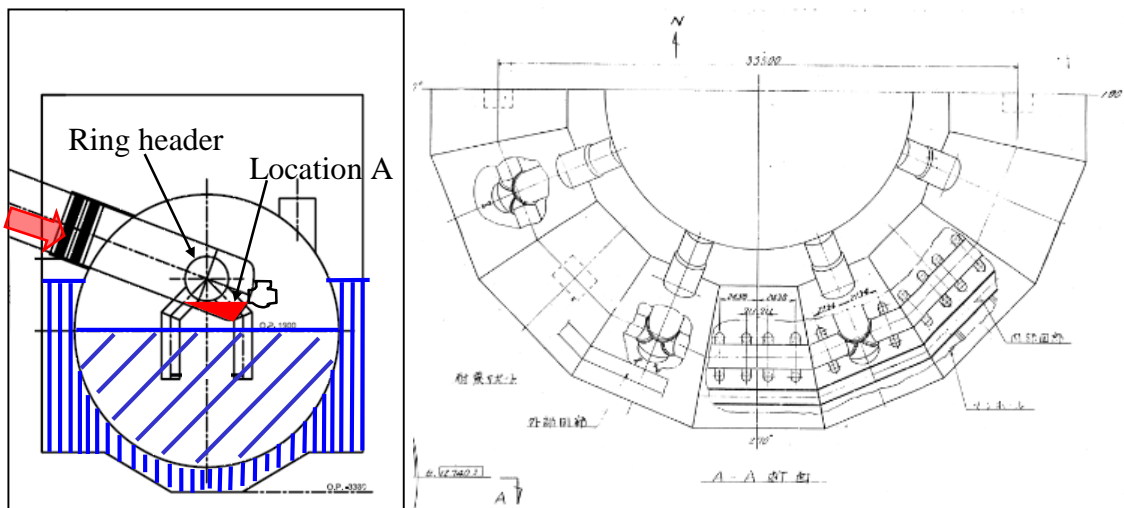

Figure 6 Location of the vent tube bottom end

2.2.1. When the S/C water level is above the leak hole elevation in the vacuum breaker valve

Two flow paths can be considered for the water retained in the D/W and having overflowed therefrom to be transferred to inside the S/C after staying at Location A. The upper path ① is the path through the leak hole in the vacuum breaker valve. The lower path ② takes a route from the bottom end of the vent tube to an annulus type ring header, which is connected to the vent tube,

and to the entry point at the lower part of S/C via the downcomer.

The flow rates of the upper path ① and lower path ② are quite different, because of a big difference in S/C water temperatures (hence water densities) at the entry point of the retained water into the S/C. The warm and low density retained water is stored once at Location A when it overflowed from the D/W, and after a while it is transferred to the S/C by being pushed out from Location A by the newly incoming water retained from the D/W. The amount of transfer strongly depends on the difference of densities, i.e., the amount of flow via upper path ① through the upper leak hole (water with less temperature difference and less density difference from the water at the entry point of the S/C) dominates the amount of flow via lower path ② (water outflow by pushing out the S/C water with lower temperature and thus larger density).

Consequently, the vertical temperature profile of S/C water becomes such that the temperature is high from the S/C pool surface to the elevation of the leak hole in the vacuum breaker valve and tends to become lower toward the bottom.

2.2.2. When the S/C water level is below the elevation of the leak hole in the vacuum breaker valve

The water retained in the D/W and having overflowed therefrom is stored at Location A and then supplied to the entry point at the lower part of the S/C via the ring header and downcomer, differing from 2.2.1 above. The water supplied from the bottom end of the downcomer is warmer than the surrounding water, causing it to move upward and then downward after the heat release, generating water circulation by natural convection. Consequently, the temperatures from the S/C water surface to the bottom end of the downcomer (OP325) are homogenized by the water circulation, and below the bottom of the downcomer the temperature becomes lower in the direction toward the bottom of the S/C. When the S/C water level is lower than that of the S/C thermometer (OP2885), the thermometer detects the gaseous temperature, which is slightly lower than the temperature of the S/C water surface, because the gaseous phase releases heat to the torus room.

2.3. S/C water level and S/C temperature field

The relations between the S/C water level and the temperature profile in the S/C in Sections 2.2.1 and 2.2.2 are as illustrated in Figure 7. It should be noted that the leak hole in the vacuum breaker valve is considered to be between the bottom end of the valve element (OP2850) and the upper end (OP3283) but that it is assumed to be at OP2885 in the discussion in the following Section 3 dealing with the relations between the S/C water level and the temperature profile in the S/C.

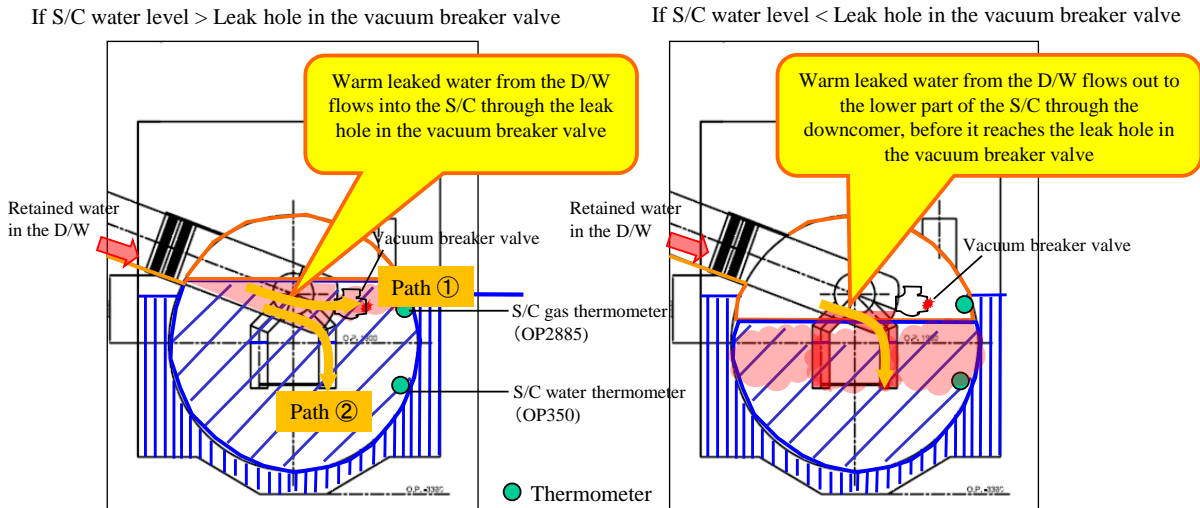

Figure 7 Difference in water inflow conditions depending on the S/C water level

3. Deliberation on S/C temperature changes by means of S/C water level evaluation

Next, the S/C water level changes were quantitatively evaluated by a calculation model for investigating the relationship of S/C water levels and water temperatures based on the deliberations in Section 2.3.

3.1. S/C water level calculation model

Figure 8 illustrates the principles and specifications of the calculation model. The S/C water level is calculated by the amount of water in the S/C based on the mass conservation law, while the time changes are calculated using the difference method.

Equation ①: The amount of S/C water at Step $n+1$ is the sum of the amount at Step n and the amount added during Step n .

Equation ②: The amount added during Step n is the difference between the amount of inflow to the S/C and the amount of outflow from the S/C. The amount of inflow to the S/C is assumed to be equal to the amount injected into the reactor.

Equation ③: The amount of outflow from the S/C in Equation ② is obtained by Torricelli's formula. The flow rate is proportional to the leak area and leak velocity, and the leak velocity is determined by the elevation difference between the S/C pool and the retained water in the torus room and the gaseous pressure difference in and out of the S/C.

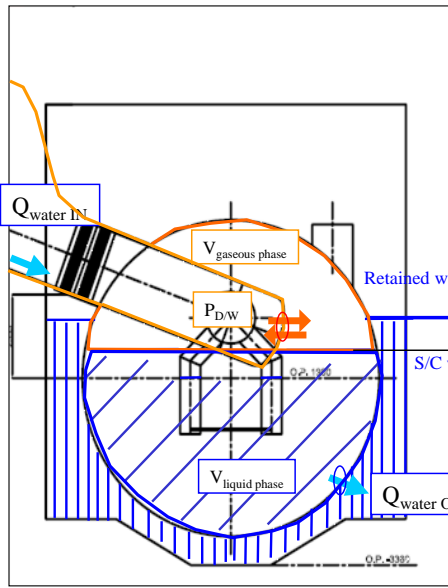

【Basic approach】

Calculate time changes of mass balance of the S/C water

【Equations】

①: $Q_{S/C\ water,n+1} = Q_{S/C\ water,n} + \Delta Q_{S/C\ water,n}$

②: $\Delta Q_{S/C\ water,n} = Q_{water\ IN,n} - Q_{water\ OUT,n}$

③: $Q_{water\ OUT,n} = C \times S \times \sqrt{2(P_{S/C,n} / \rho + g(H_{S/C,n} - H_{RW,n}))}$

C : Outflow resistance(0.62)

S : Leak hole area

$Q_{S/C\ water,n}$: Amount of S/C water at time n

$Q_{water\ IN,n}$: Amount of inflow to S/C at time n
= Amount of water injected

$P_{S/C,n}$: S/C pressure at time n

$H_{S/C,n}$: S/C water level at time n

$H_{RW,n}$: Retained water level at time n

Figure 8 Outline of S/C water level calculation model

In the calculation, the S/C pressure is corrected as D/W pressure $-2kPa$, based on the correlation measured between the S/C pressure and D/W pressure [1]. However, when the S/C water level exceeds the elevation of the vacuum breaker valve, the S/C gaseous phase becomes a closed space in a compression process and its pressure is calculated by Boyle's law of $PV=constant$ (Figure 9).

i If S/C water level > vacuum breaker valve

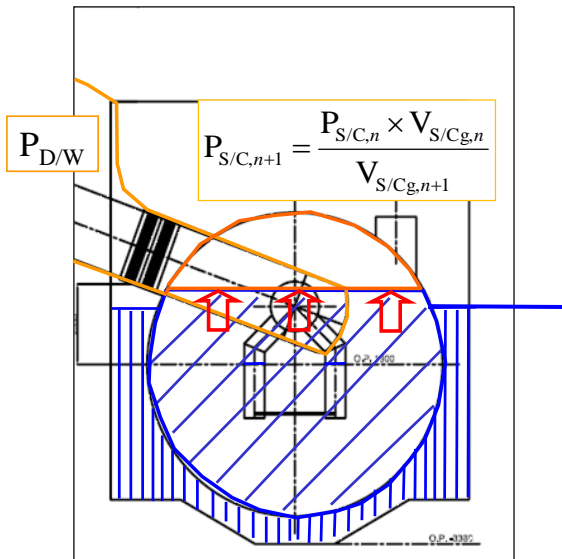

The gas in the S/C gaseous phase has no leak path to the D/W and is compressed and controlled by Boyle's law.

$V_{S/Cg,n}$: The S/C gaseous phase volume at time n

ii If S/C water level < vacuum breaker valve

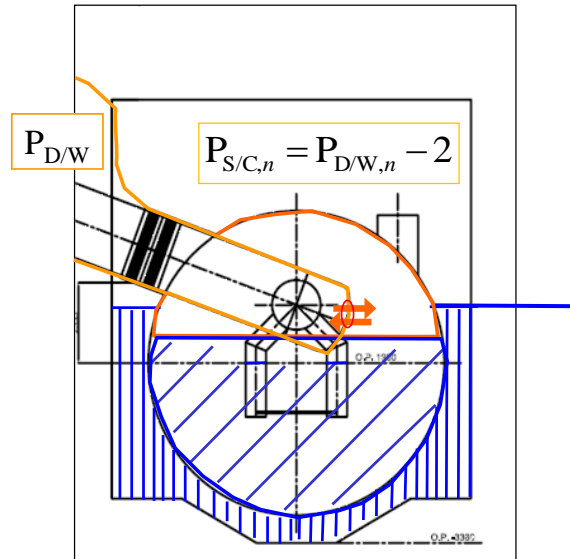

The S/C gaseous phase exchanges gases with the D/W gaseous phase through the leak hole. S/C pressure = D/W pressure $-2kPa$. " $-2kPa$ " was set based on the actual values when the S/C pressures had been measured.

Figure 9 S/C pressure calculation steps

The S/C water level to determine ΔH uses its calculated values, while the retained water level in the torus room uses the measured values. The initial condition of S/C water level is set so that the calculated S/C water level does not show extreme changes at the beginning time steps.

The characteristics to note in the current calculations are that all boundary conditions other than the above-mentioned S/C initial water level use measured values. The unknown parameter is only the S/C leak area.

3.2. S/C water level calculation results

Figure 10 shows the calculation results, which used the initial conditions at 01:00 on July 16, 2011, when the necessary data for calculations had been most abundant. The leak area was set at 9cm^2 .

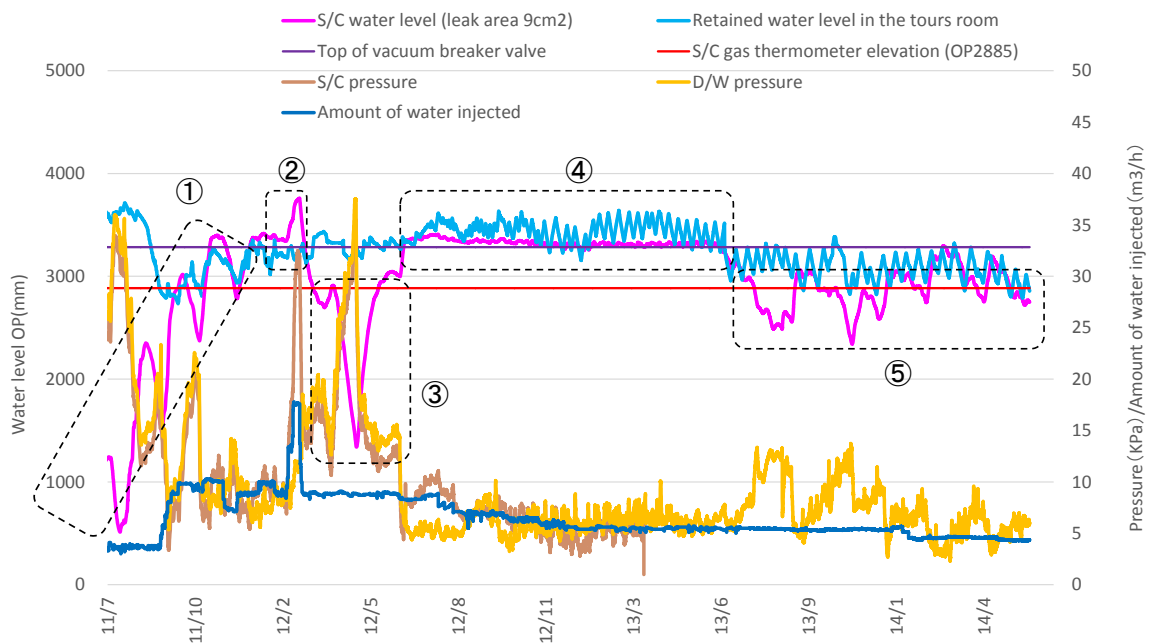

Figure 10 S/C water level (Leak area 9cm^2)

The S/C water level calculated was changing with changes of the D/W pressure, the retained water level and the amount of injected water.

① [When the D/W pressure was decreasing]

From July to December 2011, the S/C pressure decreased and the S/C water level increased consistently with the D/W pressure decrease.

② [When the injected water was increasing]

In early February 2012, the amount of water injection was increased as a measure for unstable thermometer readings (later these were found to have been due to a defective thermometer [2]).

This increased the S/C water level far above the vacuum breaker valve, the S/C pressure far exceeded the D/W pressure and the S/C gaseous space turned into a compressive space.

③ [When the D/W pressure was increasing]

The increased D/W pressure pushed a big amount of S/C water out to the torus room (to the side of retained water) and decreased the S/C water level. As the D/W pressure increase was resolved, the S/C water level was quickly recovered.

④ [When the retained water level was above the top of the vacuum breaker valve]

The retained water level in the R/B changed at a high elevation OP3200 to OP3500. When the S/C water level exceeded the elevation of the vacuum breaker valve, the S/C gaseous space was compressed, the S/C pressure increased, and the outflow from the S/C and the inflow to the S/C was balanced by the increased amount. Consequently, the S/C water level stayed roughly at the elevation of the top of the vacuum breaker valve.

⑤ [When the retained water level was below the top of the vacuum breaker valve]

The retained water level was lower than the vacuum breaker valve and the S/C water level changed violently due to changes of the D/W pressure. When the D/W pressures increased in July and October 2013, the S/C water level decreased, and when the D/W pressure increase was resolved, the S/C water level increased to roughly the retained water level. During this period, the S/C gas thermometer (located at OP2885) readings were observed to be changing violently. This behavior is estimated to have been caused by a repeated cycle of the S/C thermometer being immersed in the water or uncovered.

3.3. Relation between the S/C behavior and S/C temperatures as a function of the leak area assumed in the S/C

Figure 11 compares the S/C water level changes for different leak area of 6cm², 9cm² and 12cm² at the lower part of the S/C.

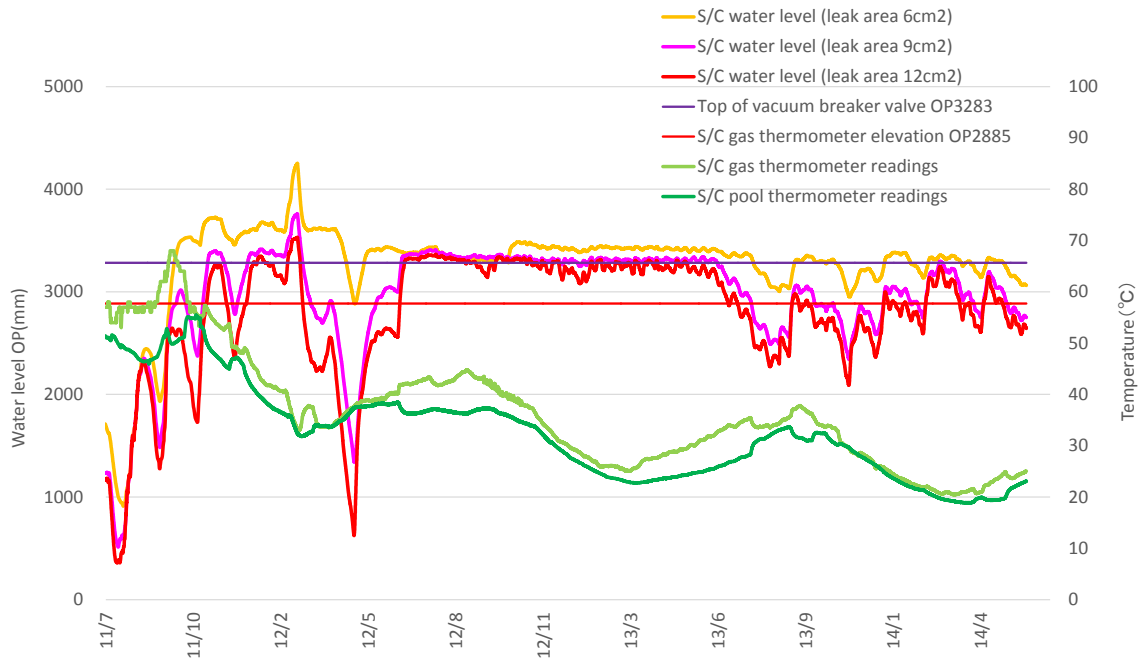

Figure 11 S/C water level changes for different leak area

The S/C water level showed different behavior depending on the leak area assumed. When the leak area was smaller, the S/C water faced higher resistance to leak out, and the water level was balanced at a higher elevation. The timings of the S/C thermometer being immersed in the water or uncovered differed depending on the leak area assumed. This section evaluated the effect of the S/C water level difference on the S/C temperatures mentioned in Section 2.3 above. Three leak area of 6cm^2 , 9cm^2 and 12cm^2 were assumed during period ⑤ [the retained water level was lower than the top of the vacuum breaker valve] between June 2013 and June 2014. It was checked whether the S/C gaseous temperatures and the S/C pool water temperatures had shown a change in measurement values at the timings when the calculated S/C water level had exceeded or dropped below the elevation of the S/C thermometer position (OP2885).

3.3.1. When the S/C leak area of 6cm^2 was assumed

Figure 12 presents the S/C water level calculated with a leak area of 6cm^2 and the temperatures measured at the S/C gaseous phase and the S/C pool water.

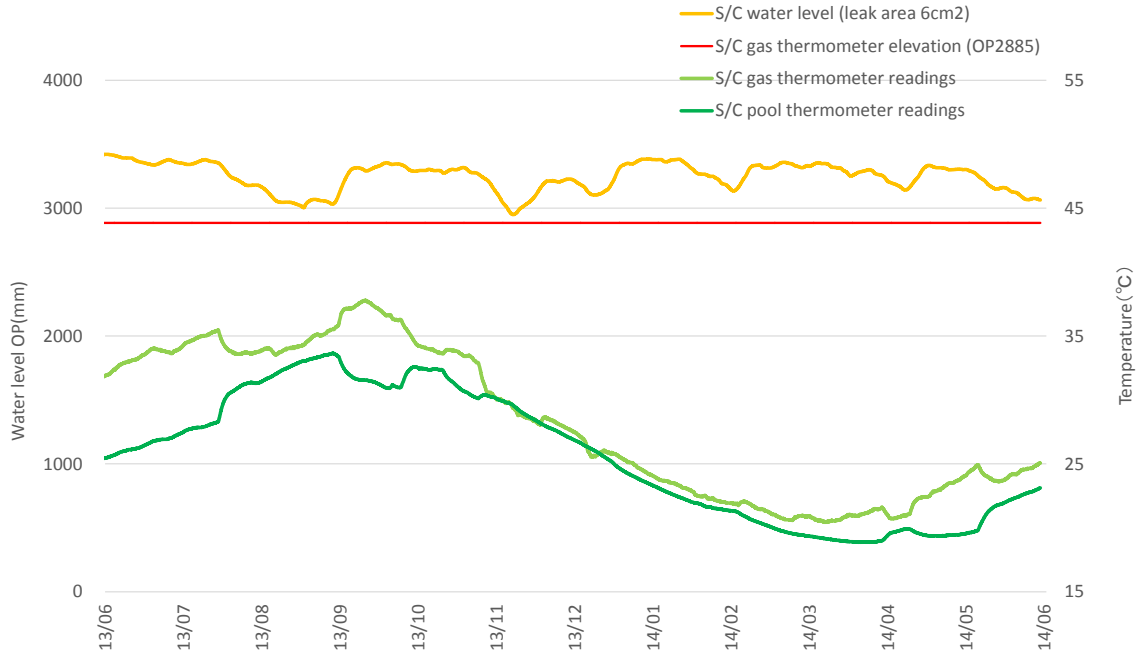

Figure 12 S/C water level calculated with the leak area of 6cm²

The calculated S/C water level always exceeded OP2885, the elevation of the S/C gas thermometer. In this case, no changes in the relationship between the S/C gaseous temperatures and pool water temperatures are expected, since there was no change in the condition of the S/C gas thermometer whether immersed in the water or uncovered, and in the heat flow paths. But this is not consistent with the reality.

3.3.2. When the S/C leak area of 9cm² was assumed

Figure 13 presents the S/C water level calculated with a leak area of 9cm² and the temperatures measured at the S/C gaseous phase and the S/C pool water.

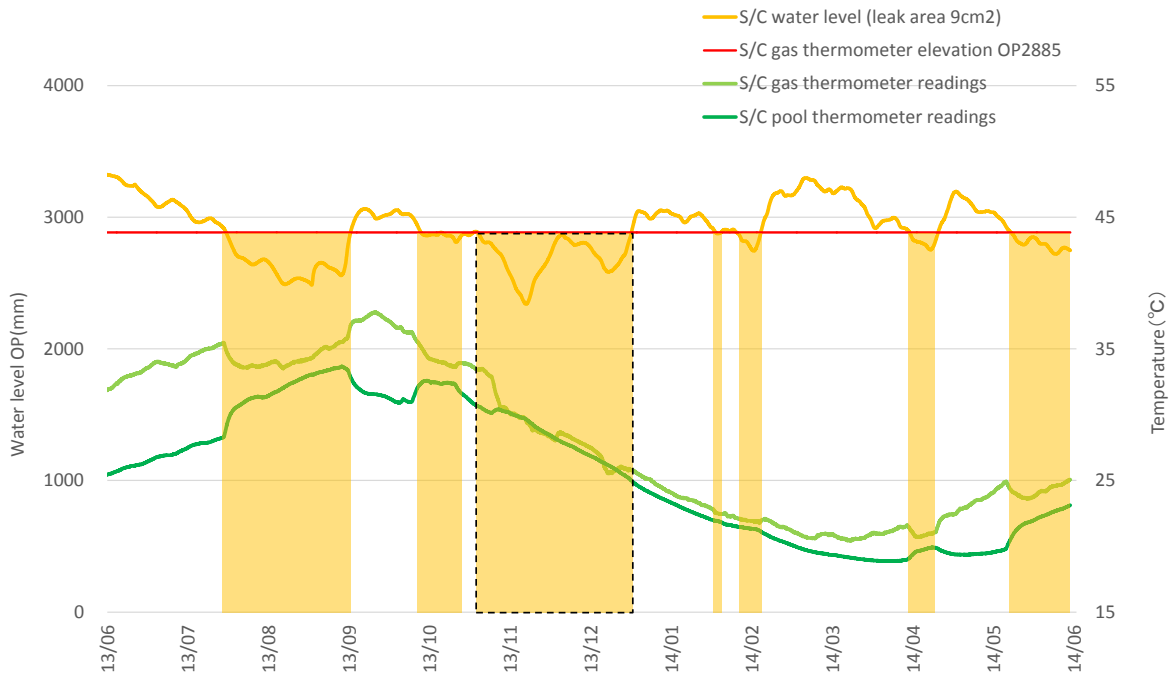

Figure 13 S/C water level calculated with the leak area of 9cm²

The S/C water level repeatedly shifted above and below the elevation of the S/C gas thermometer (OP2885). The orange-colored part shows the period when the calculated S/C water level was below the elevation of the S/C gas thermometer. As was seen in the deliberation of Section 2.3, the S/C thermometer readings showed a decrease because the thermometer tended to be exposed to the gaseous phase at the timing of the S/C water level change from above OP2885 to below it. The S/C pool water temperatures, on the other hand, increased for the following reasons: the heat flow from the bottom end of the vent tube to the upper position in the S/C pool water via the leak hole in the vacuum breaker valve changed to the path below through the downcomer; the pool water temperature increased by increased heat inflow around the liquid phase thermometer; and consequently, the temperature difference decreased between the S/C gaseous temperatures and pool water temperatures. During the orange-colored periods, the S/C gaseous temperatures and pool water temperatures showed a tendency for the temperature difference to decrease. The calculated S/C water level changes were consistent with the temperature changes.

It should be noted that there could have been some errors in the calculated S/C water level during the period enclosed by the dotted line rectangle (from October 16th to December 21st, 2013), when the water level changes and temperature changes were not in consistent agreement. This is because the pressure on the S/C water surface might have been affected by an operation to inject nitrogen gas directly into the S/C gaseous phase from October 16th to November 11th, 2013, as part of a purging operation of hydrogen gas that had been retained in the S/C gaseous phase.

3.3.3. When the S/C leak area of 12cm² was assumed

Figure 14 presents the S/C water level calculated with a leak area of 12cm² and the temperatures measured at the S/C gaseous phase and the S/C pool water.

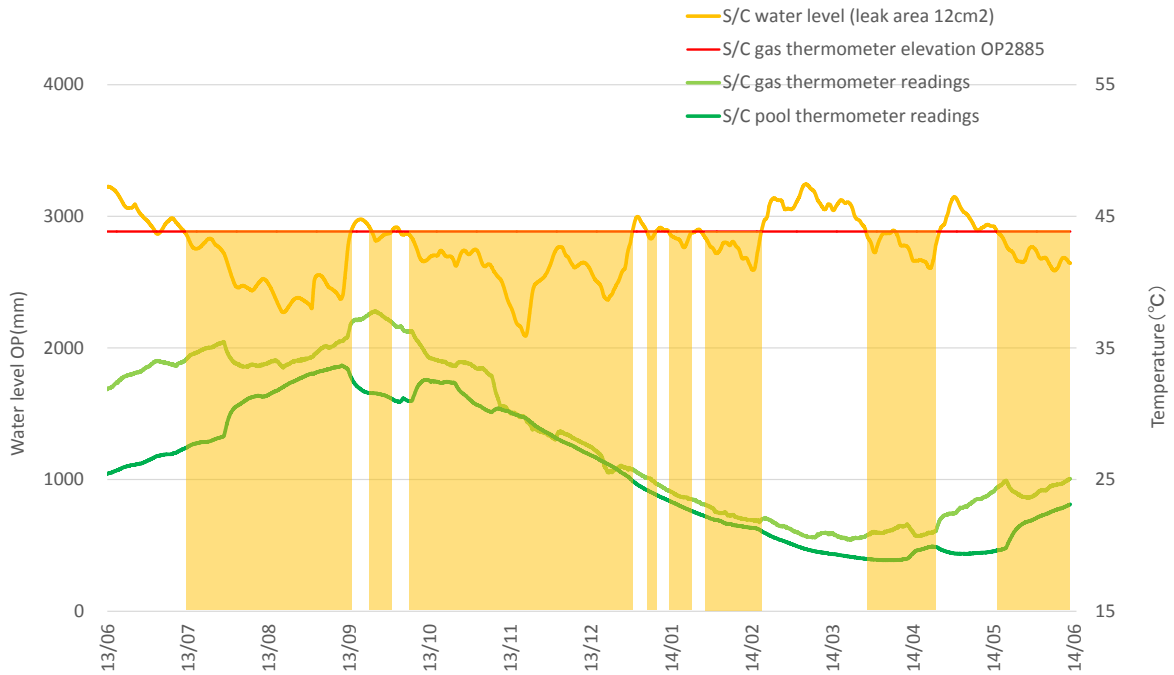

Figure 14 S/C water level calculated with the leak area of 12cm²

The calculated S/C water level changed violently, the S/C water level fell below the elevation of the S/C gas thermometer more often and inconsistency was noticed more often between the S/C temperature changes and water level changes, when compared with the results of the leak area of 9cm². Furthermore, inconsistency was also noticed between the timings when the S/C water level was below OP2885 and when the temperature difference of the measured S/C gas temperatures and the S/C pool water temperatures decreased. These findings do not represent the reality.

3.4. S/C water level variation range and S/C leak hole position

From the calculations in Section 3.3 above, the timings of temperature changes due to the S/C water level changing across the elevation of OP2885 and the timings of the measured S/C gas and water pool temperature difference being reduced can be considered to be in best agreement when the leak area of about 9cm² is assumed.

Figure 15 shows the S/C water level variation range if the leak area is 9cm².

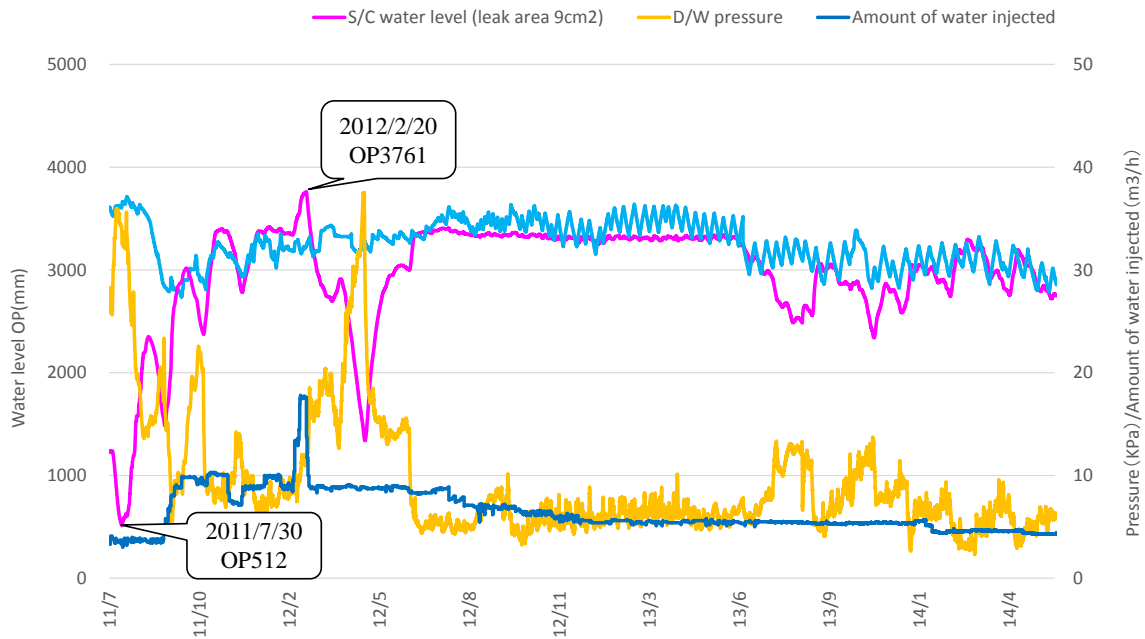

Figure 15 Maximum and minimum S/C water levels for the leak area of 9cm²

Between July 16th, 2011, and June 1st, 2014, the lowest S/C water level was evaluated as OP512 on July 30th, 2011. This was the time when much S/C water was pushed out by high D/W pressures. The highest S/C water level was evaluated as OP3761 on February 20th, 2012. This was thought to be because a big amount of water overflowed to the S/C by increased water injection and the S/C water level increased exceeding the elevation of the vacuum breaker valve. The S/C water level variation range over the whole period was from OP512 to OP3761. This indicates that the leak hole is located below this level.

4. Structures of S/C pipe penetrations of Unit-2

Table 1 lists the S/C pipe penetrations present below OP512, the lowest point of the S/C water level variation range when the leak area of 9cm² was assumed. Their structures are shown in Figure 16, namely, the pipe lines connected to the S/C which might include the leak hole are drain stoppers, pump suction lines of RCIC, RHR, HPCI and the core spray system, and pneumatic lines for driving the vacuum breaker valve.

Table 1 S/C pipe penetrations below OP512 of Unit-2

Penetration ID	Quantity	Name	Elevation
X-213A,B	2	Drain stoppers	OP2550
X-224	1	RCIC pump suction line	OP960
X-225A,B	8	RHR pump suction line	OP1745
X-226	1	HPCI pump suction line	OP1745
X-227A,B	2	Pump suction lines of core spray system	OP1745
X-229A to H, J to M	12	Pneumatic lines for driving the vacuum breaker valve	OP19

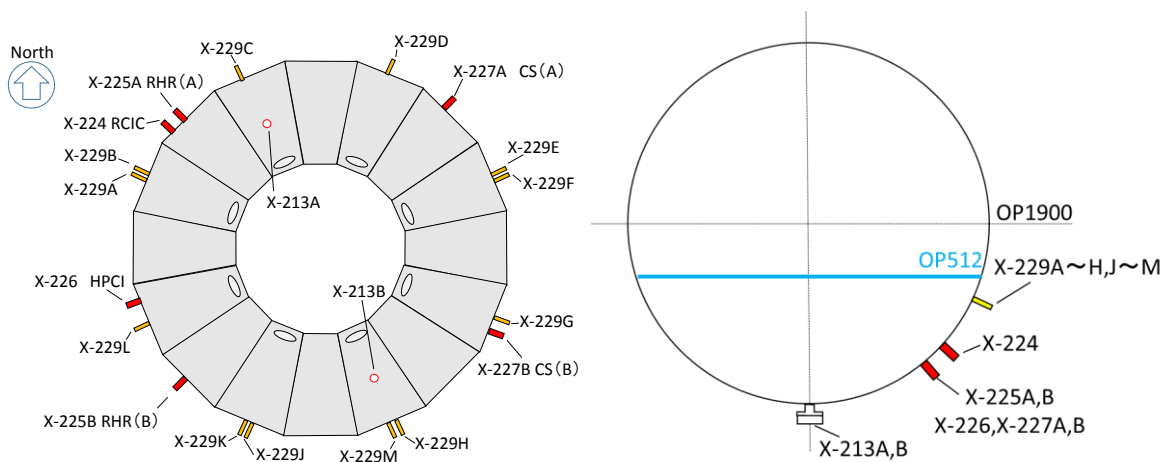

Figure 16 S/C structure of Unit-2

5. Conclusions

The mechanism of S/C temperature changes was examined from the viewpoint of the S/C water level changes. The area and location of the leak hole was also examined quantitatively based on the data having been observed. The conclusions are as follows.

- The S/C water level affected the S/C gaseous temperatures and pool water temperatures, because the state of heat inflow to the S/C changed depending on whether the S/C water level was higher or lower than the leak hole in the vacuum breaker valve.
- It was clarified that the S/C water level change was affected by the D/W pressures, the retained water levels and the amount of water injection, when calculations were made based on the observed data and assuming a leak hole in the lower part of S/C.
- The leak area which showed good consistency between the temperature changes due to water level changes and the measured temperatures was about 9cm^2 . The leak hole was located below OP512.
- Pipe lines connected to the S/C which might include the leak hole are the drain stoppers, pump suction lines of RCIC, RHR, HPCI and the core spray system, and pneumatic lines for driving the vacuum breaker valve.

6. References

[1] Situation (results) of nitrogen gas injection tests for purging hydrogen gas from S/C of Unit-2 at Fukushima Daiichi Nuclear Power Station (2nd report), TEPCO, December 15th, 2013 (in Japanese)

http://www.meti.go.jp/earthquake/nuclear/pdf/131226/131226_01n.pdf

[2] Report on Measures Based on Temperature Rise in the Bottom Section Reactor Pressure Vessel of Reactor #2 at the Fukushima Daiichi Nuclear Power Station, TEPCO, February 15th, 2012 (in English)

http://www.tepco.co.jp/en/press/corp-com/release/betu12_e/images/120216e5.pdf