

2016年1月29日
東京電力株式会社

建屋内の空間線量率について

データ採取期間

- ・ 6号機 : 2015年11月1日～2015年11月30日

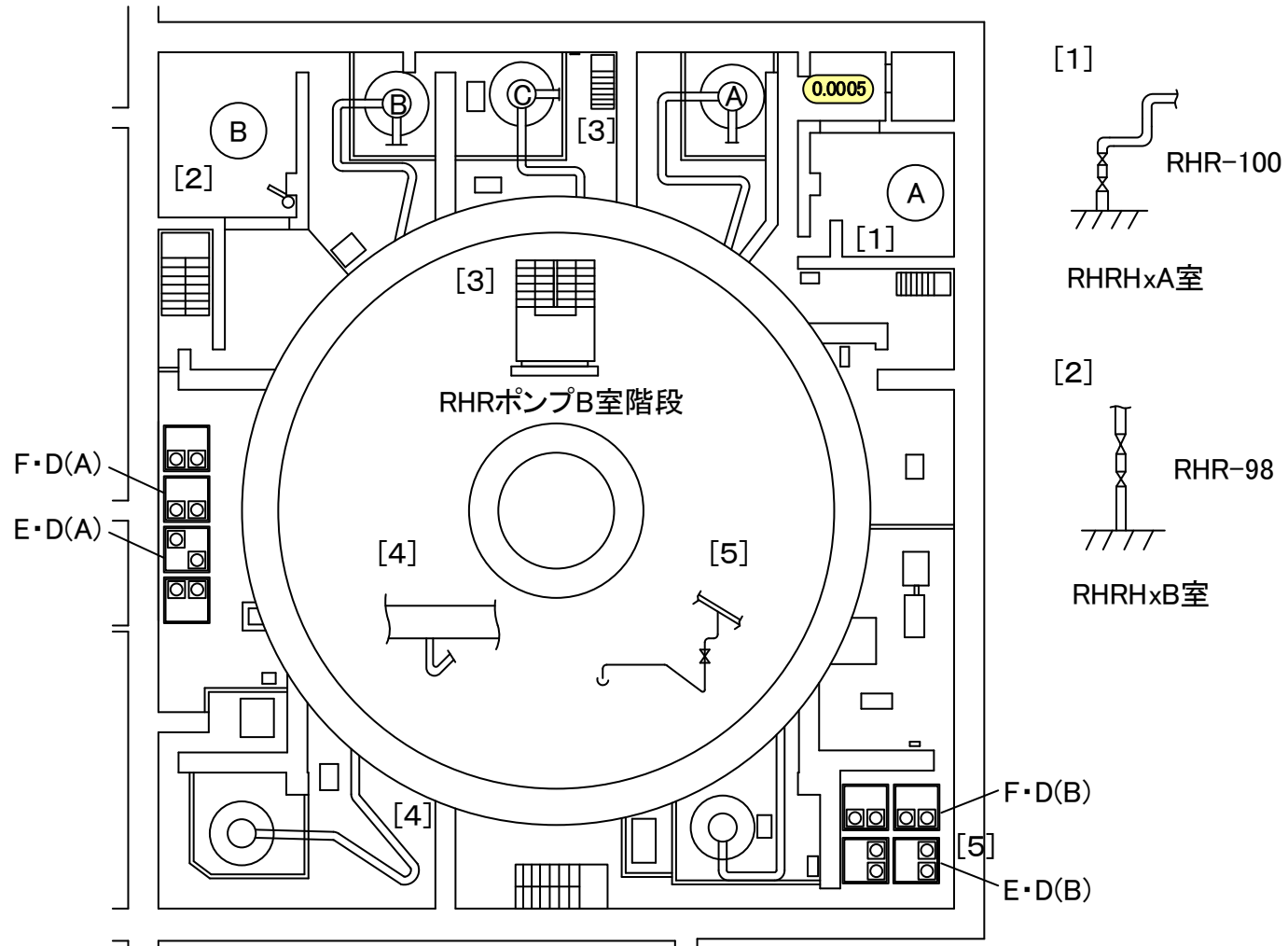

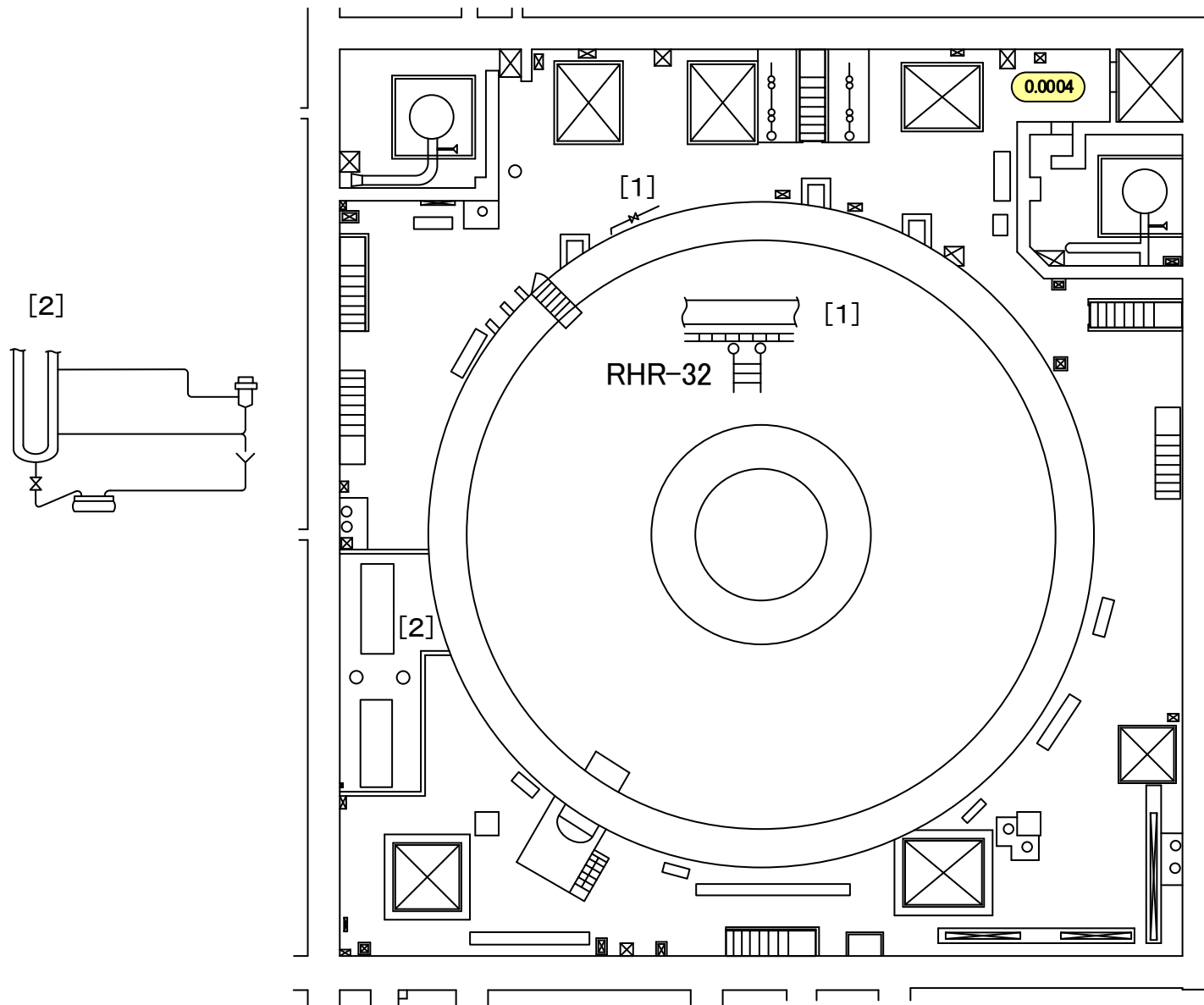

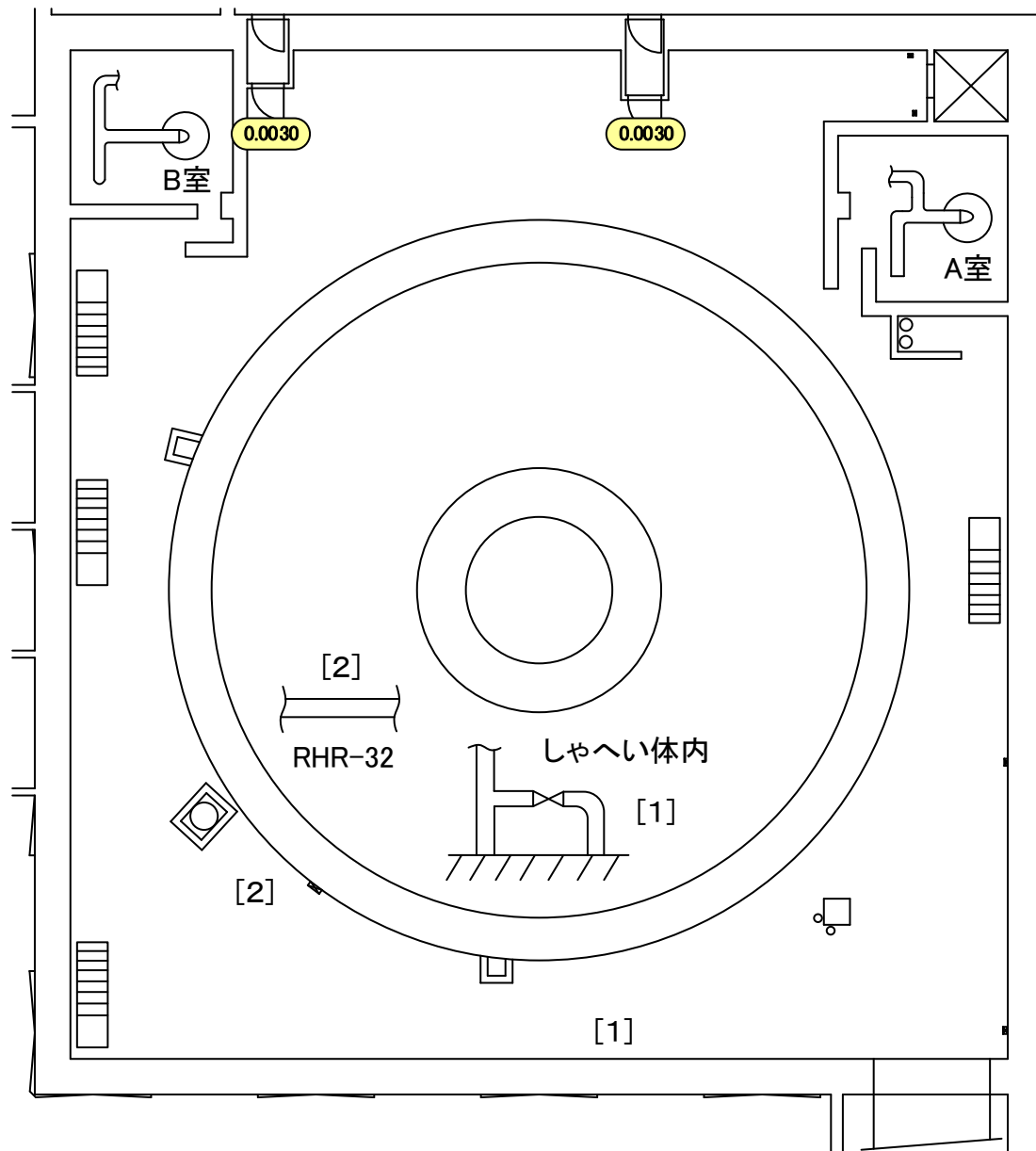

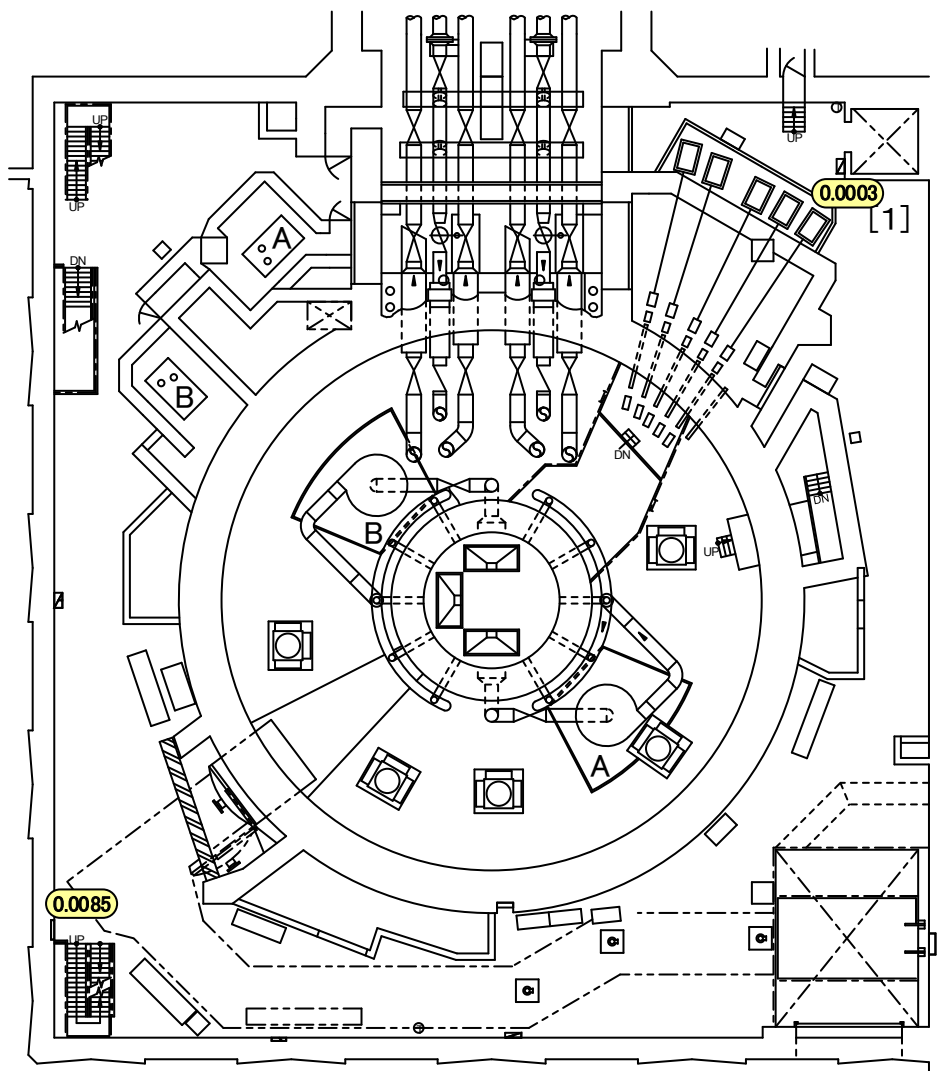

[1]

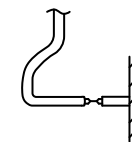

FPC-49

[1]
サンプリング
ラック

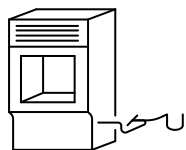

[2]
グレーチング
上

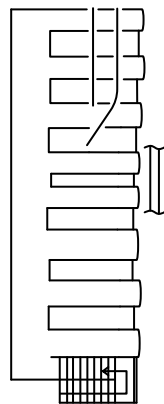

[3]
CRD吐出
フィルター

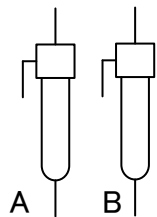

[4]
グレーチング
上

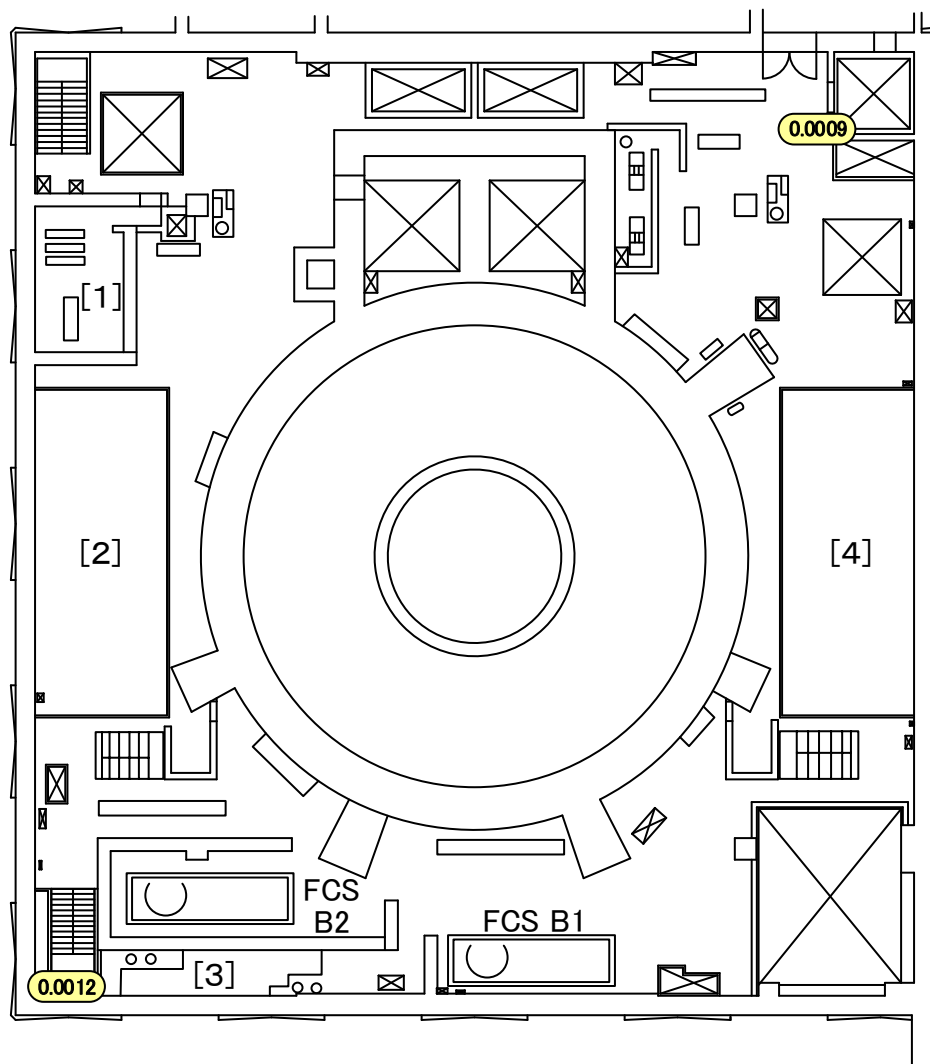
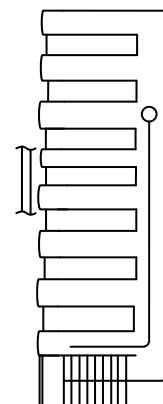

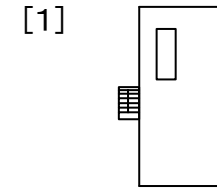
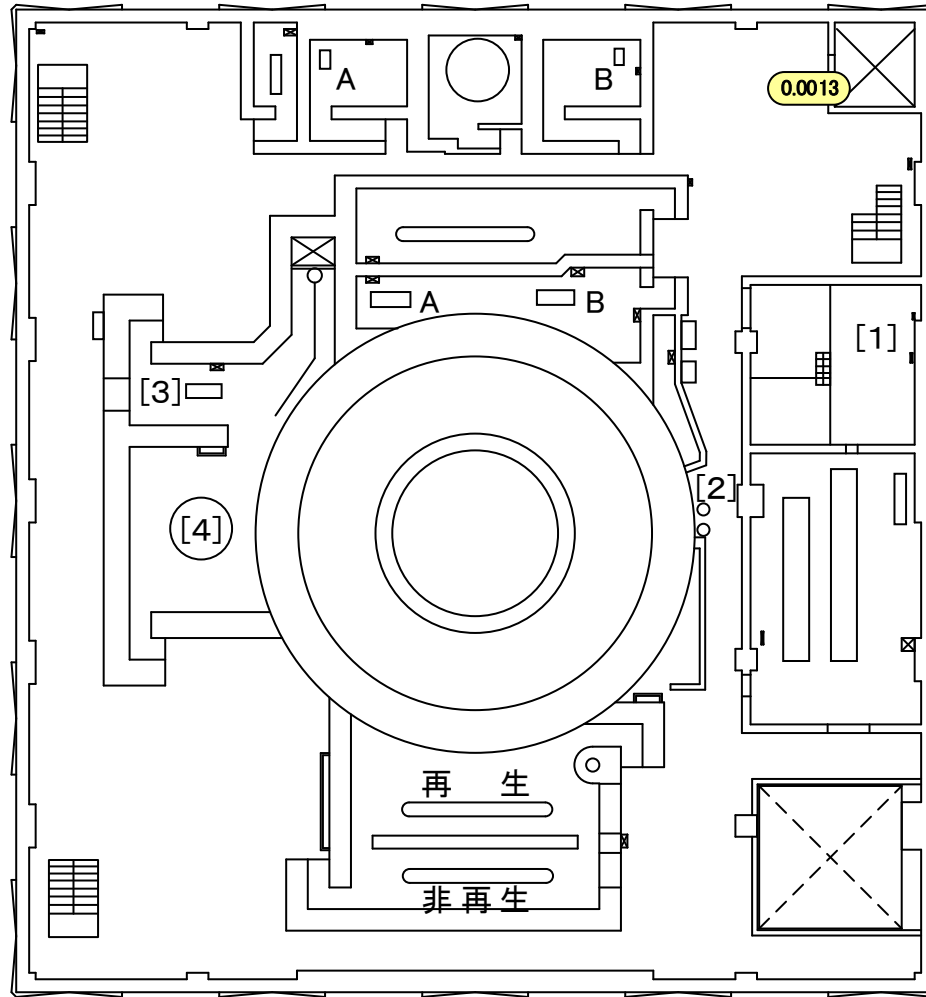

[1]
CRD半自動分解装置
操作エリア

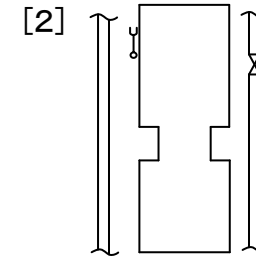

[2]
南側通路
グレーチング上



[3]
CUW逆洗水移送ポンプ

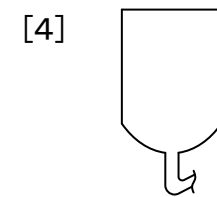

[4]
CUW逆洗水受タンク

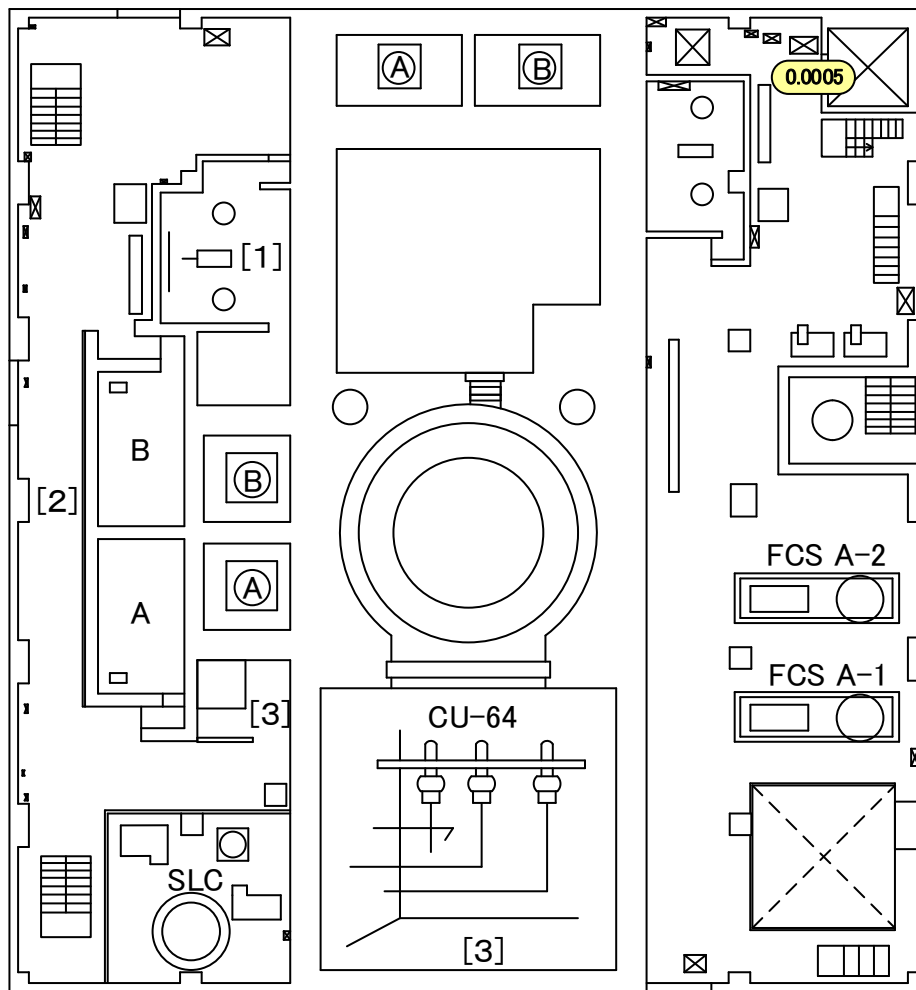
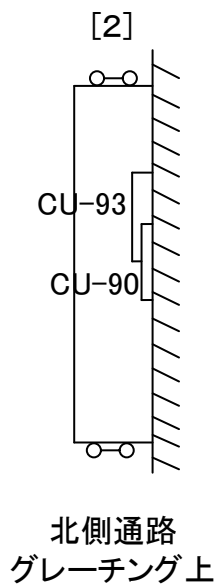
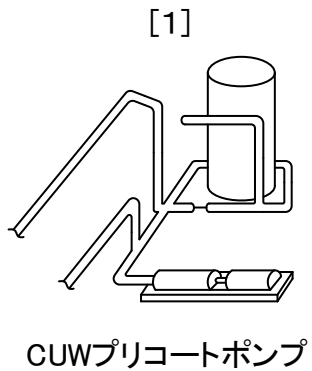

福島第一 原子力発電所

図面名称:

6号機 原子炉建屋 6階

[単位: mSv/h]

