

2016年6月30日
東京電力ホールディングス株式会社

建屋内の空間線量率について

データ採取期間

- ・ 5号機 : 2016年4月1日～2016年4月30日

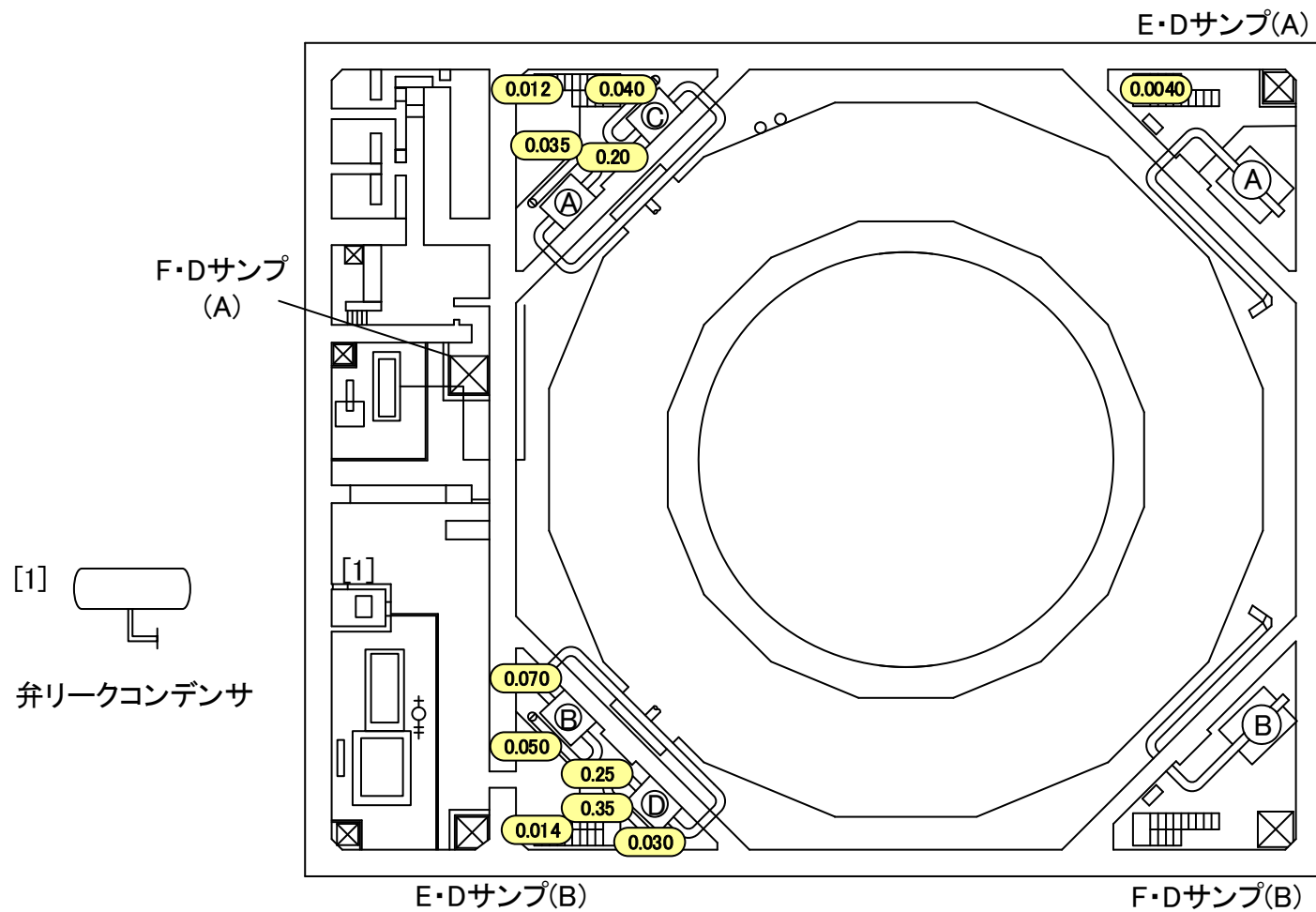

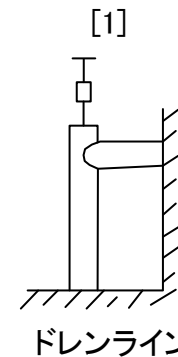
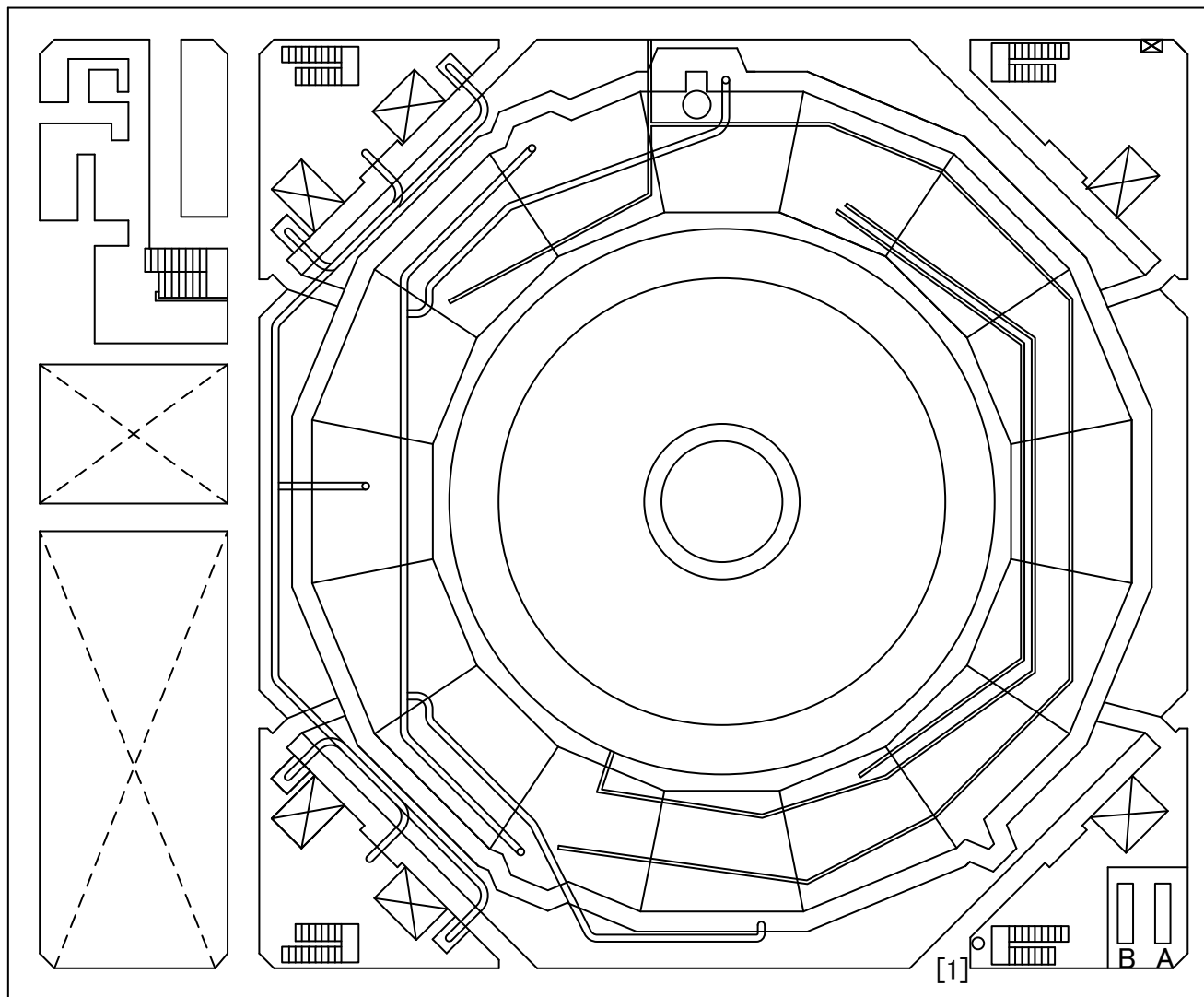

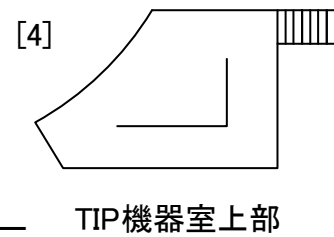
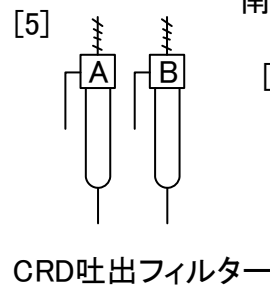
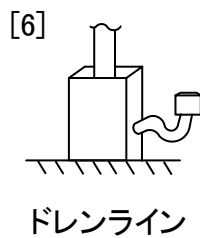
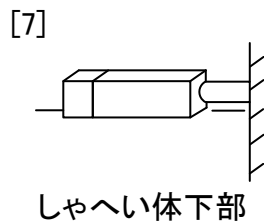
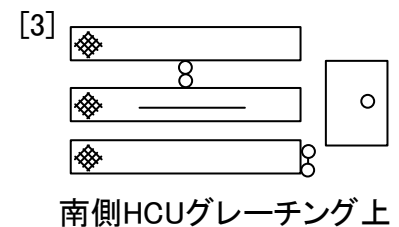
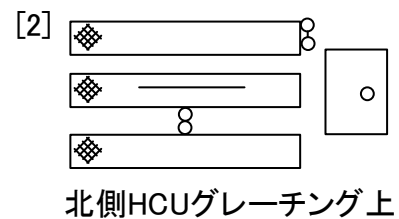
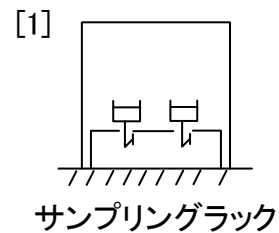
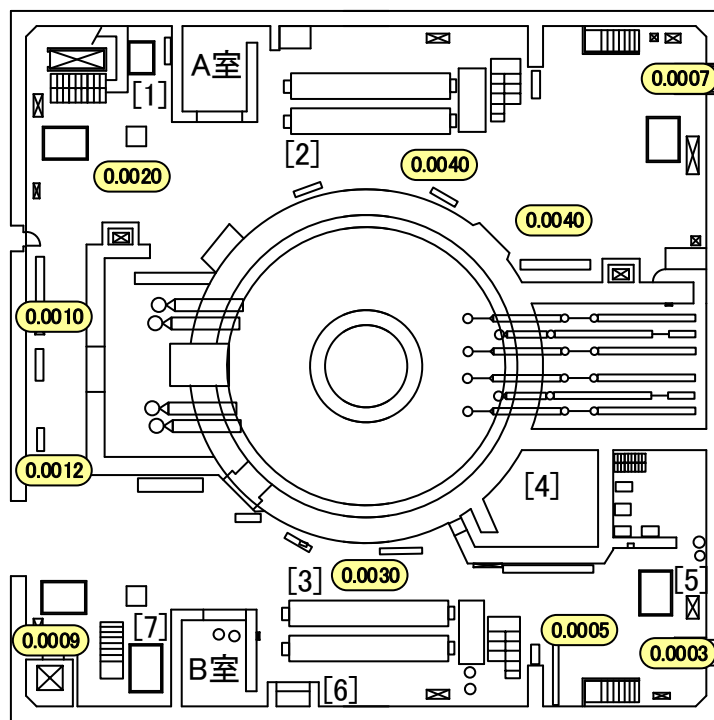

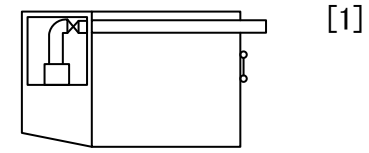
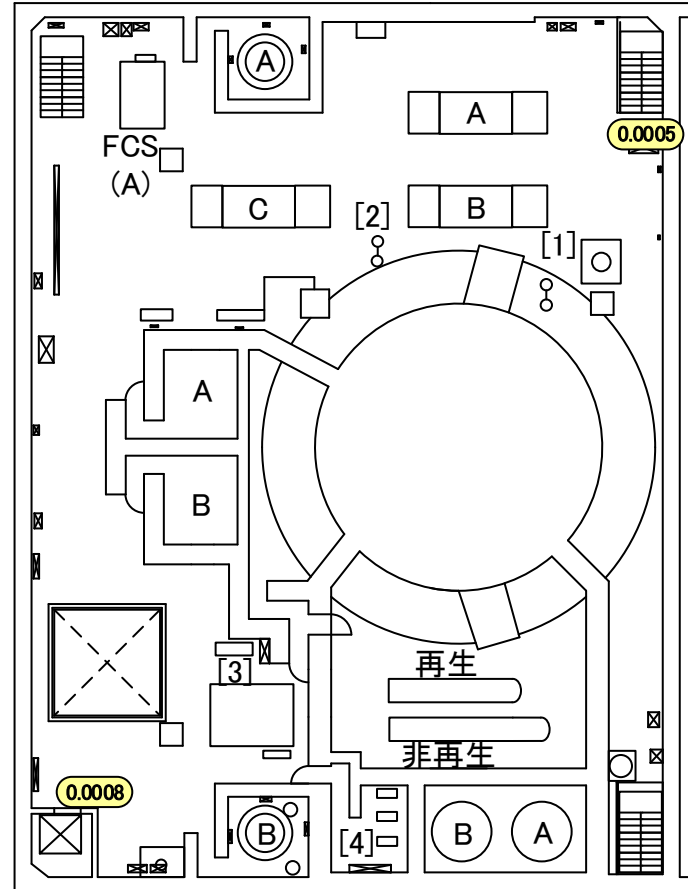

北東側グレーチング上

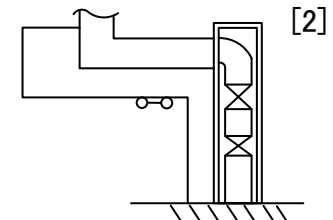

北側グレーチング上

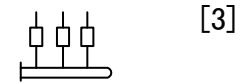

計装ラック下部

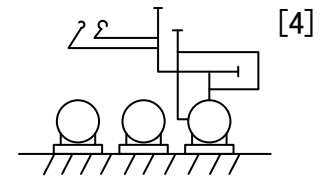

スラッジ放出混合ポンプ

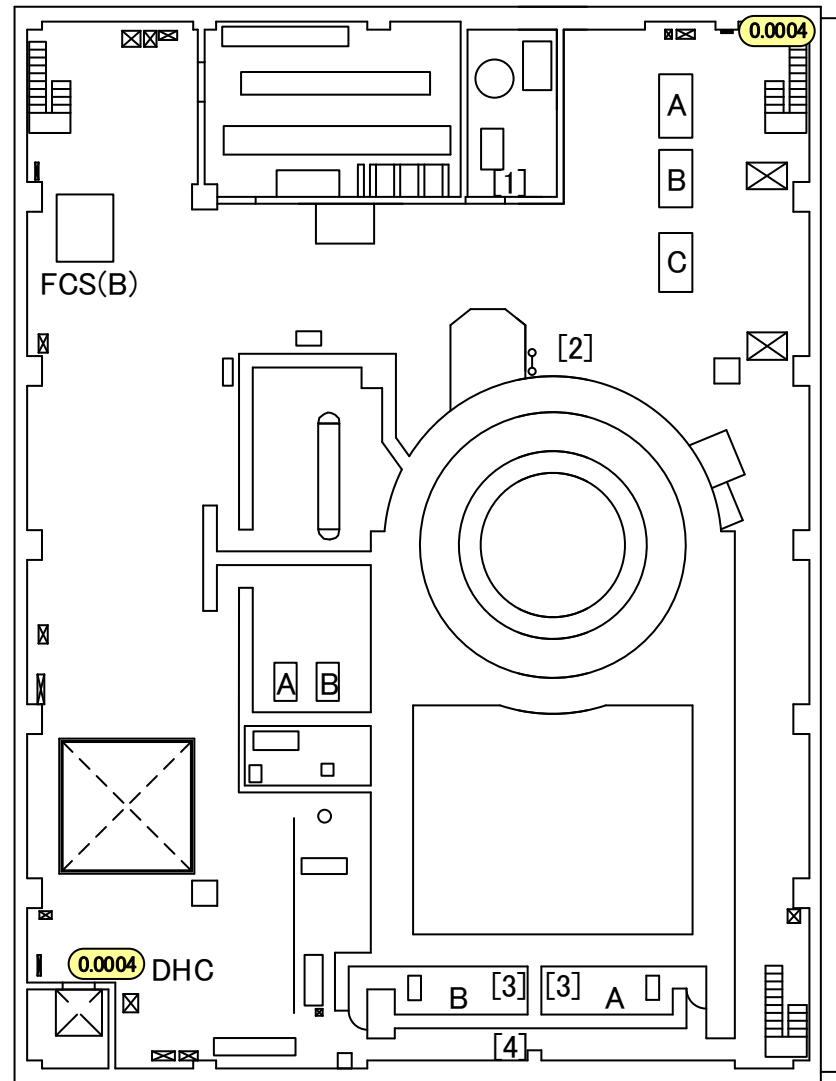
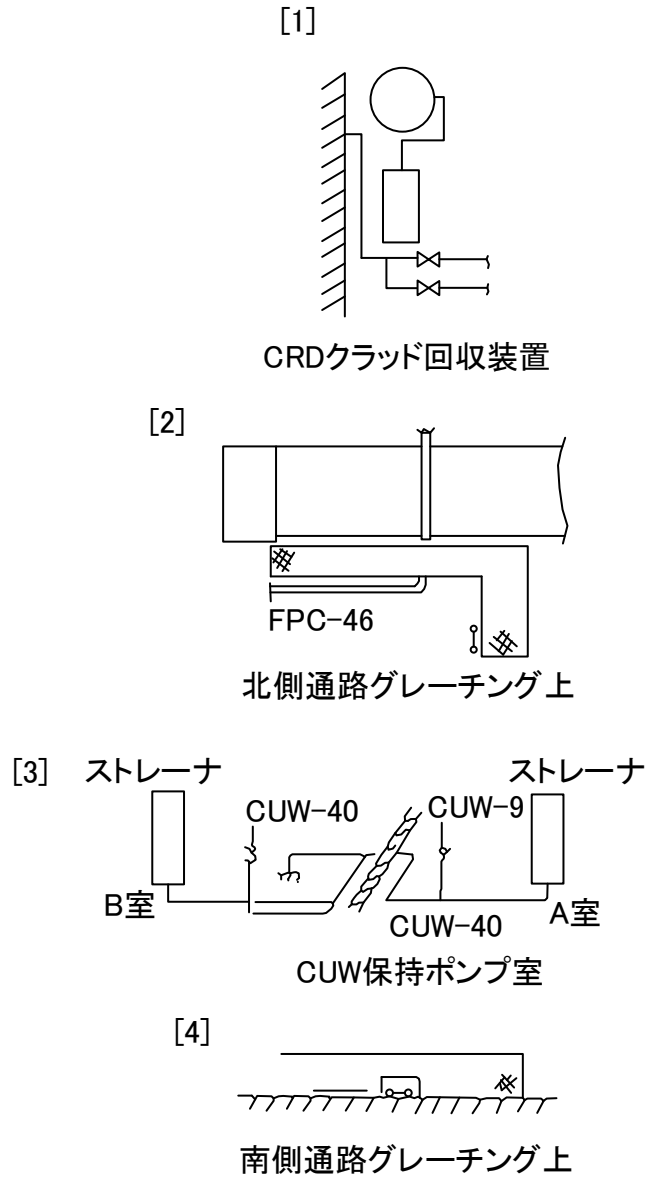

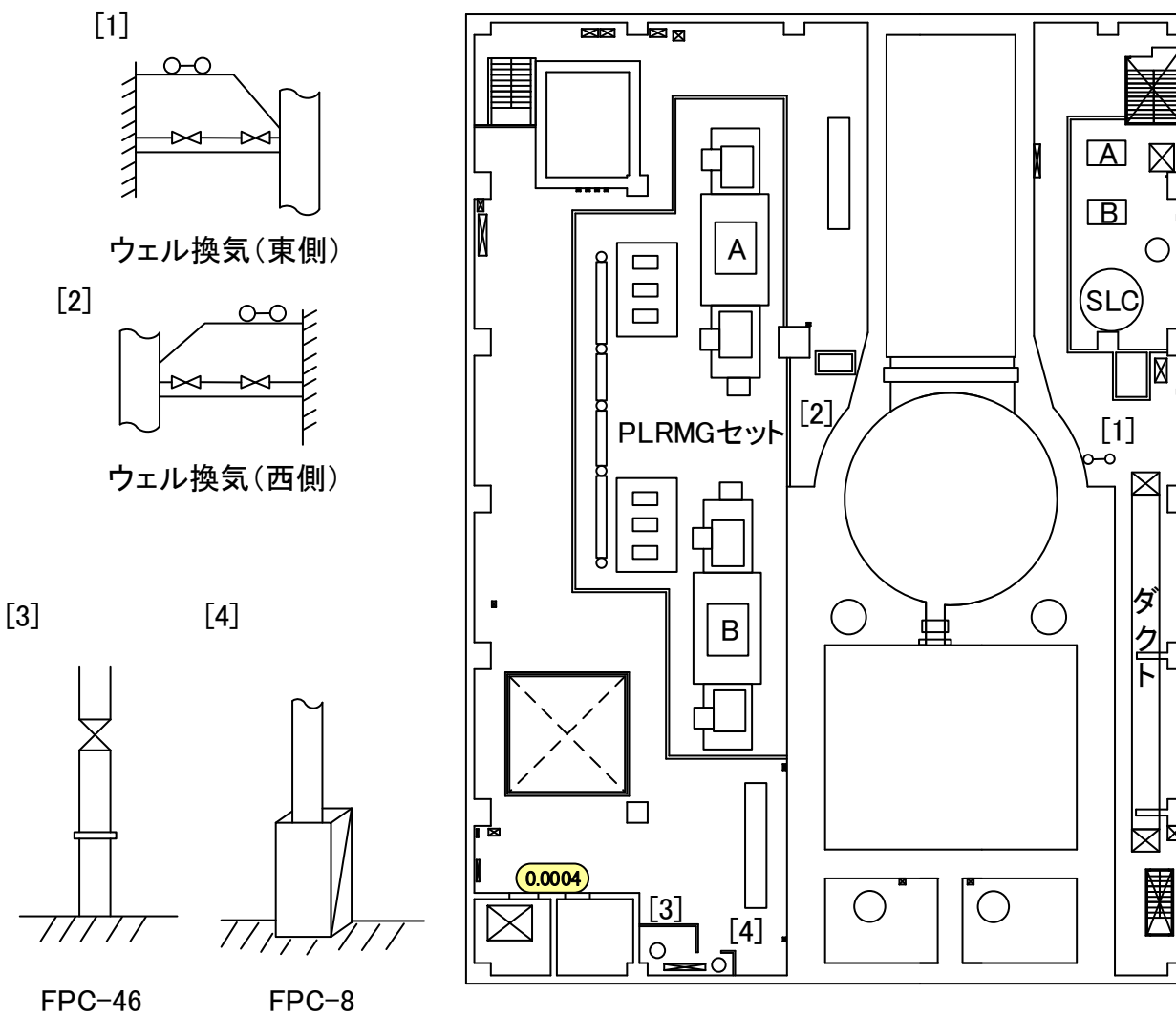

福島第一 原子力発電所

図面名称:

5号機 原子炉建屋 5階

[単位: mSv/h]

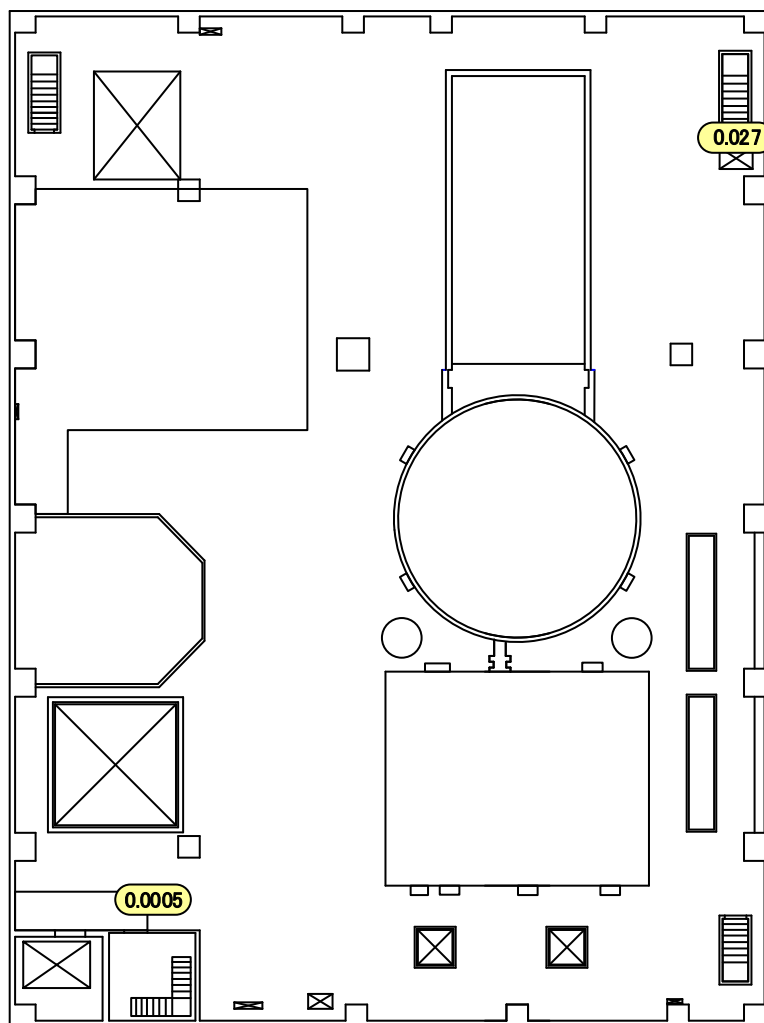

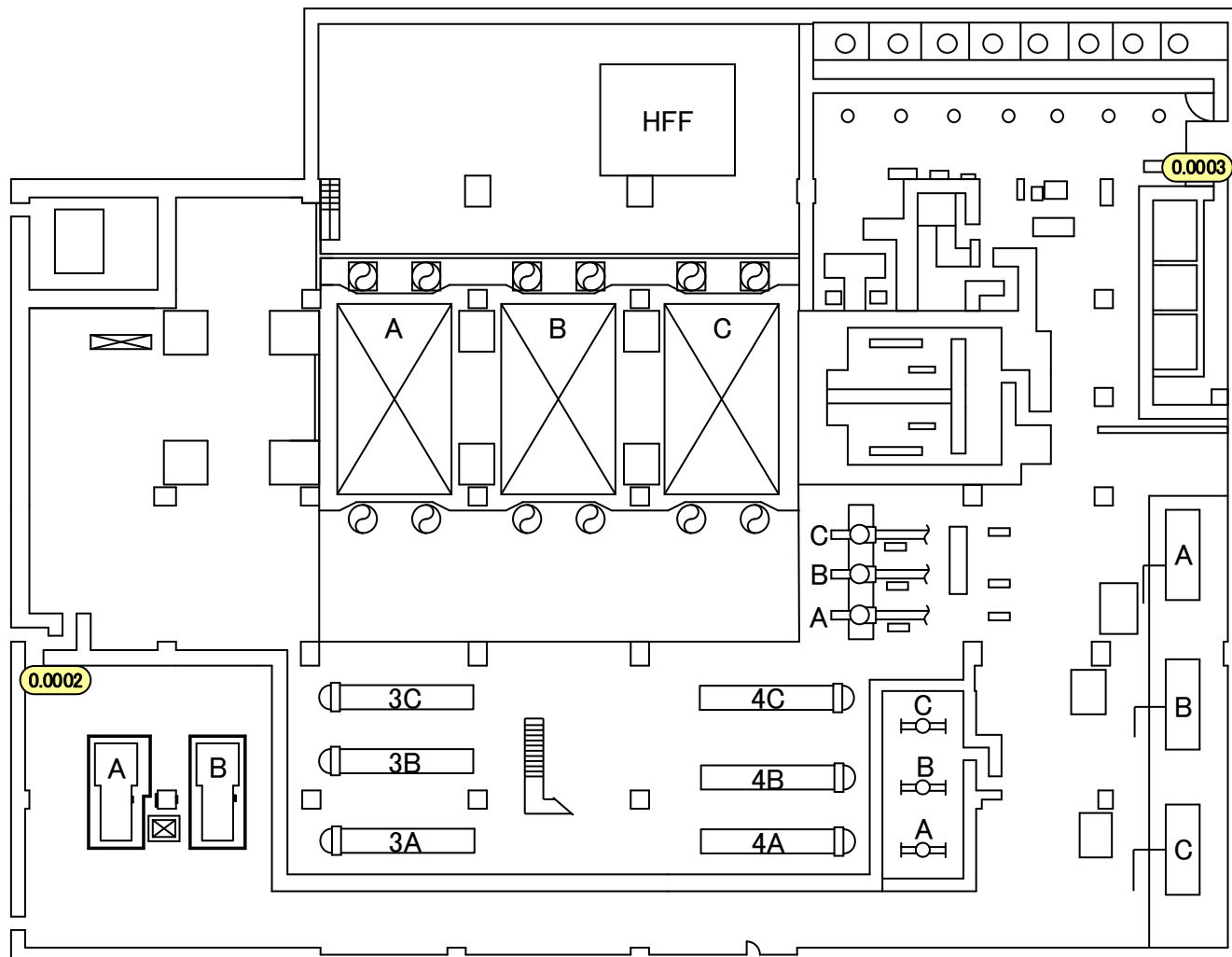

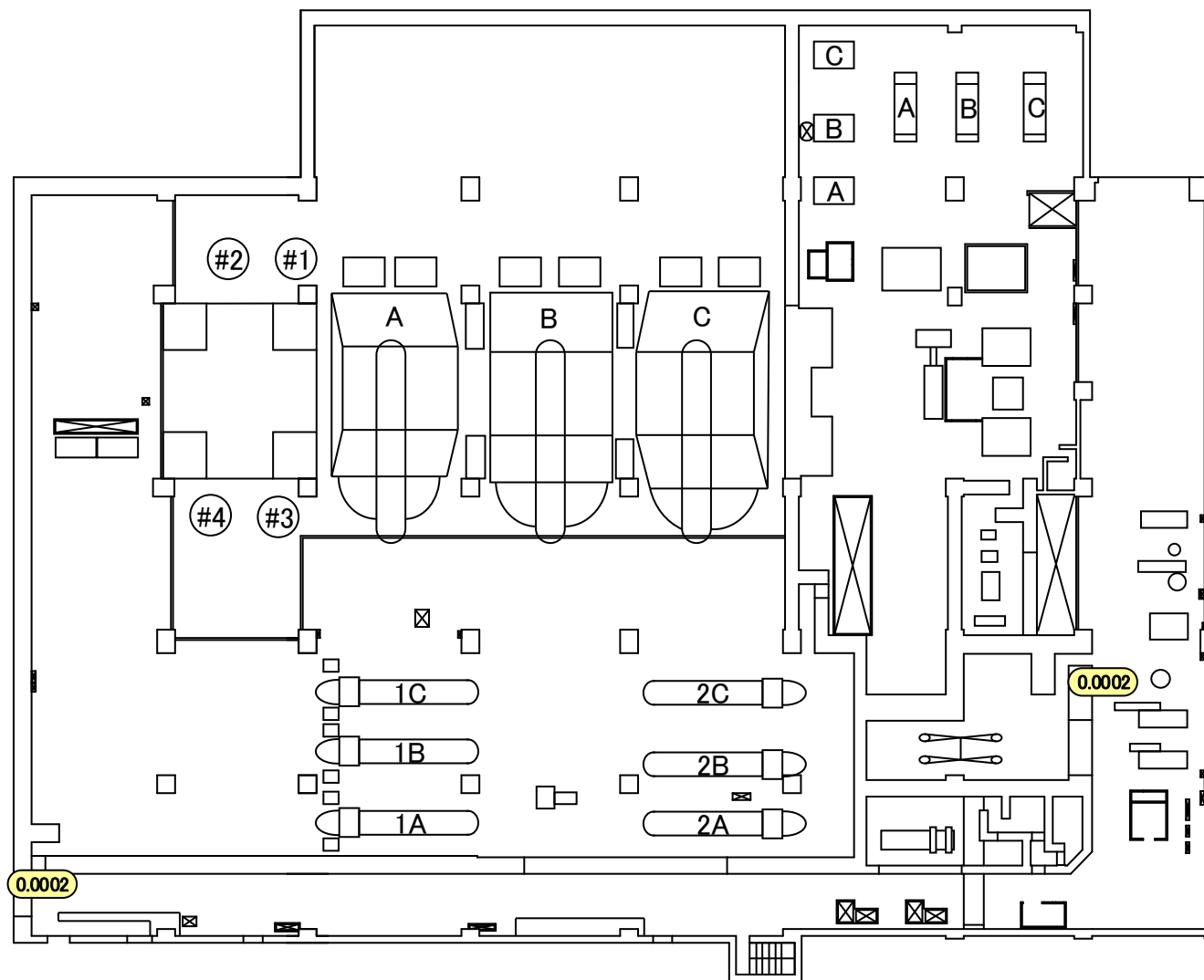

[1]
AS-23

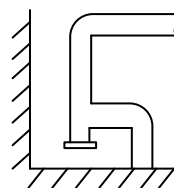

[2]
エバポレータ

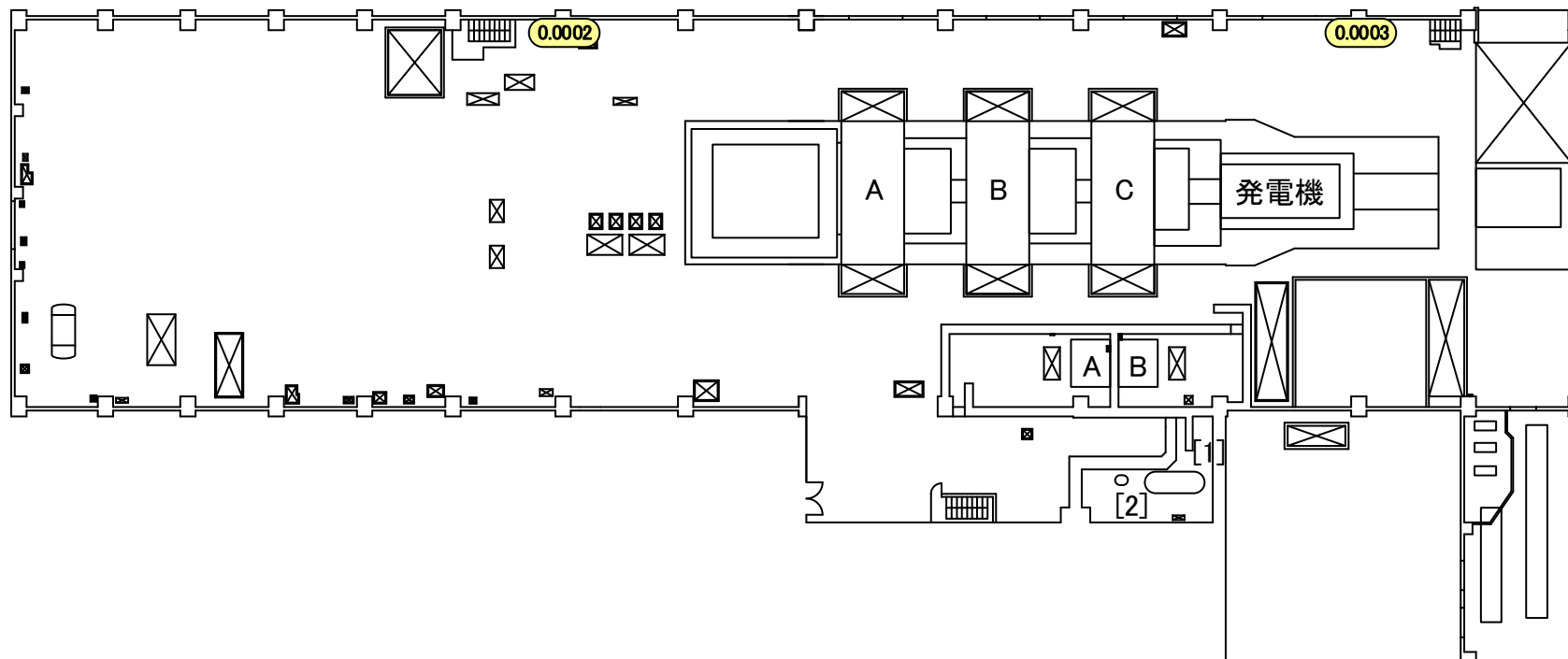
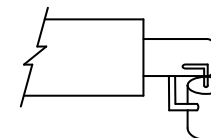

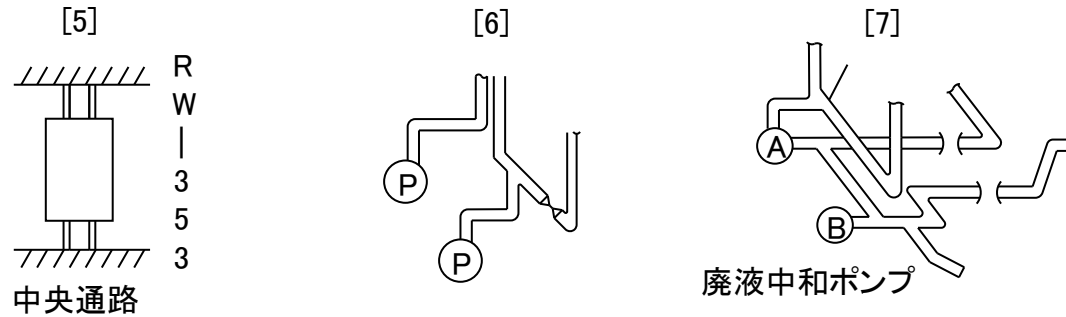
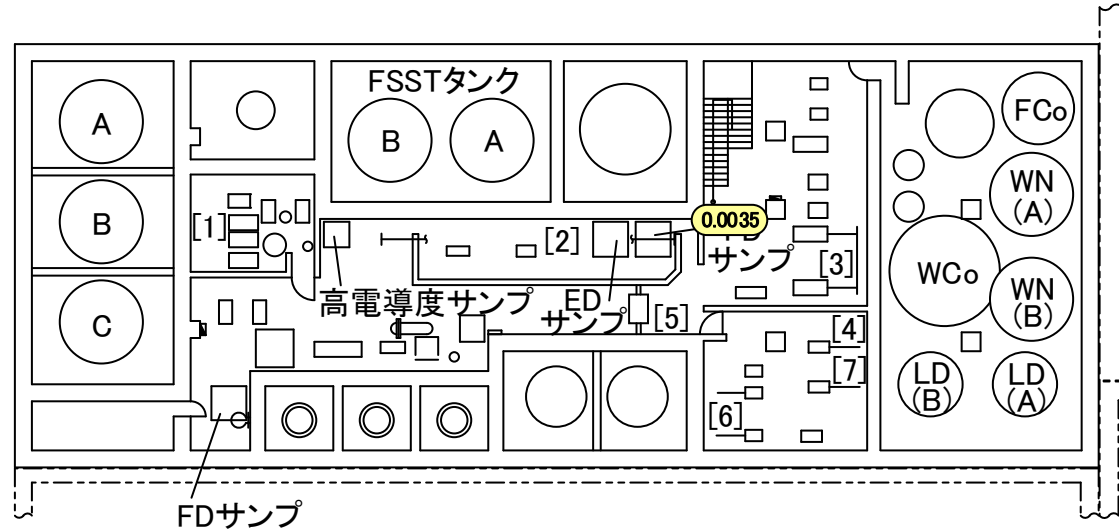
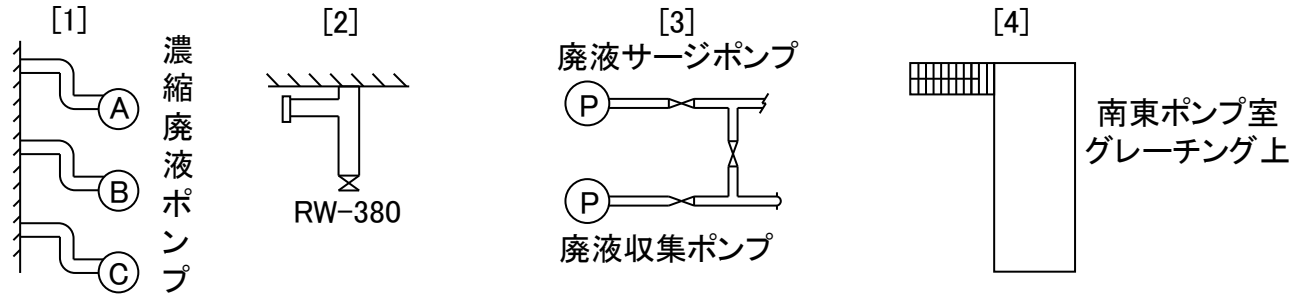

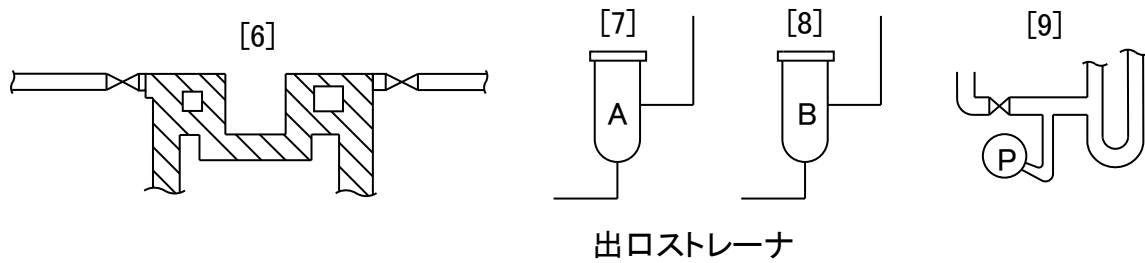
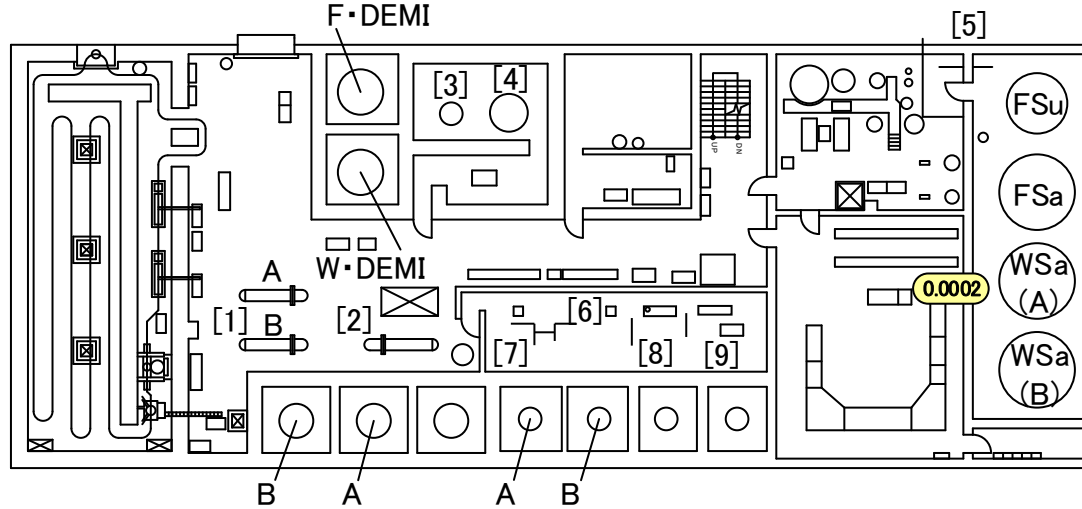
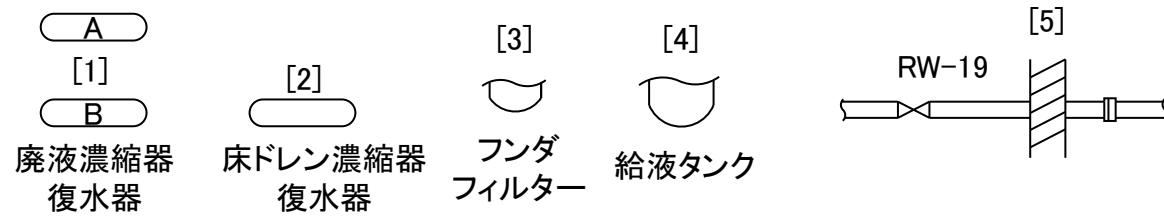

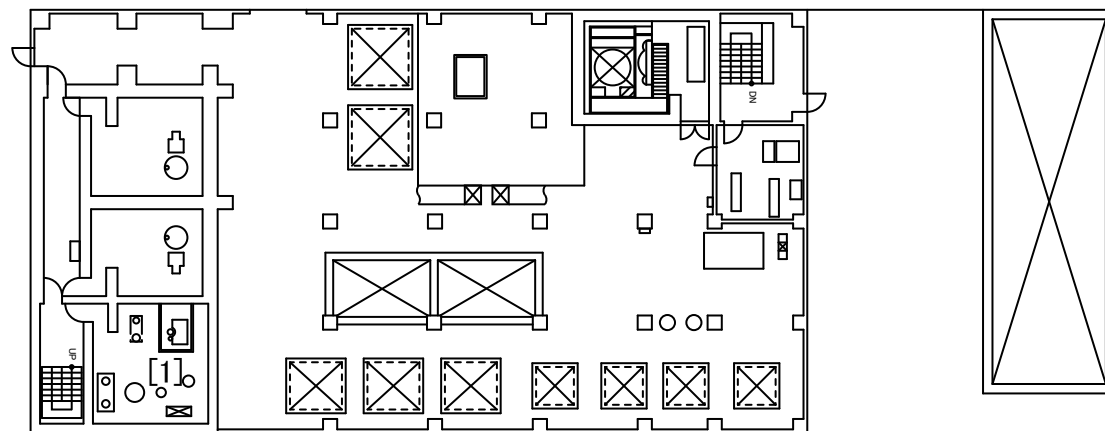

[1]



濃縮廃液計量タンク

福島第一 原子力発電所

図面名称:

5号機 廃棄物処理建屋 3階

[単位: mSv/h]

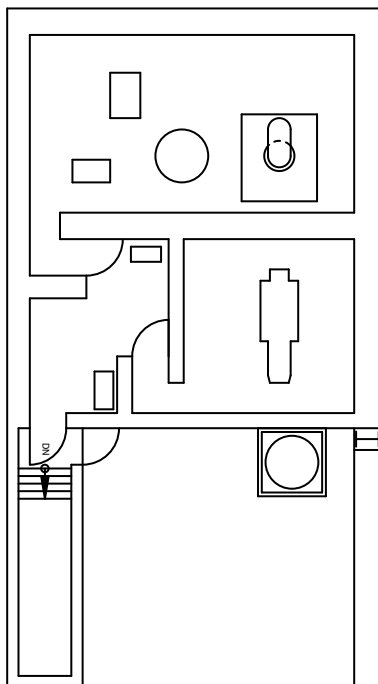

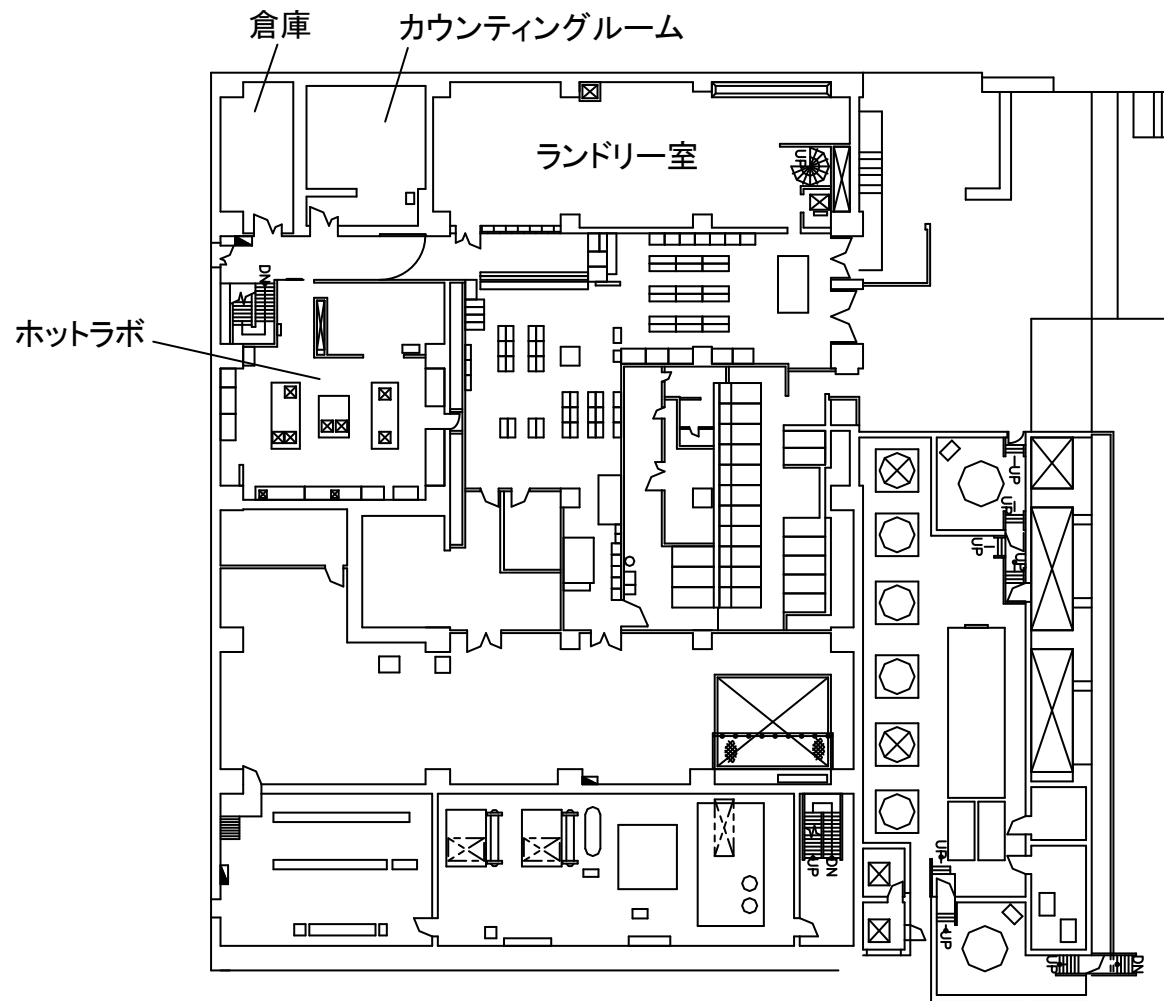

福島第一 原子力発電所

図面名称:

5・6号機 サービス建屋 2階

[単位: mSv/h]

