

2022年8月31日  
東京電力ホールディングス株式会社  
福島第一廃炉推進カンパニー

# 建屋内の空間線量率について

データ採取期間

- ・ 6号機 : 2021年4月1日～2022年3月31日

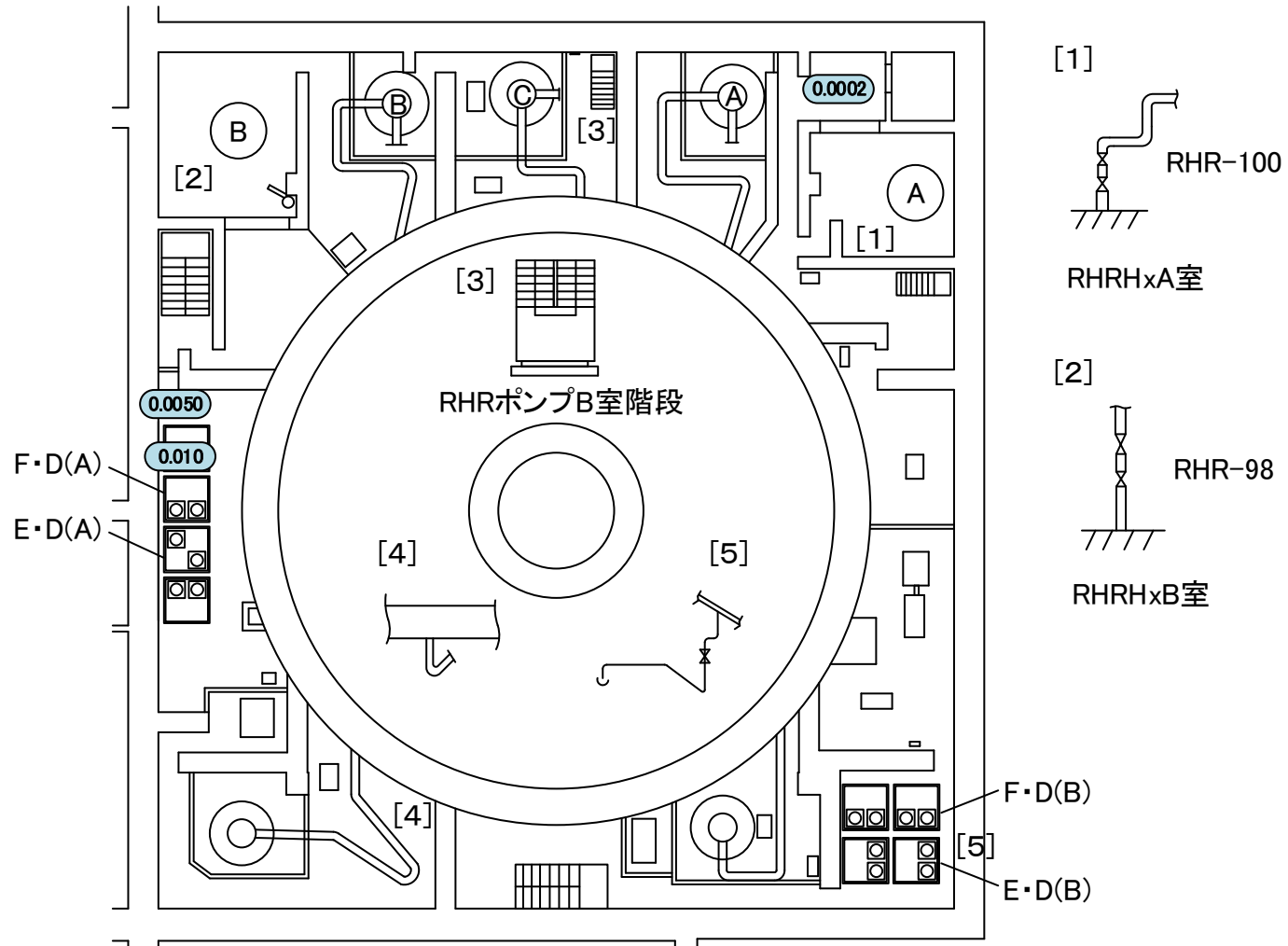

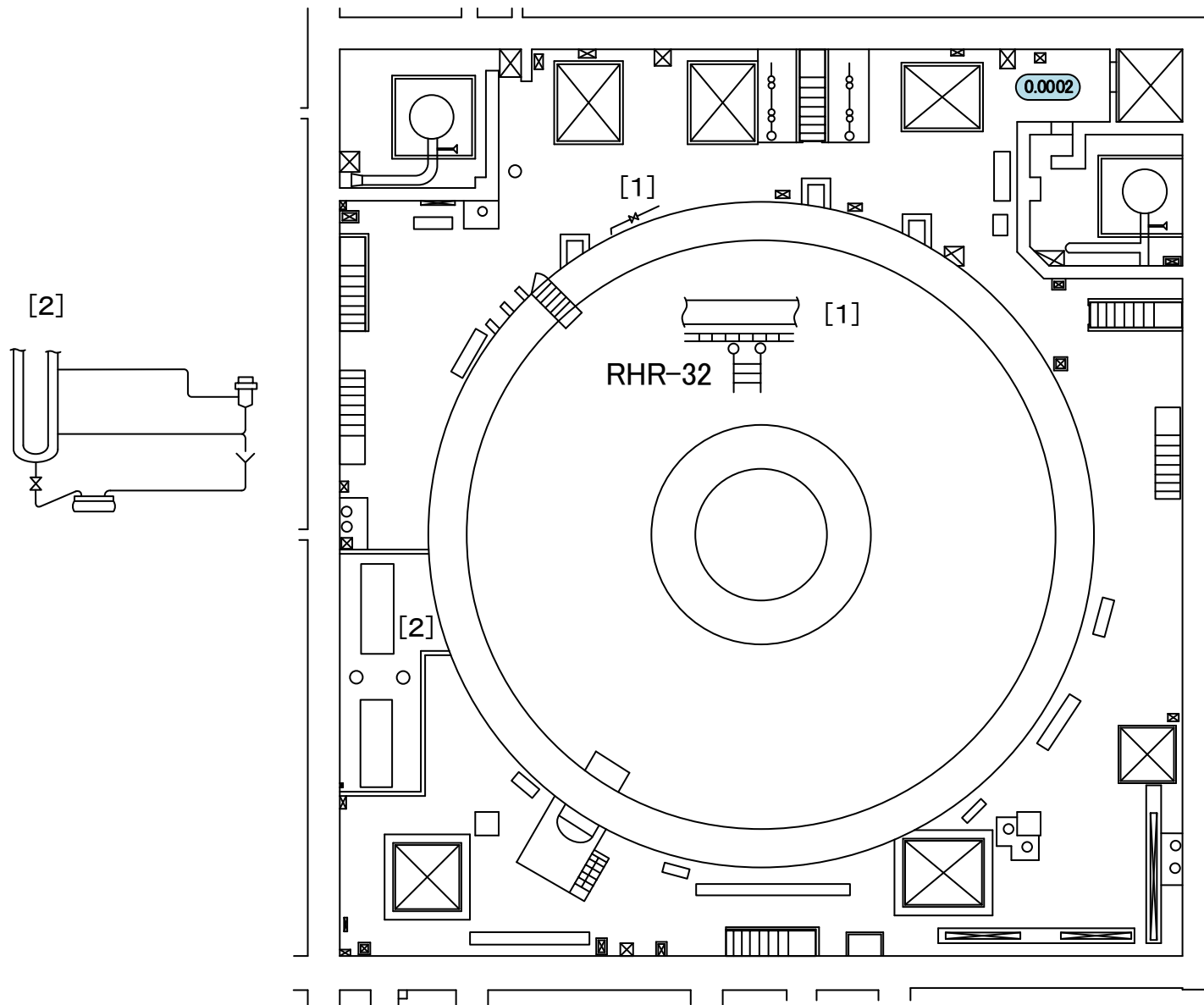

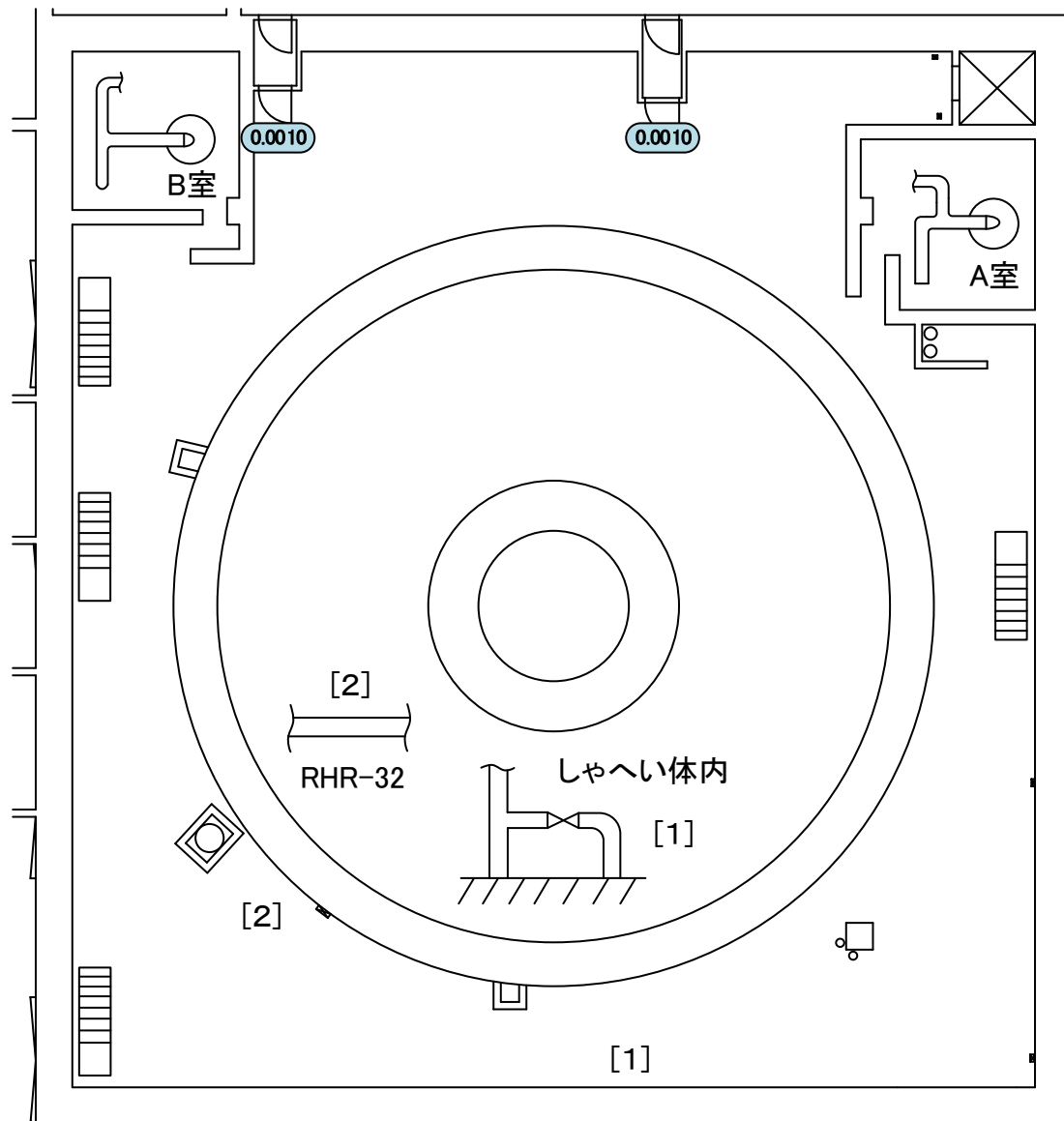

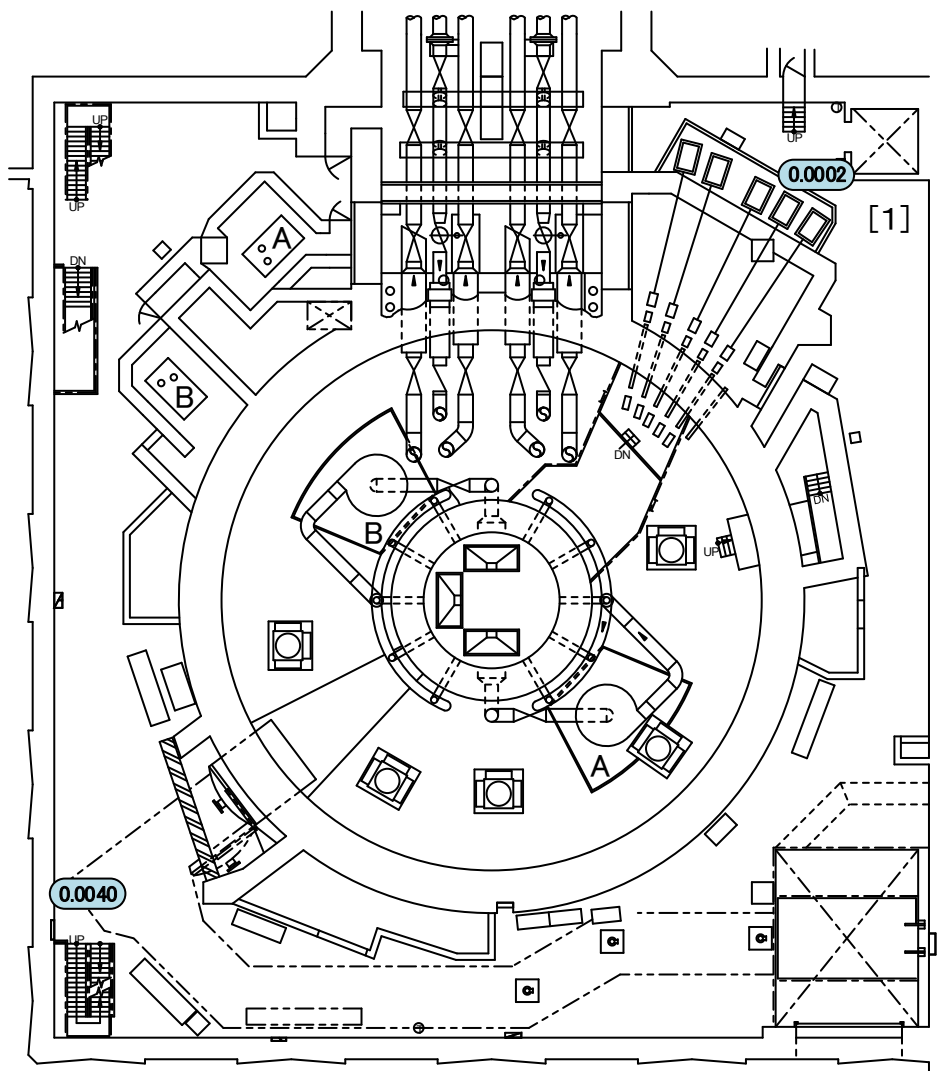

[1]

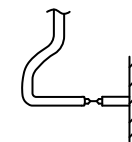

FPC-49

[1]  
サンプリング  
ラック

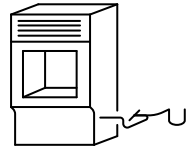

[2]  
グレーチング  
上

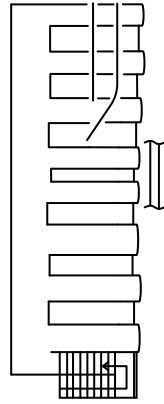

[3]  
CRD吐出  
フィルター

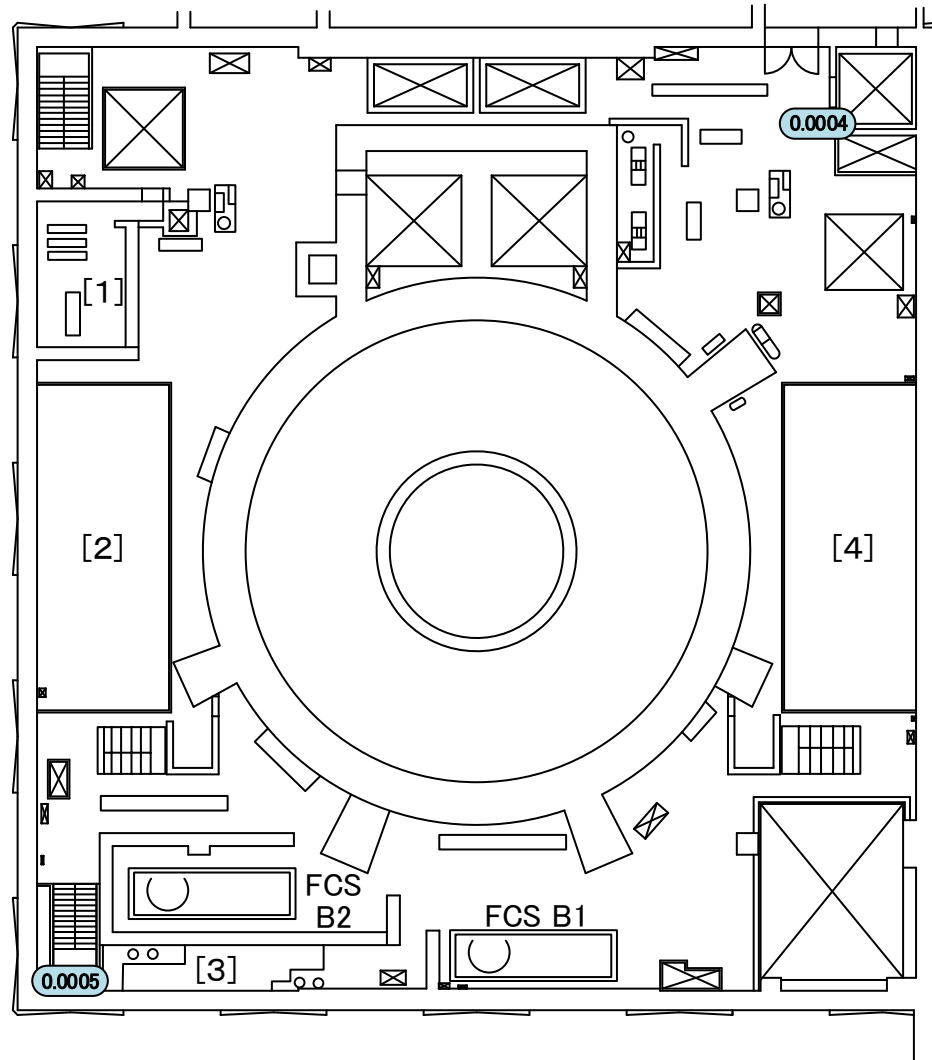
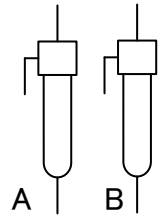

[4]  
グレーチング  
上

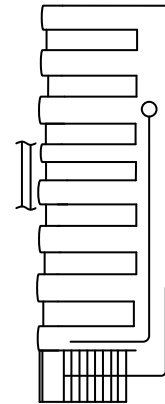

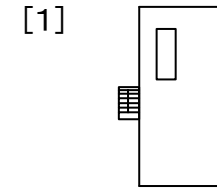
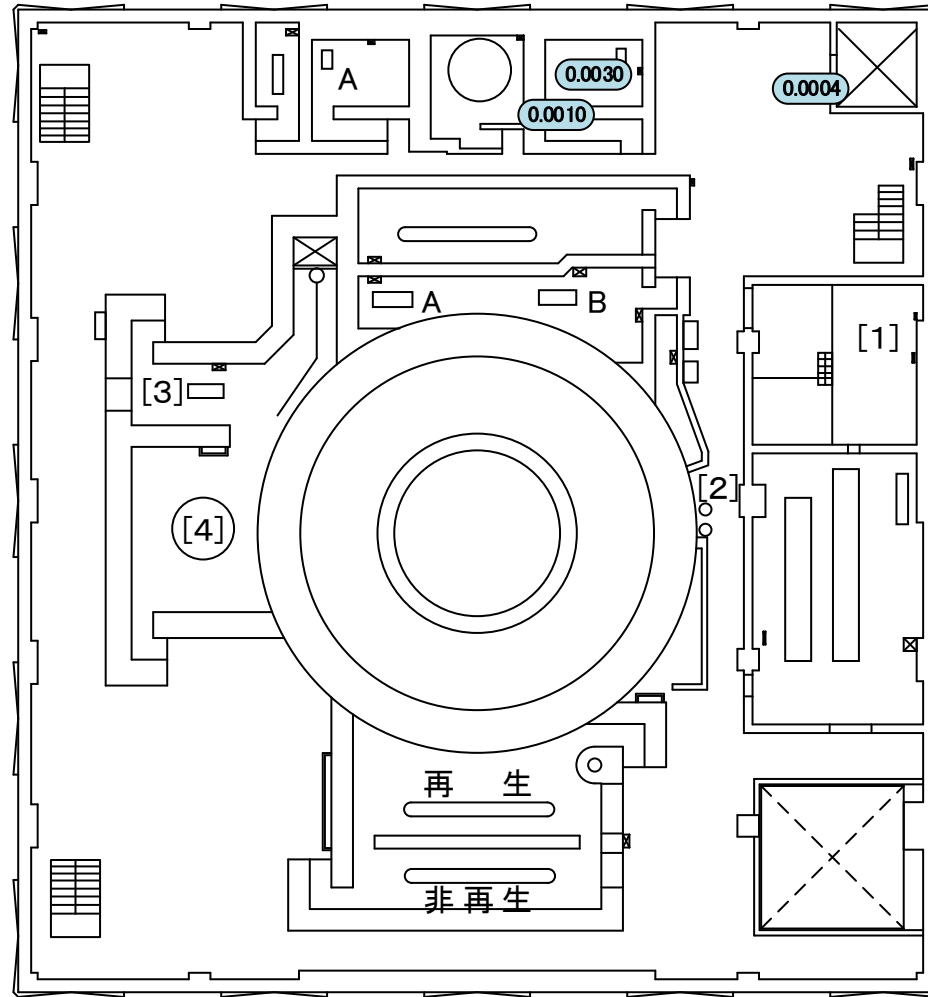

[1]  
CRD半自動分解装置  
操作エリア

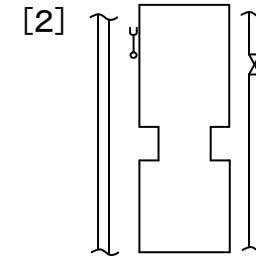

[2]  
南側通路  
グレーチング上



[3]  
CUW逆洗水移送ポンプ

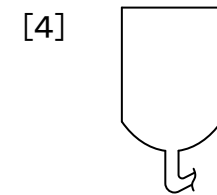

[4]  
CUW逆洗水受タンク

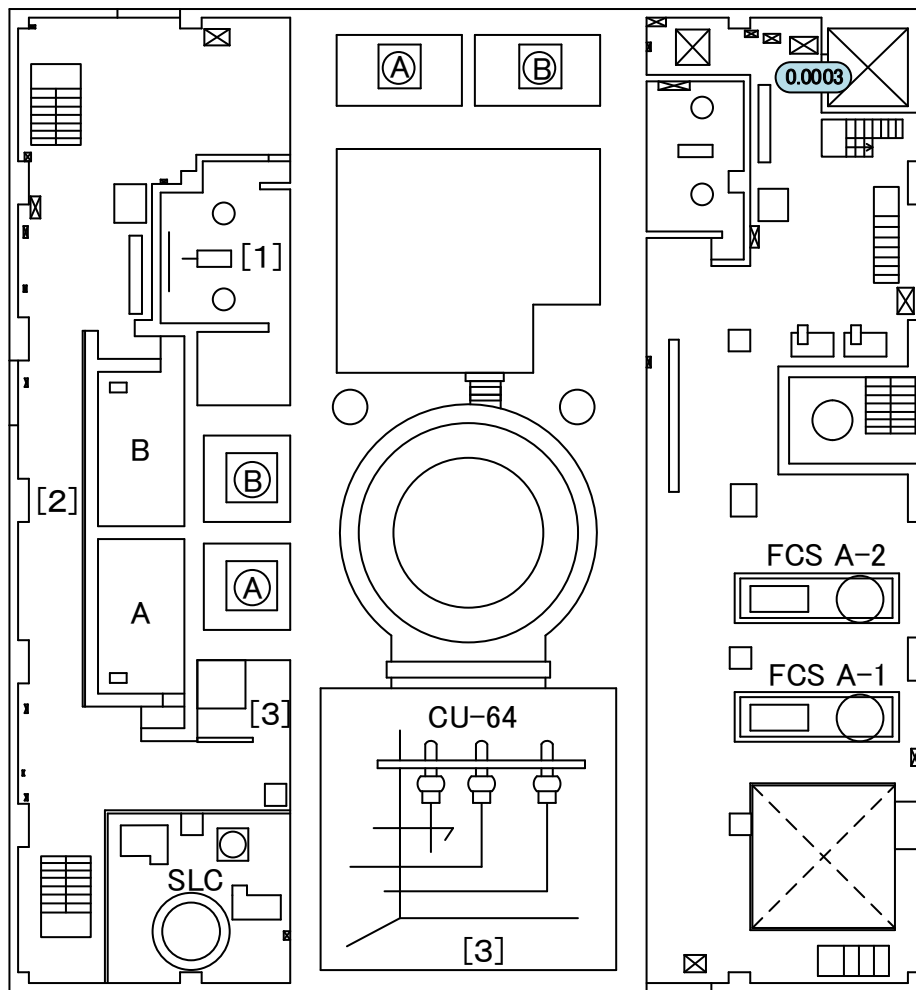
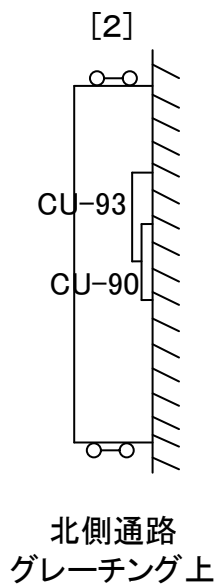
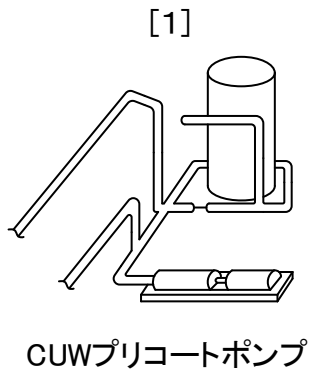



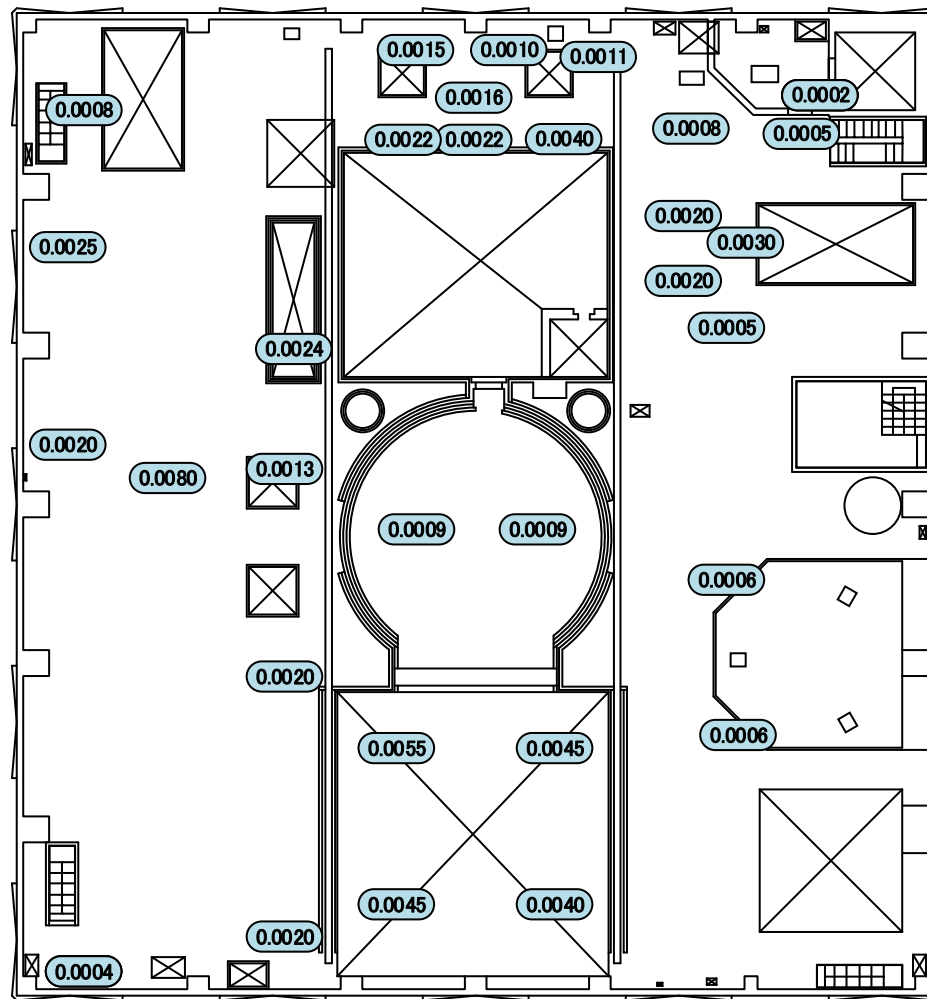

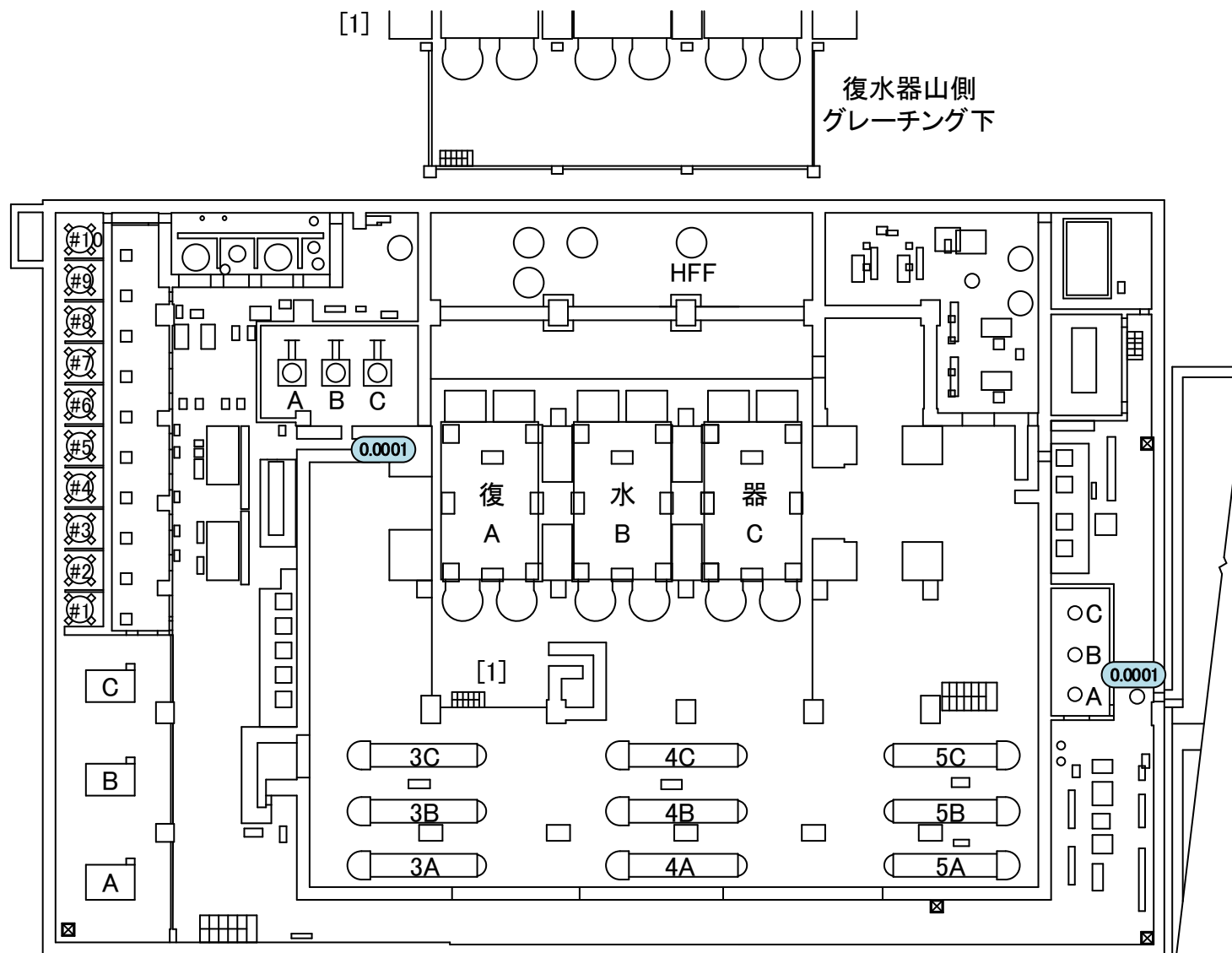

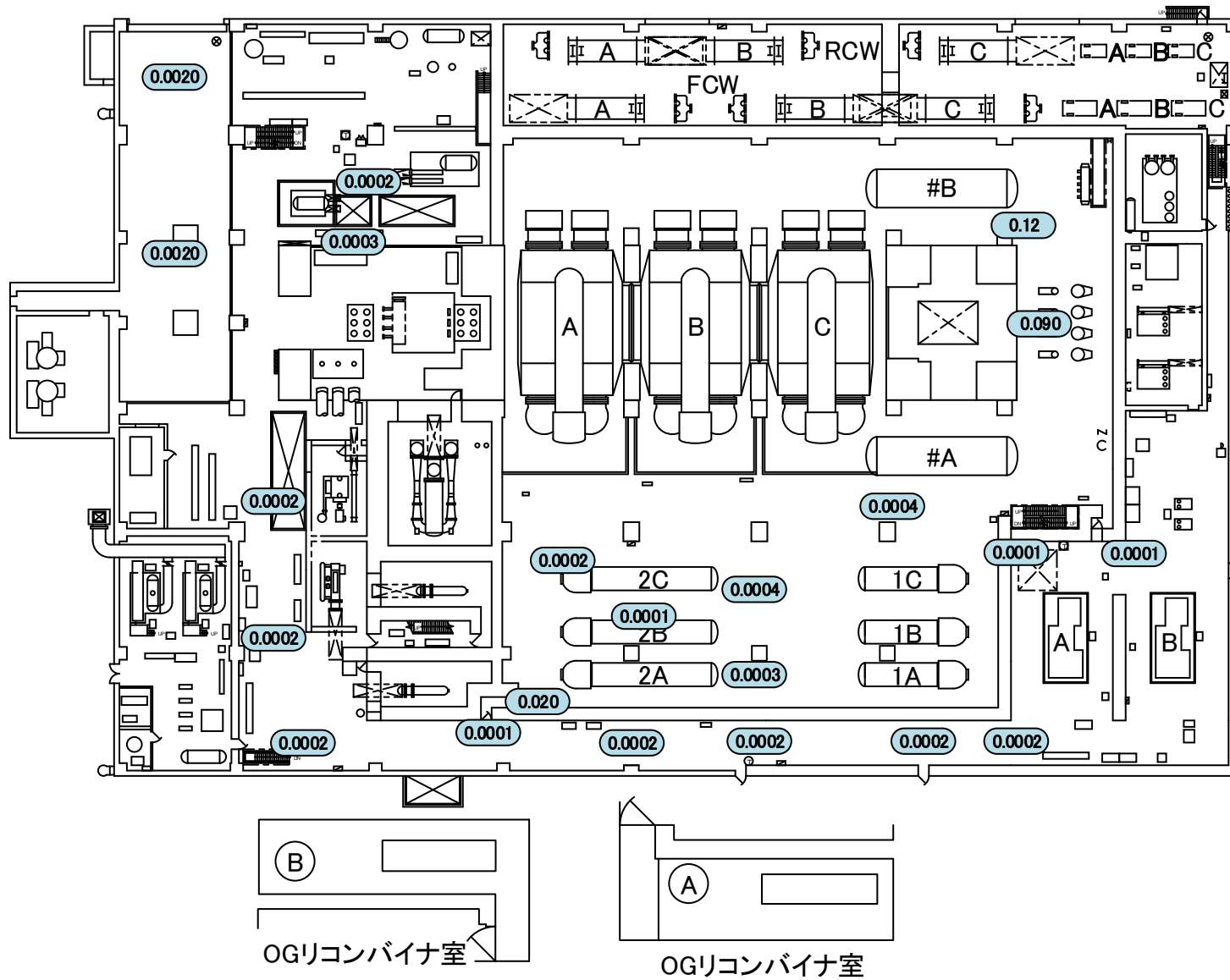

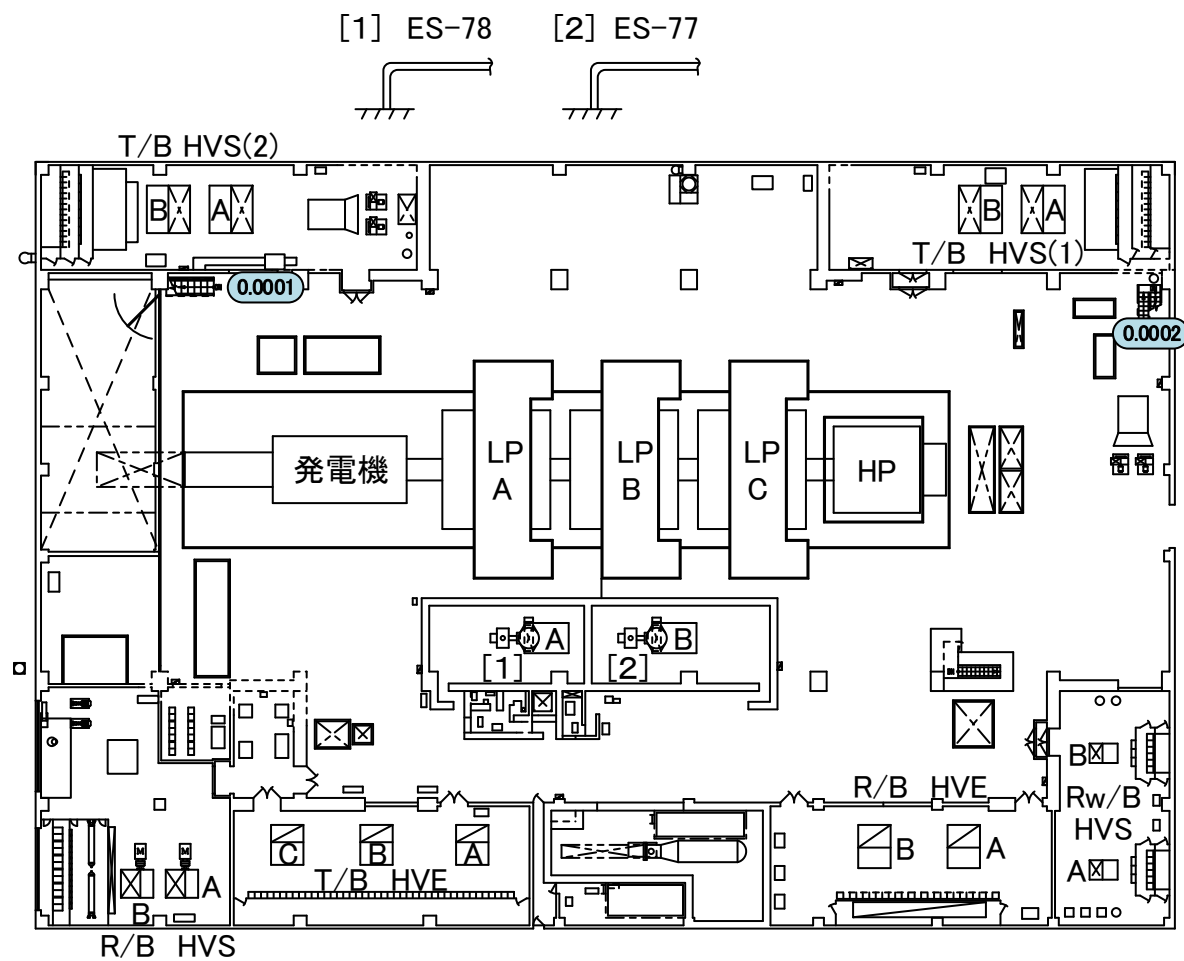

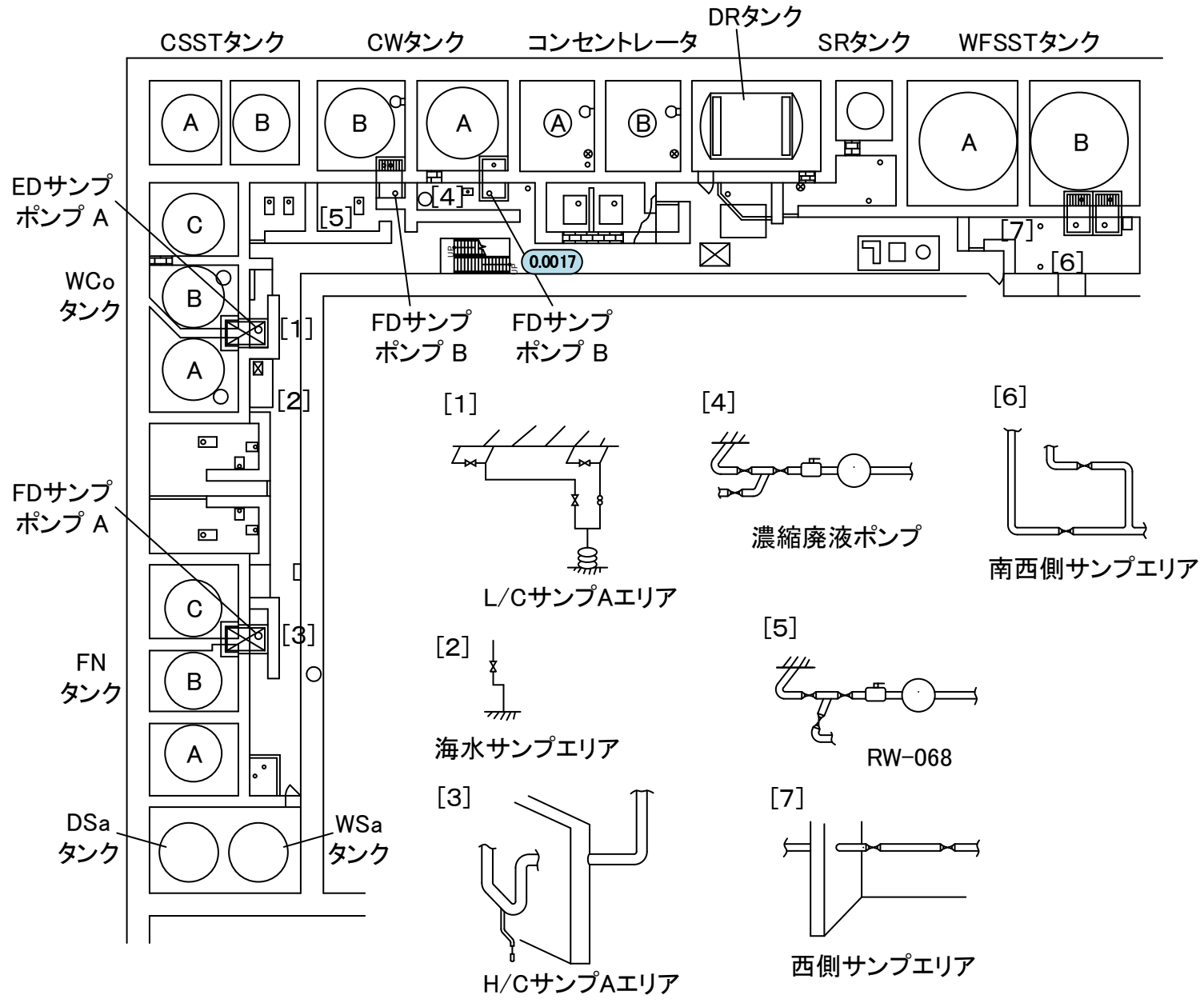

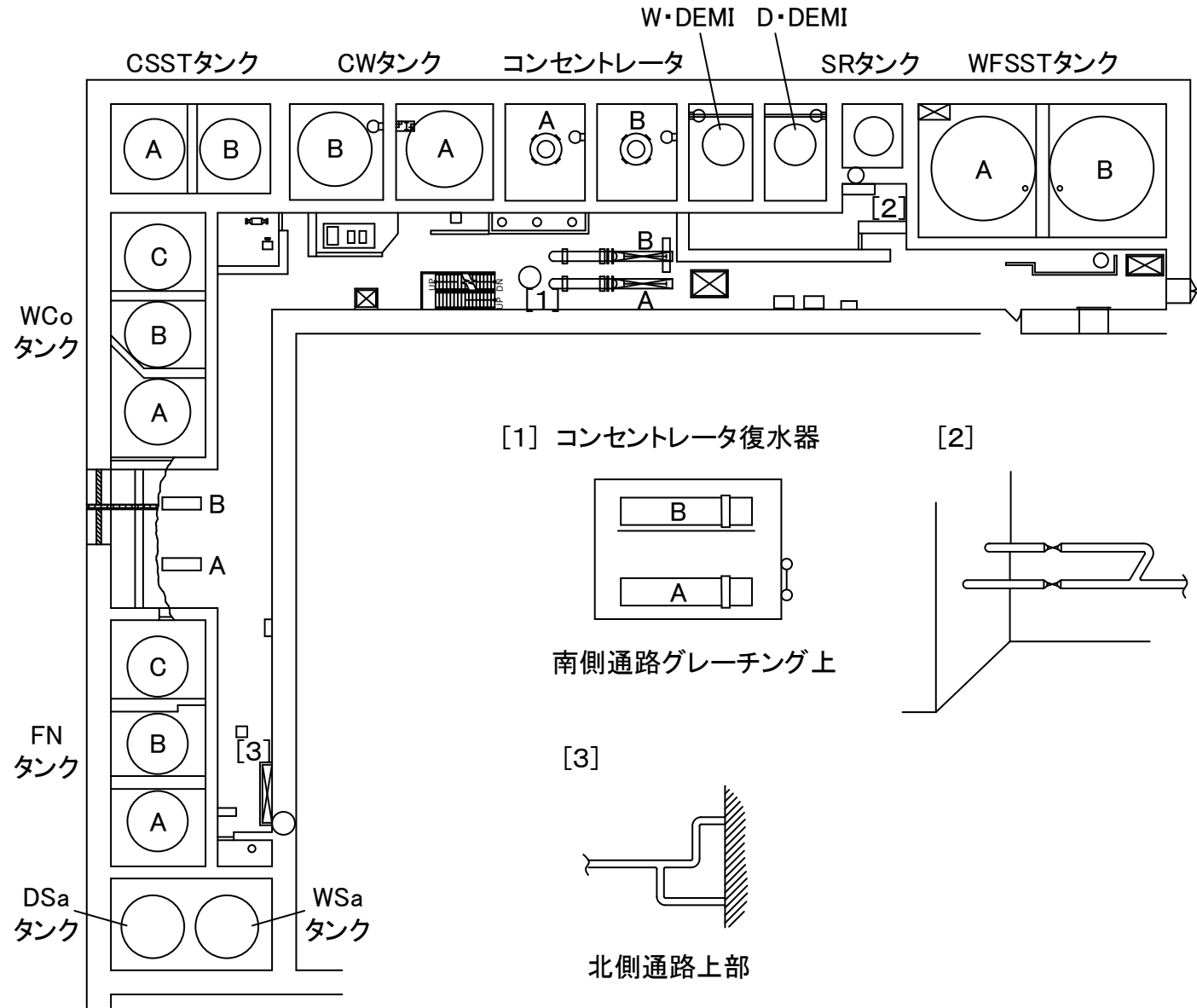

福島第一 原子力発電所

図面名称:

6号機 廃棄物処理建屋 中2階

[ 単位: mSv/h ]

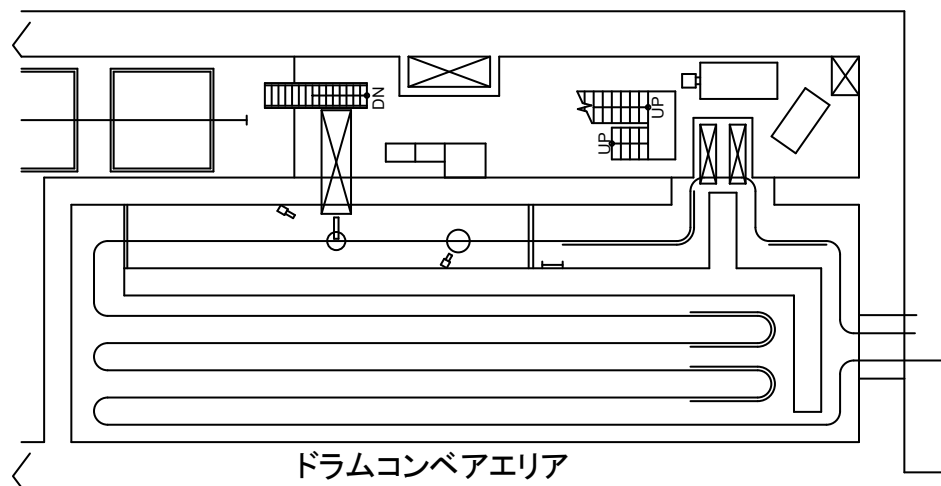

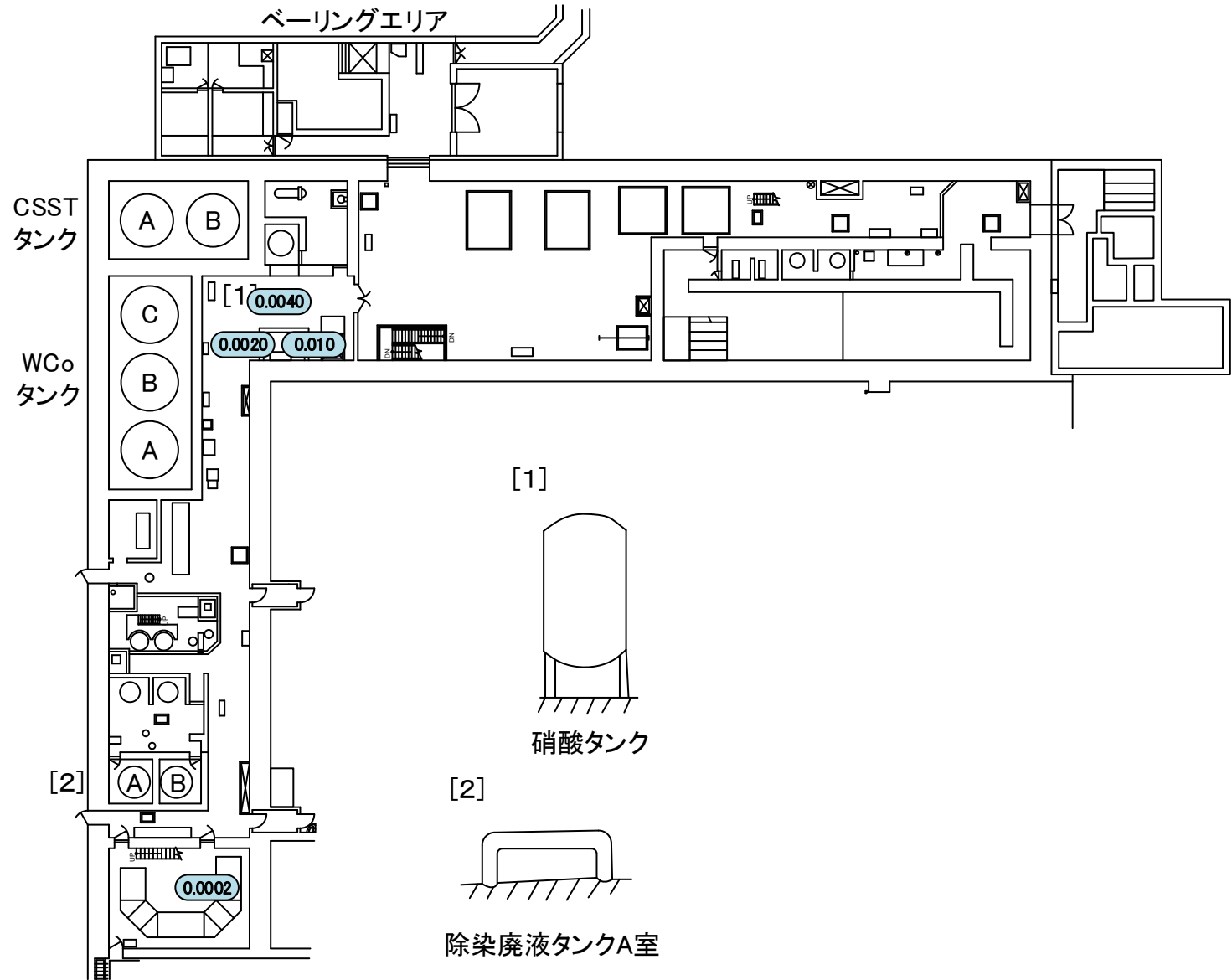



福島第一 原子力発電所	図面名称: 6号機 廃棄物処理建屋 2階	〔 単位: mSv/h 〕
-------------	----------------------	---------------

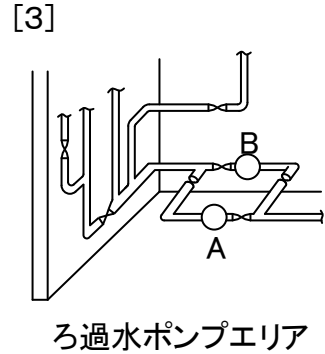
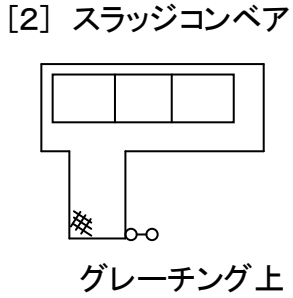
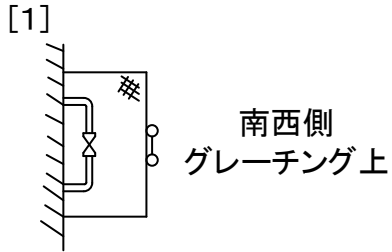
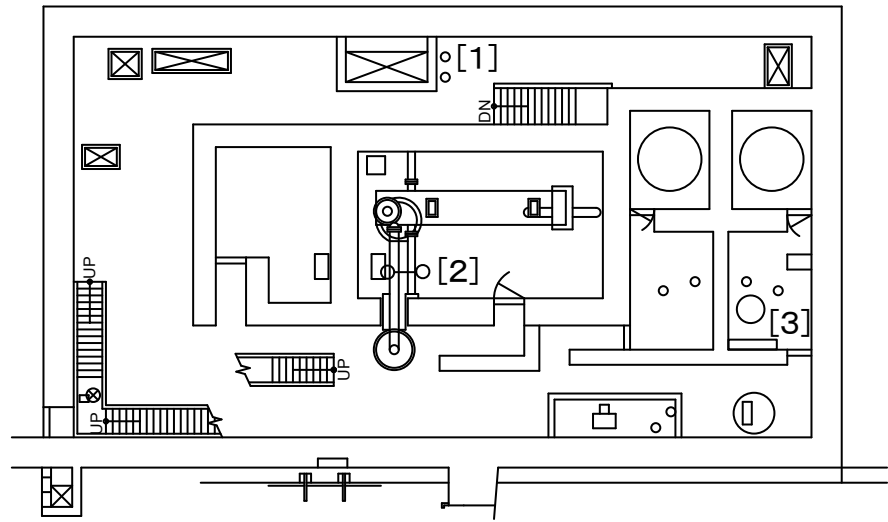

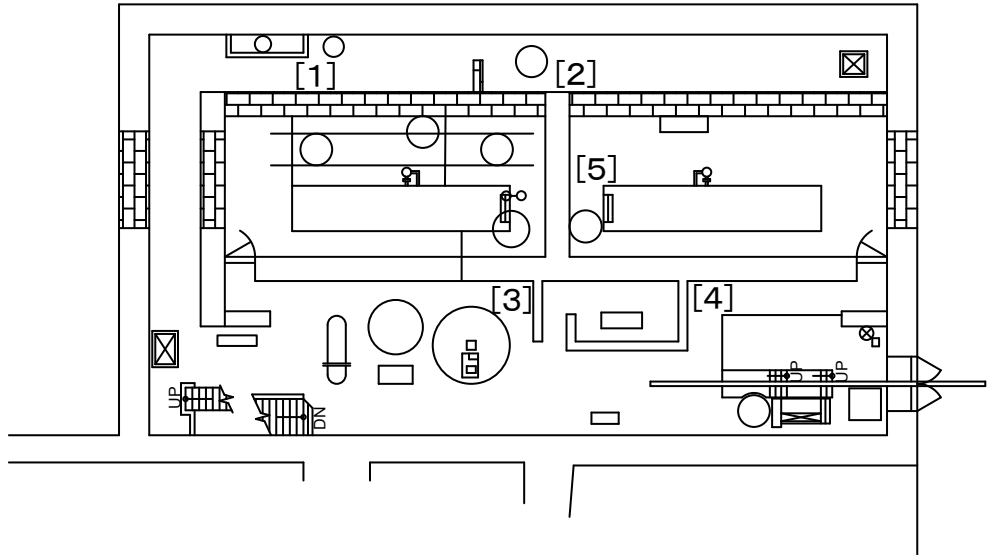

<D/G室>

非常用 D/G室
HPCS D/G室

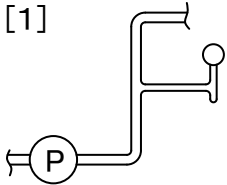

機器ドレン補助ろ過器ポンプ

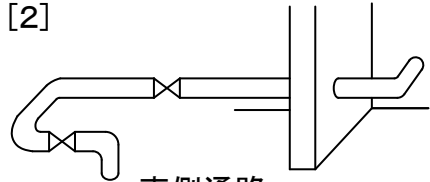

東側通路

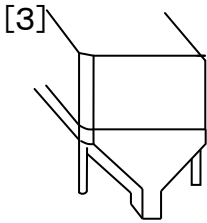

機器ドレンTBF

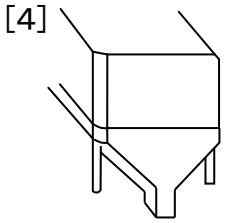

床ドレンTBF

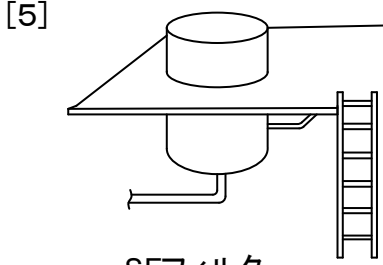

SFフィルター