

January 29, 2016
Tokyo Electric Power Company

Air Dose Rates inside the Buildings

Sampling Period

Unit 4: from November 1, 2015 to November 30, 2015

Fukushima Daiichi NPS

Unit 4 Reactor Building Semi-Basement Floor

[mSv/h]

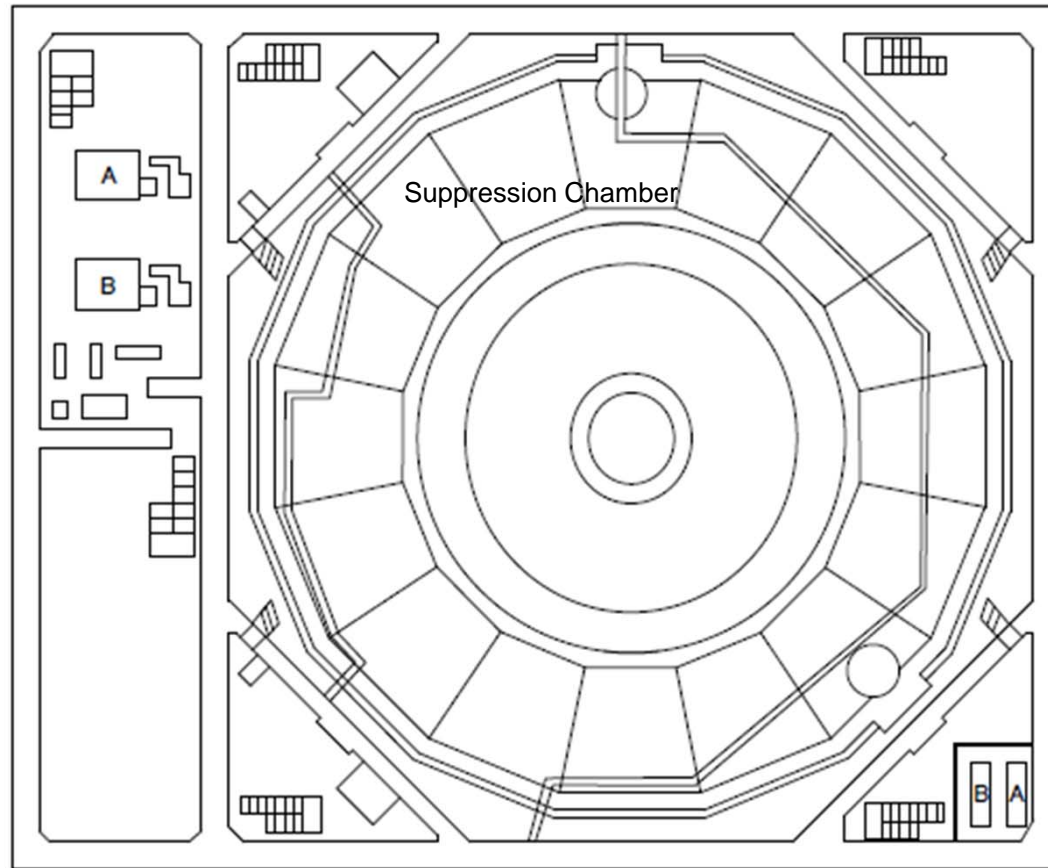

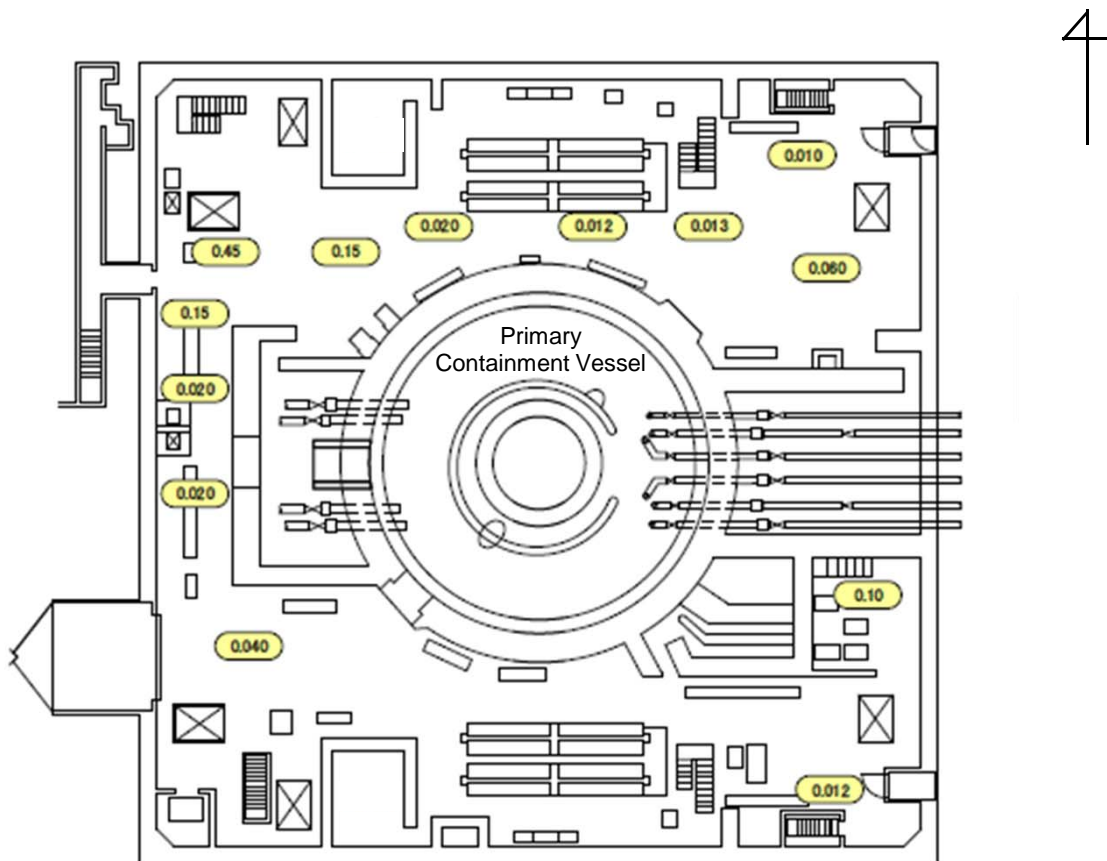

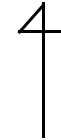
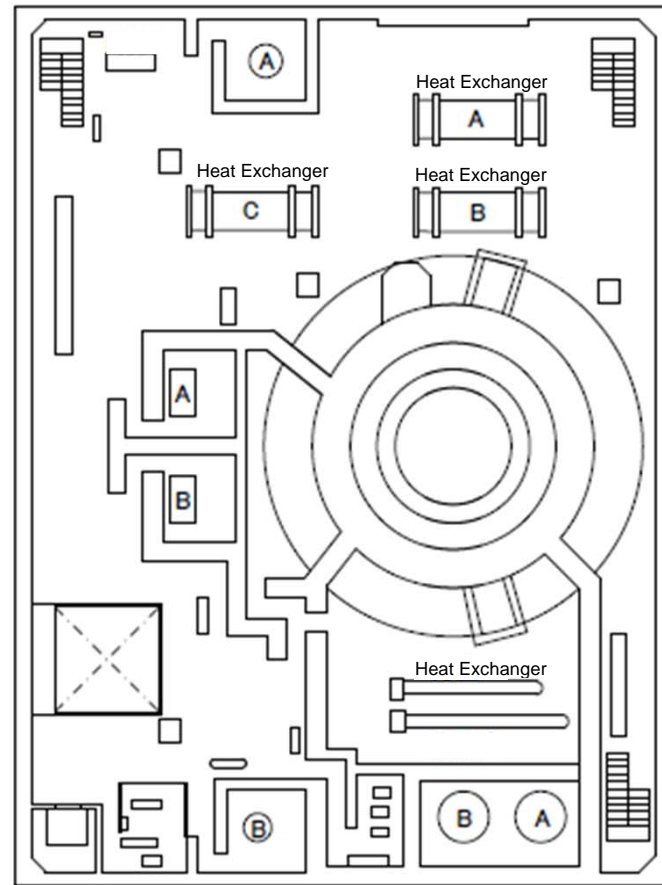

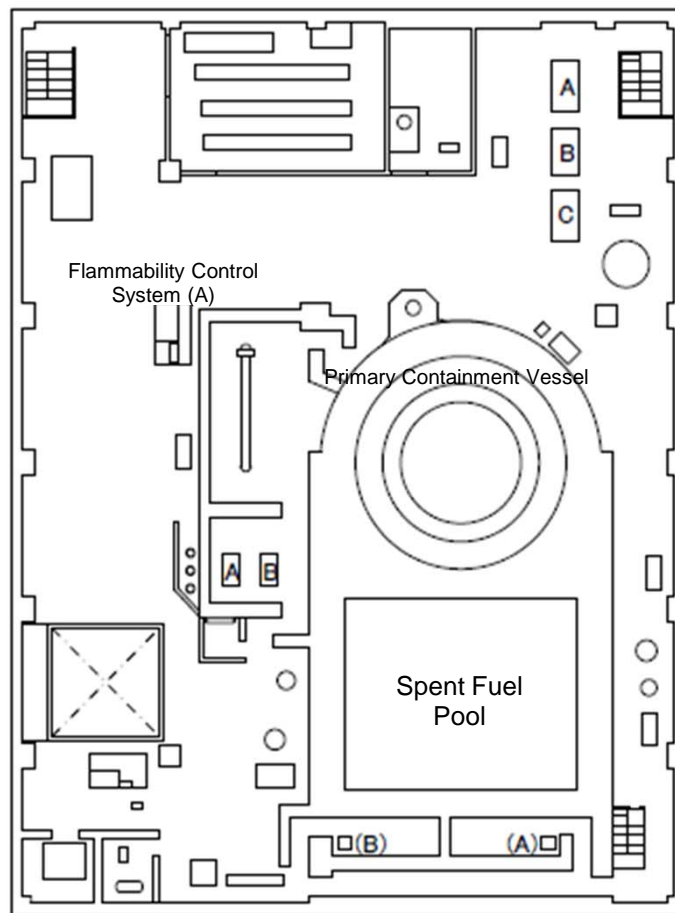

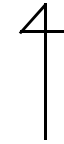
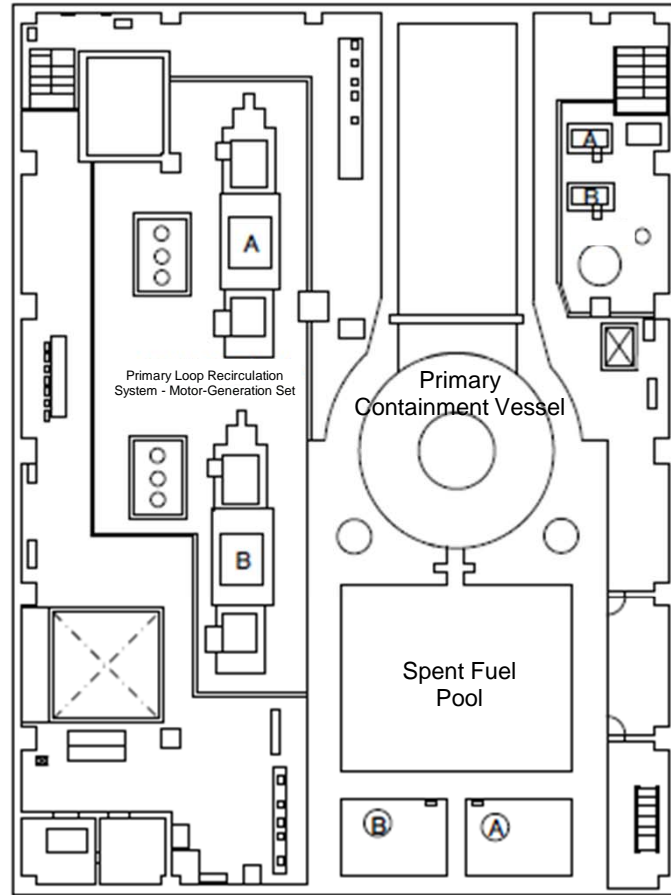

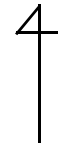
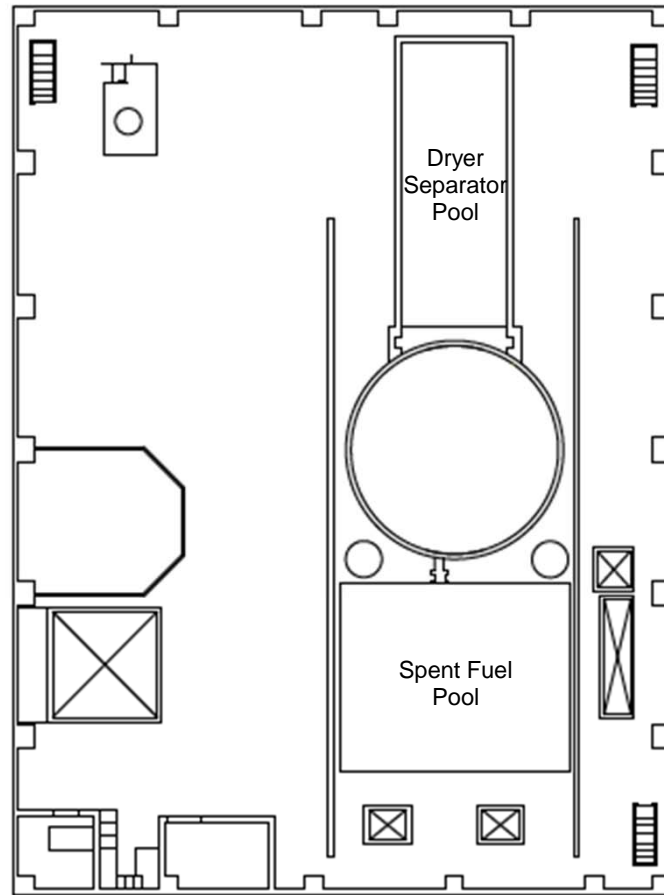

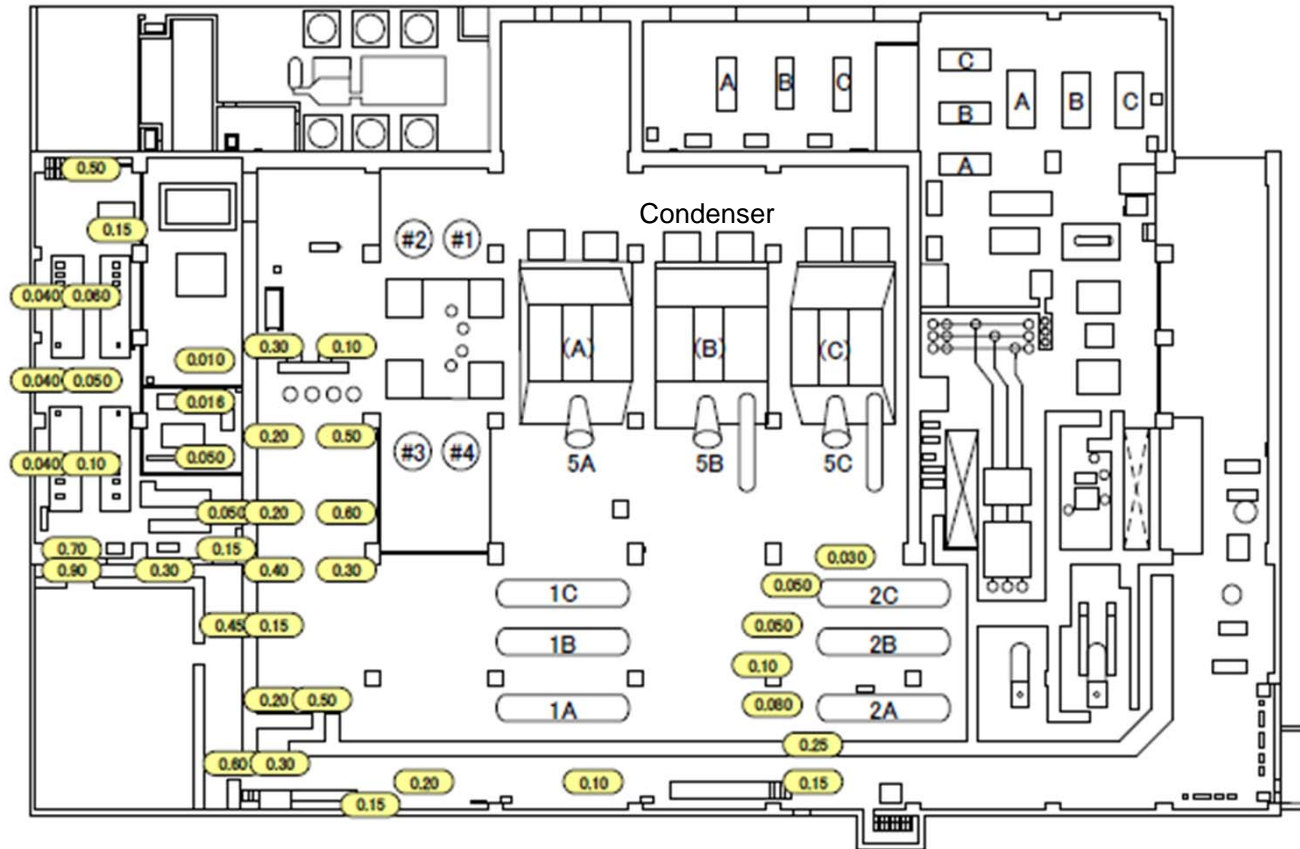
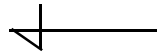

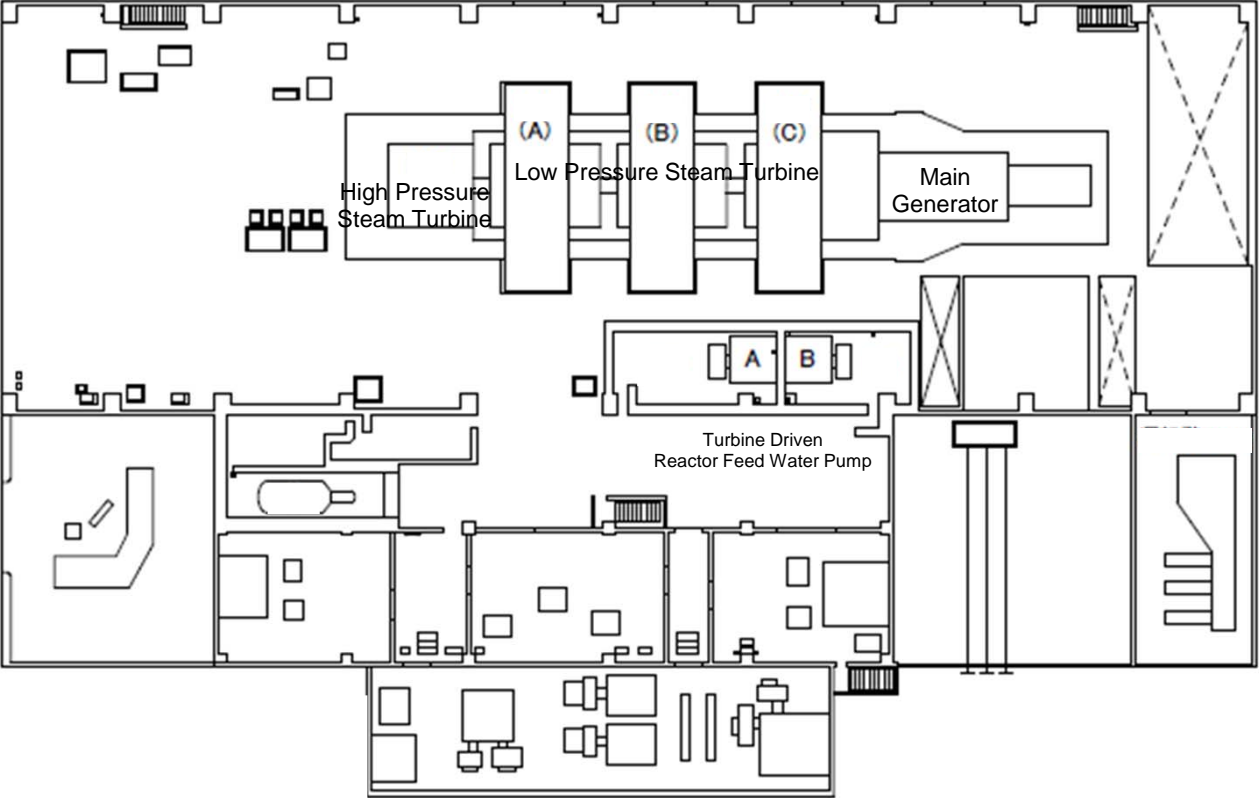
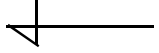

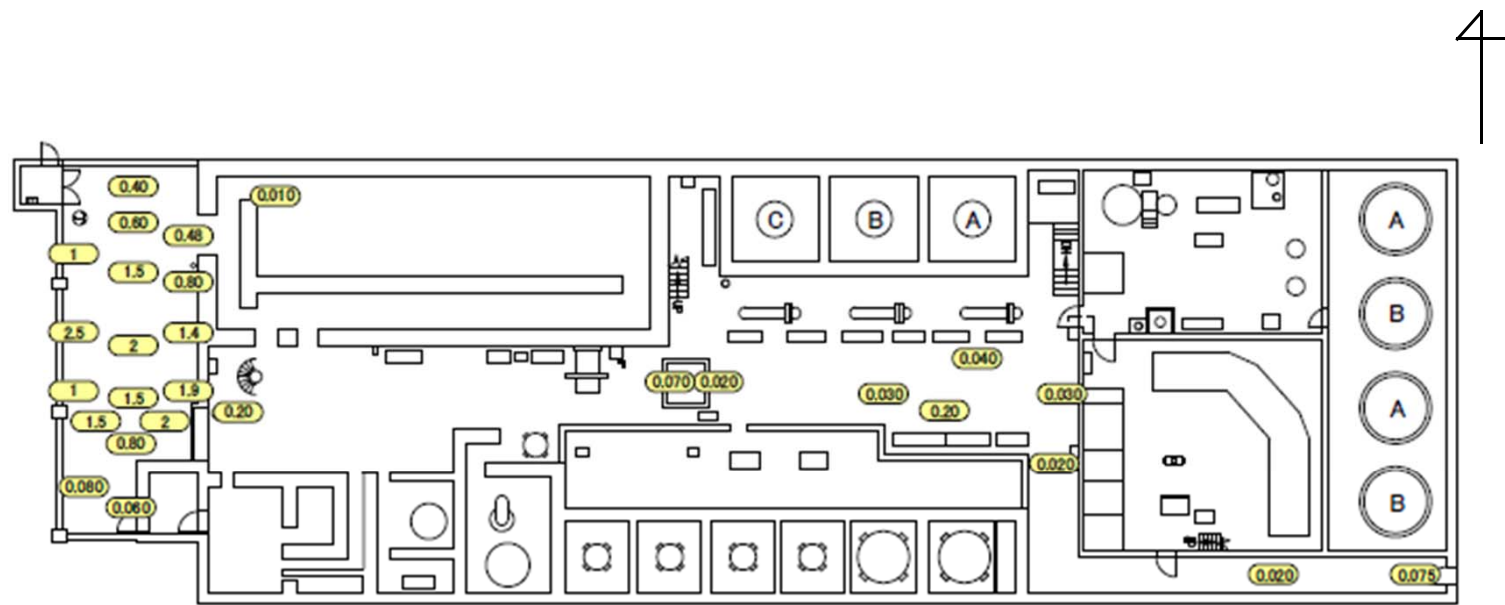

Fukushima Daiichi NPS	Unit 4 Radioactive Waste Treatment Facility 2nd Floor	[mSv/h]
-----------------------	---	---------

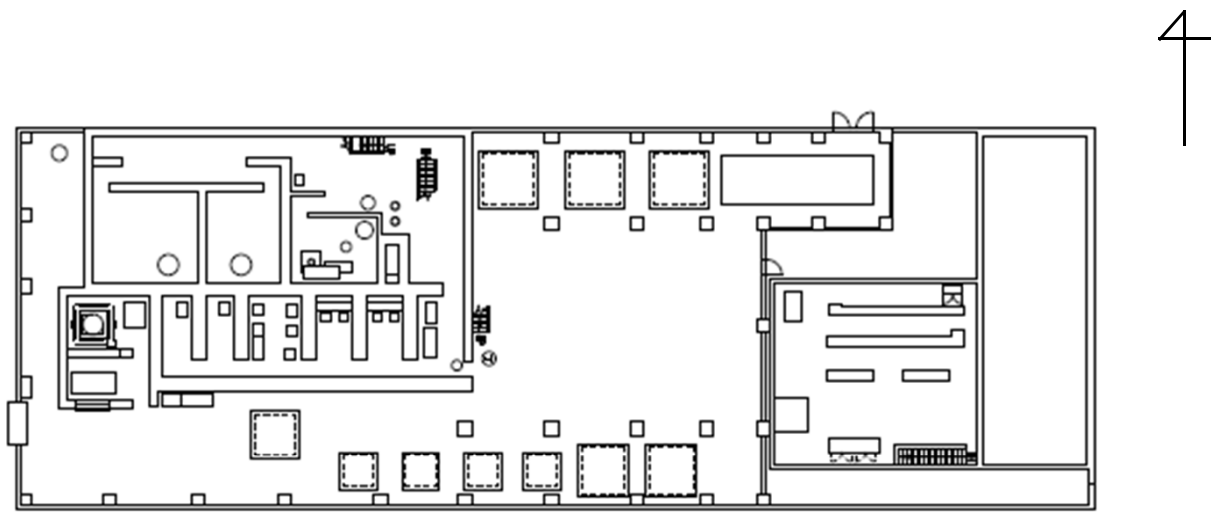

Fukushima Daiichi NPS	Unit 4 Radioactive Waste Treatment Facility 3rd Floor	[mSv/h]
-----------------------	---	---------

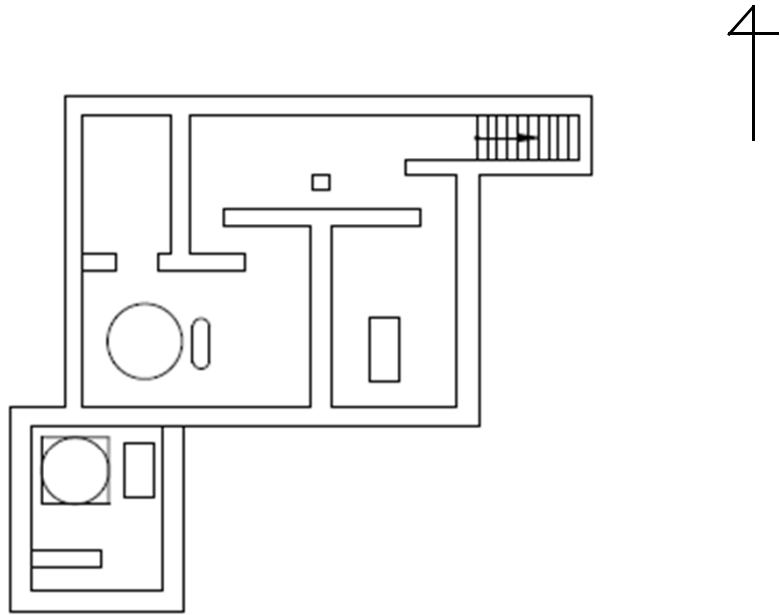

Fukushima Daiichi NPS

Unit 4 Radioactive Waste Treatment Facility 4th Floor

[mSv/h]

