

December 28, 2015  
Tokyo Electric Power Company

# Air Dose Rates inside the Buildings

Sampling Period

Unit 6: from October 1, 2015 to October 31, 2015

---

Fukushima Daiichi NPS

Unit 6 Reactor Building 2nd Basement Floor

[mSv/h]

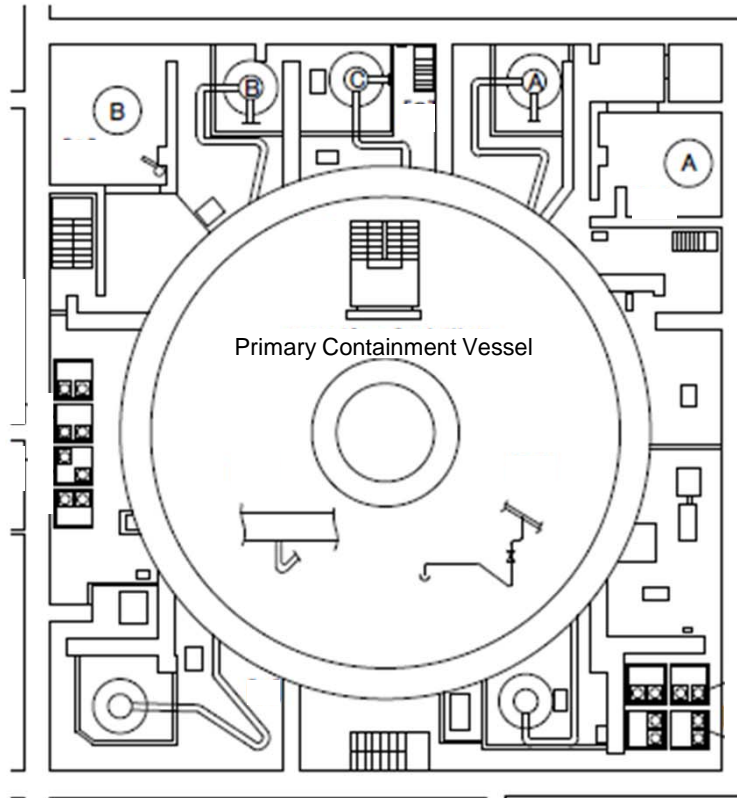
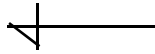

Fukushima Daiichi NPS

Unit 6 Reactor Building 1st Basement Floor

[mSv/h]

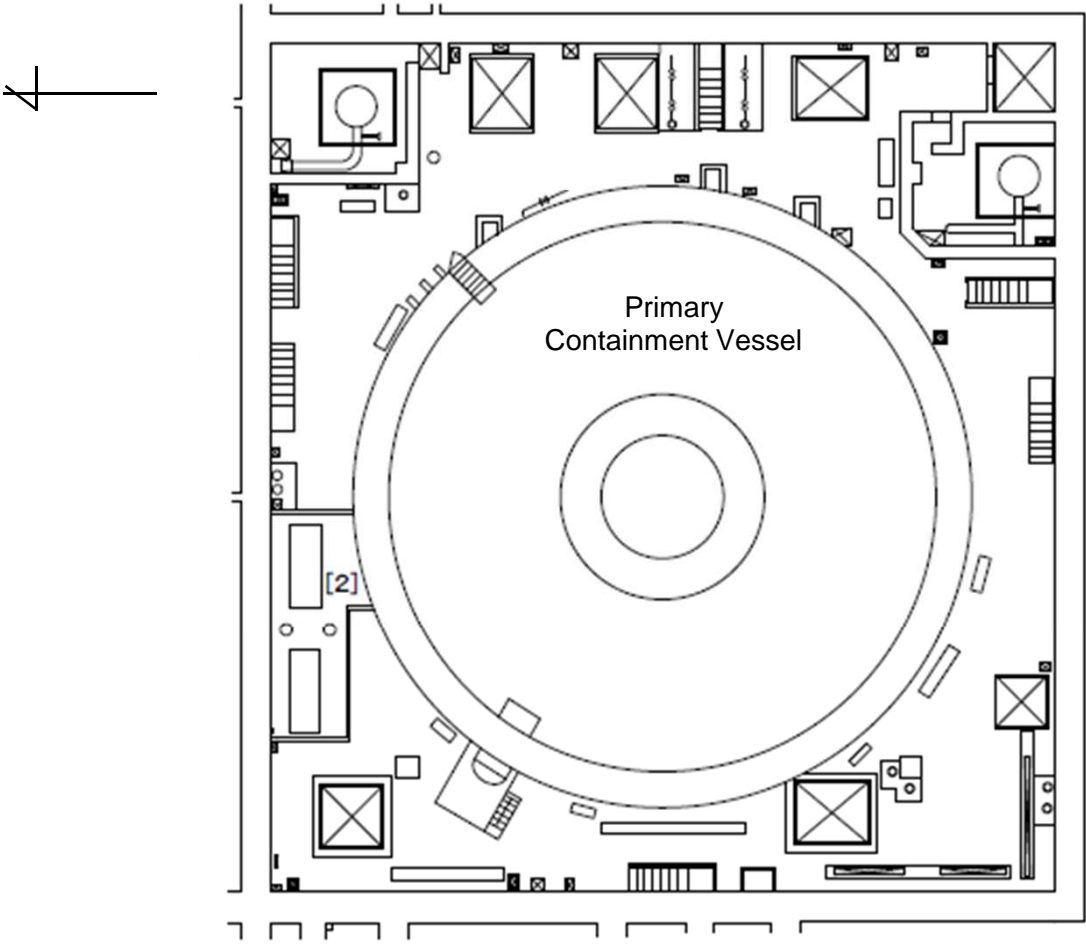

Fukushima Daiichi NPS

Unit 6 Reactor Building 1st Floor

[mSv/h]

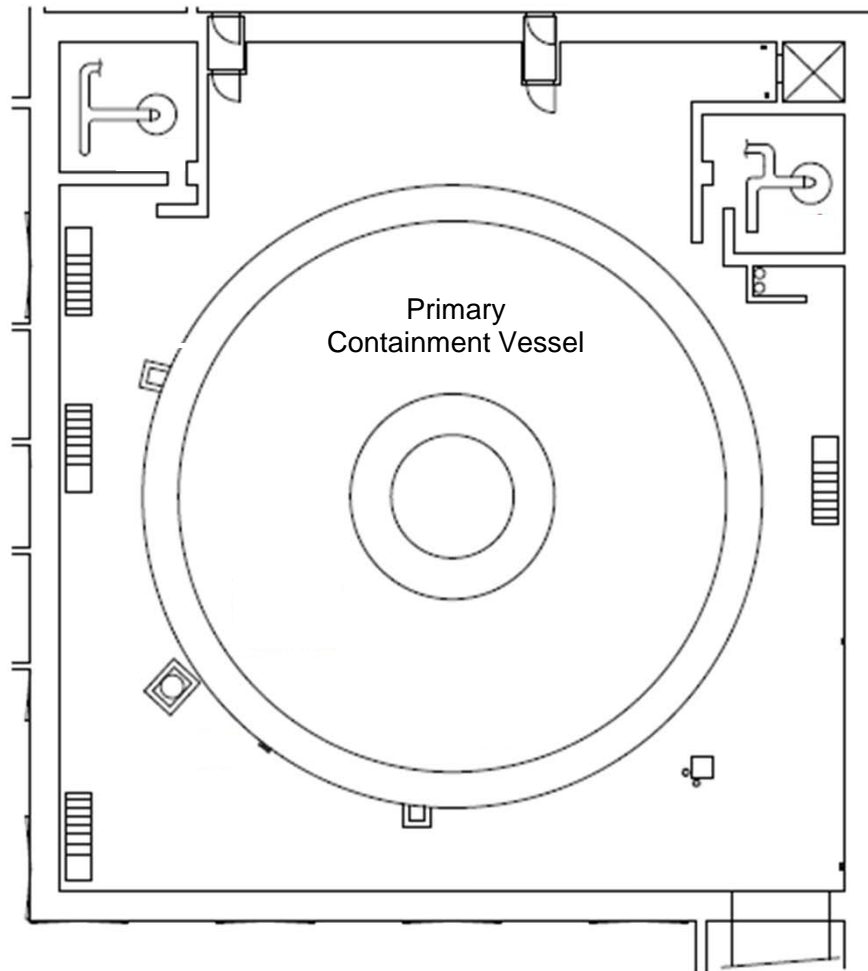
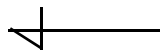

Fukushima Daiichi NPS

Unit 6 Reactor Building 2nd Floor

[mSv/h]

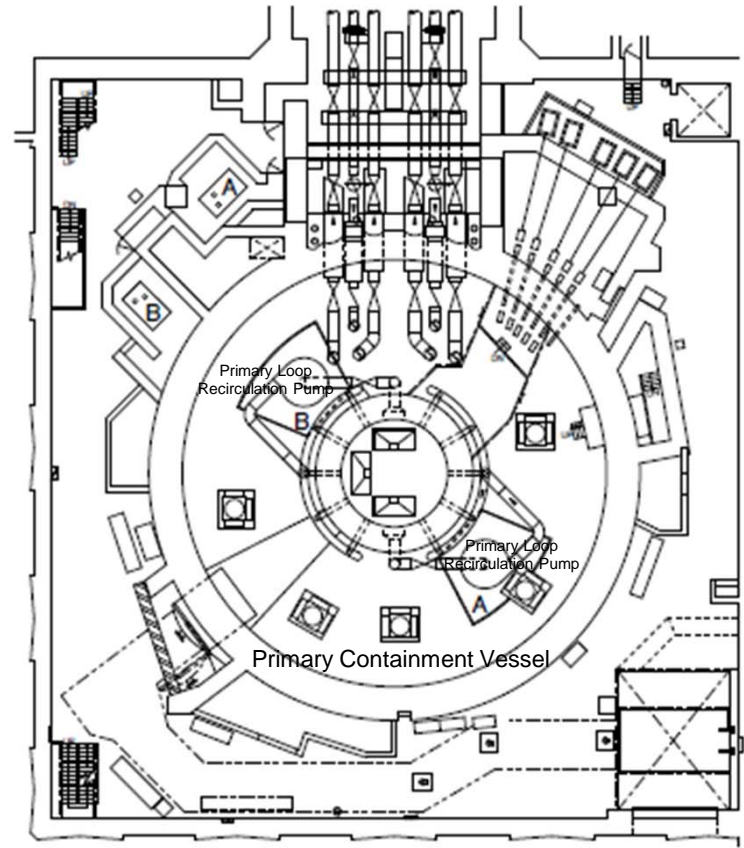
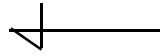

Fukushima Daiichi NPS

Unit 6 Reactor Building 3rd Floor

[mSv/h]

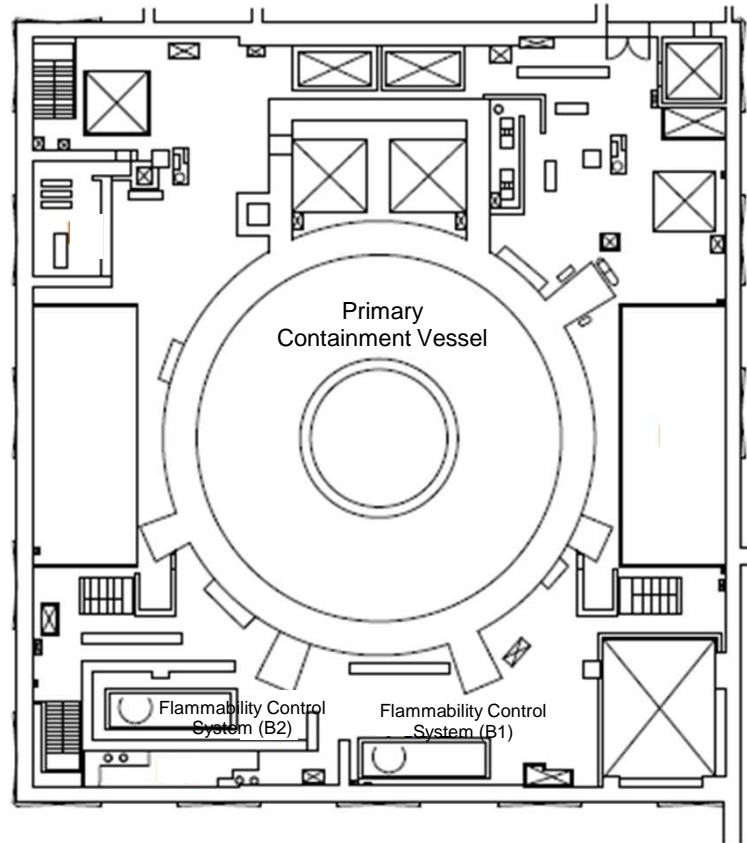
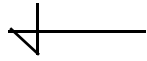

Fukushima Daiichi NPS

Unit 6 Reactor Building 4th Floor

[mSv/h]

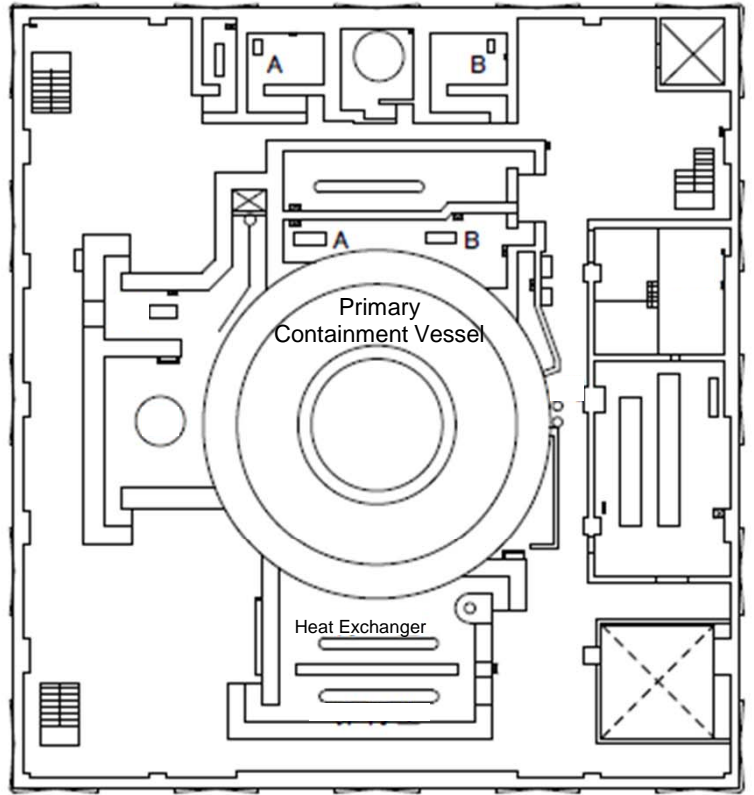
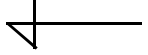

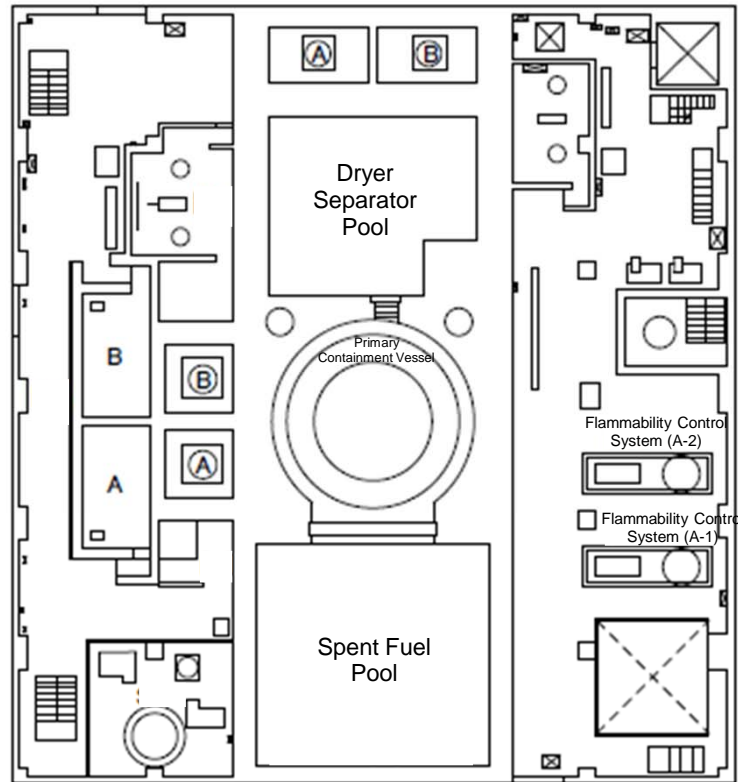
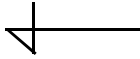



Fukushima Daiichi NPS

Unit 6 Reactor Building 6th Floor

[mSv/h]

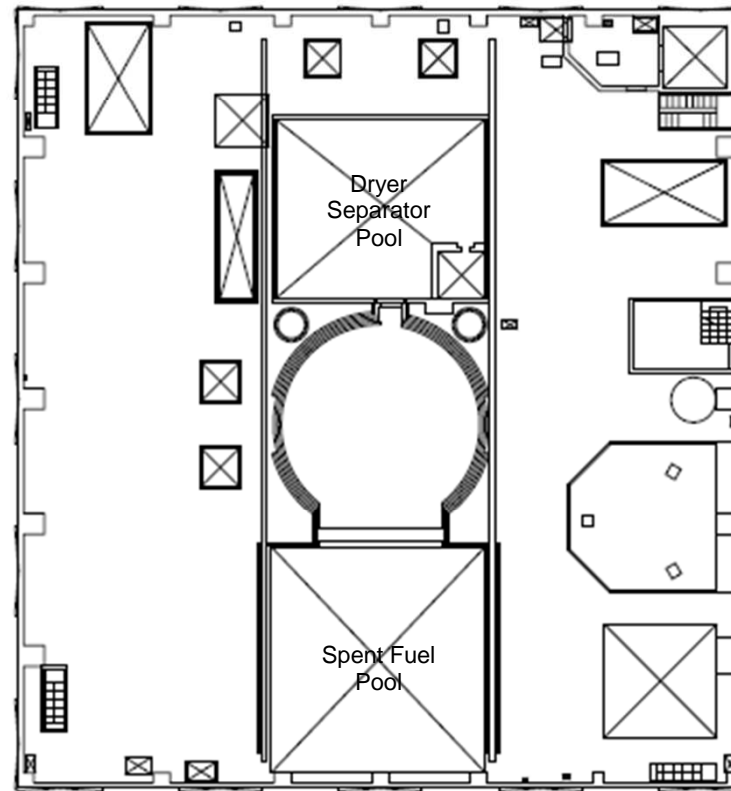
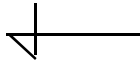

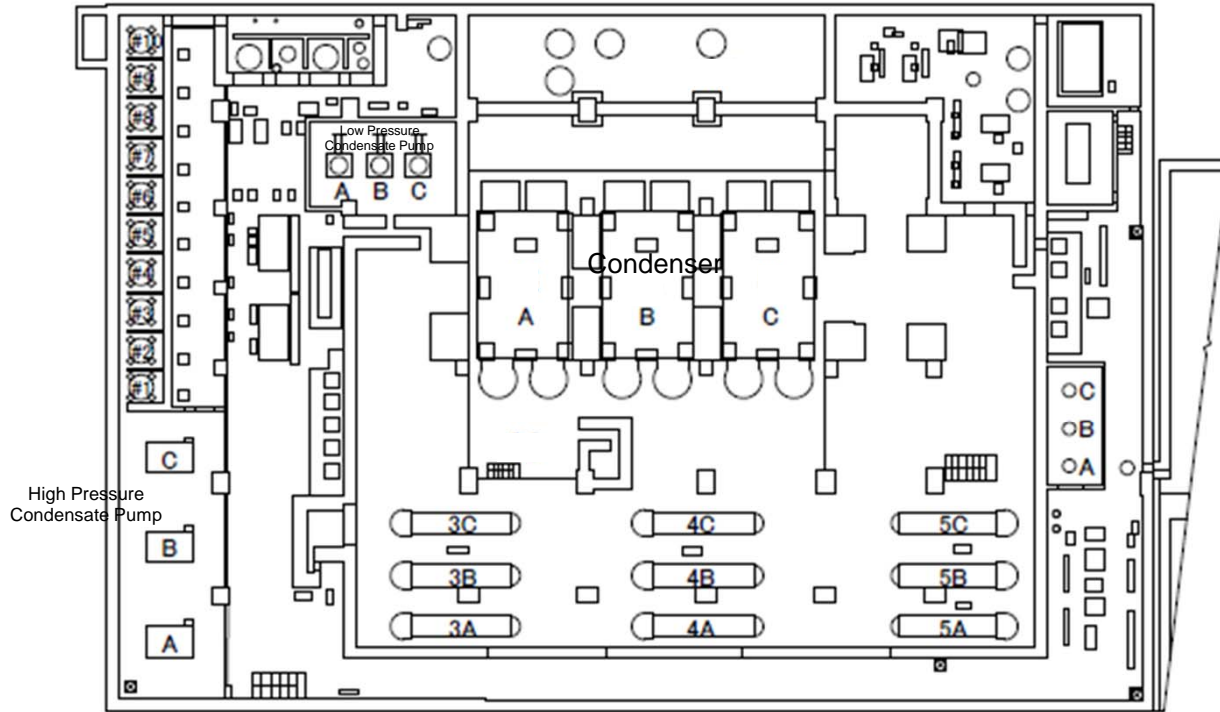
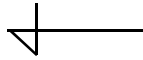

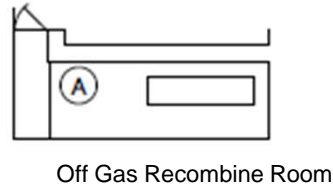
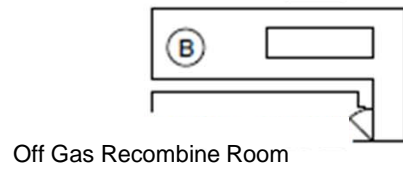
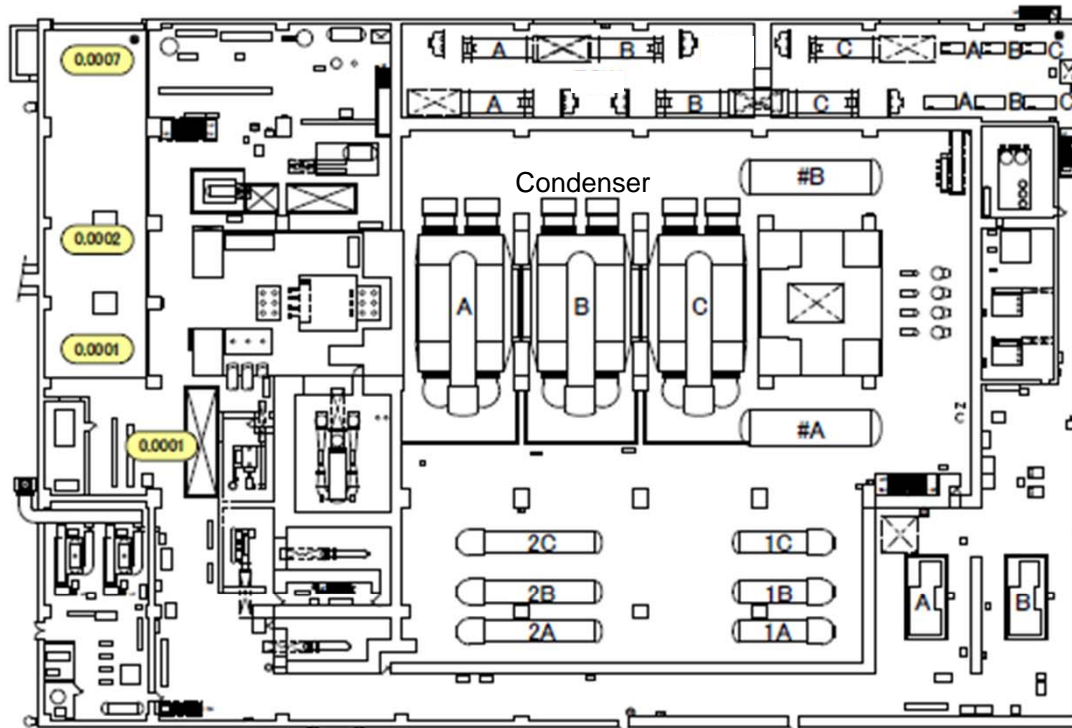
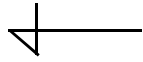

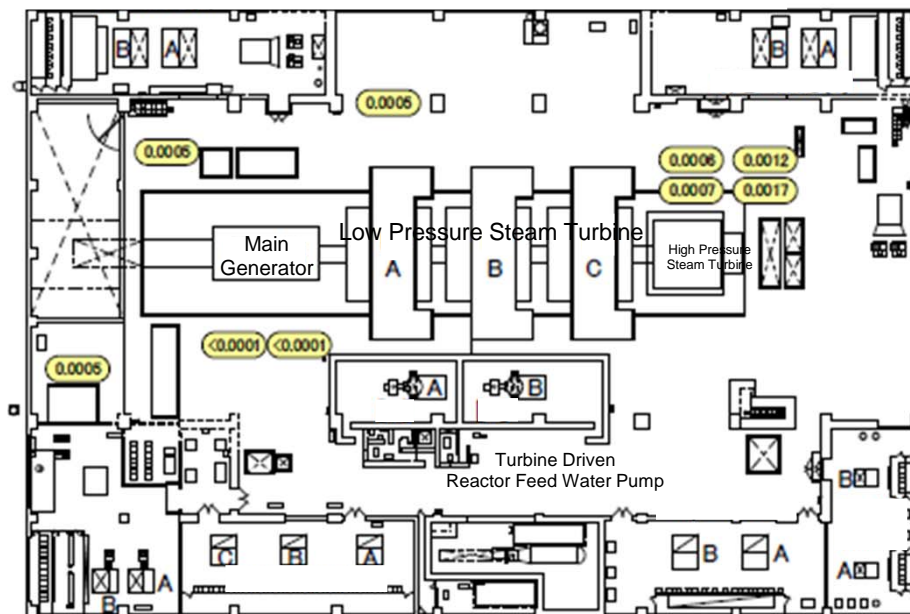
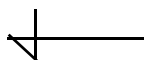

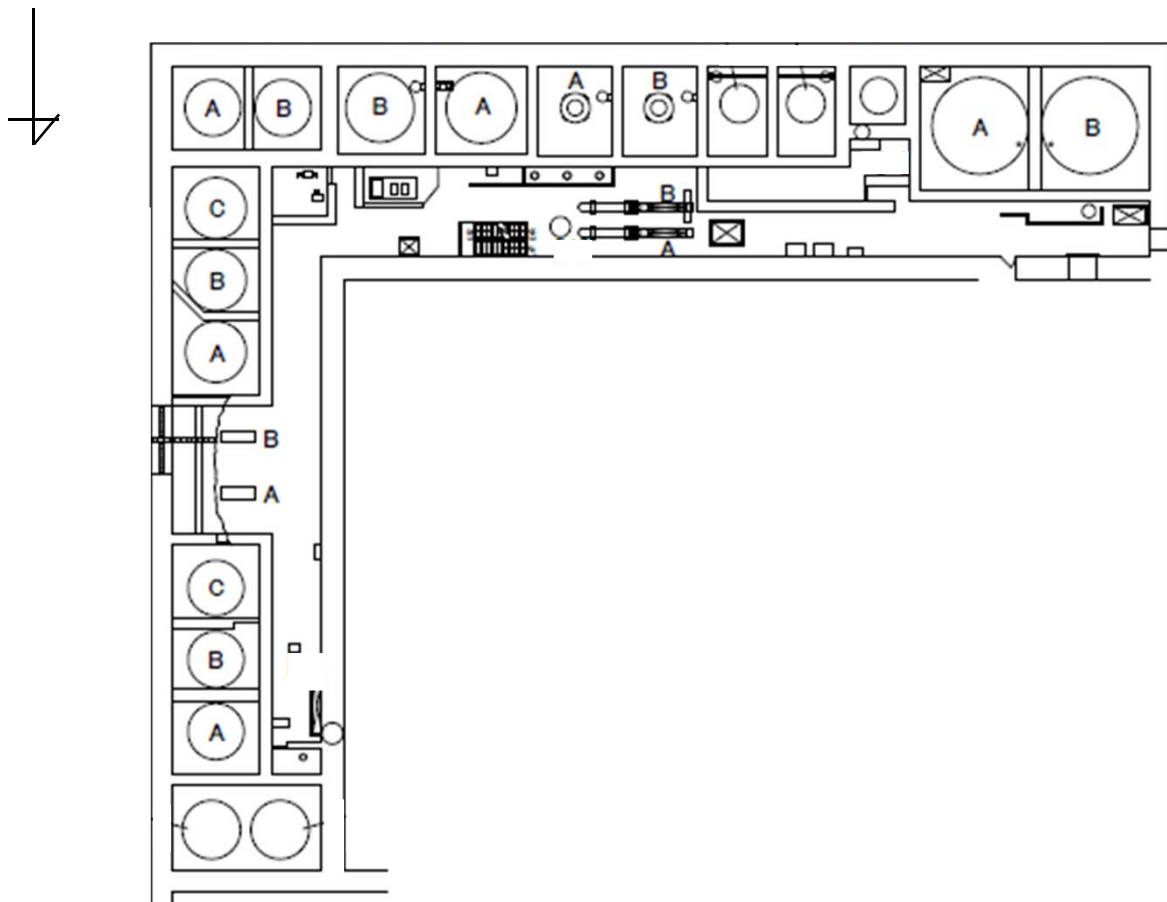

Fukushima Daiichi NPS

Unit 6 Radioactive Waste Treatment Facility 1st Floor

[mSv/h]

