

**Fukushima Daiichi Nuclear Power Station  
Leakage from the Contaminated Water Storage Facility RO Concentrated  
Water Reservoir  
(Final Report)**

Filed, June 2014  
Revised, October 2014  
Tokyo Electric Power Co., Inc.

## Introduction

On August 19, 2013, a pool of standing water not observed during a patrol the previous day was discovered both inside and outside of a dike at the RO concentrated water reservoir (H4 north tank) in the contaminated water storage facility at Fukushima Daiichi Nuclear Power Station (NPS). For that reason, as a result of confirming the situation, owing to the possibility that the water in the RO concentrated water reservoir (tank) leaked to areas inside and outside the dike at said reservoir, emergency countermeasures were implemented with respect to the event concerned based on the provisions of Fukushima Daiichi Regulations Article 18 to make assessments that falls under the category of accident report and to prevent the leakage from expanding. These details were reported to the Nuclear Regulation Authority (NRA) in Genkan-hakkan 25, No. 309 (dated August 28).

Also, the facts that the location of the tank leakage was determined and its direct cause inferred, that the trail of events regarding the operational management of the contaminated water tanks was ascertained, and what's more that countermeasures for dealing with these issues were devised were all reported to the NRA in Genkan-hakkan 25 No. 584 (dated December 6).

After this, based on the explanation of the reports that was given to the Nuclear Regulatory Agency (now the NRA) after the submission of December 6, 2013, a report to the NRA was made in Unsou-hakkan 26 No. 153 (dated June 30) that appended a chronology of the event's occurrence and a postscript regarding the details of the mechanism by which the leakage was inferred, and also collated the results of studies on the route and timing of the outflow of water based on an investigation of the impact the leaked contaminated water had within the site and on the ocean.

The present report is based on the explanation of the reports that was given to the Nuclear Regulatory Agency after the submission of June 30, 2014, as a revised report that includes a postscript and corrections about the state of progress with the countermeasures and the environmental impact investigation.

## Table of Contents

1. Subject .....	1
2. Date Event Occurred .....	1
3. Nuclear Power Reactor Facilities Where Event Occurred .....	1
4. Situation at Time When Event Occurred .....	1
5. Measures to Prevent Expansion of Tank Leakage (Emergency Countermeasures) .....	2
5-1. Measures to Prevent Expansion of Leakage from Tanks Concerned .....	2
5-2. Enhanced Monitoring Around Tanks .....	4
5-3. Results of Spot Inspections on Similar Tanks and Risk Reduction Strategies .....	5
5-4. Results of Usage Investigation and Risk Reduction Strategies .....	5
6. Environmental Impact Investigation Results (Spread of Contaminated Water) .....	6
6-1. Assessing Amount of Water Leaked from Tanks .....	6
6-2. Results of Investigation on Groundwater Impact .....	7
6-2-1. Investigation of Radiation Dose on Ground Surface .....	7
6-2-2. Soil Contamination Condition Investigations Through Hole Boring .....	7
6-2-3. Groundwater Quality Analysis .....	9
6-2-4. Assessing Amount of Radioactive Materials Collected .....	10
6-3. Results of Investigation into Impact on Drainage Ditches .....	10
6-4. Results of Investigations into Impact on Ocean .....	11
7. Root Causes Investigation Content and Results .....	11
7-1. Results of Investigation into Locations of Tank Leaks (pre-dismantling) .....	11
7-2. Results of Investigation into Locations of Tank Leaks (during dismantling) .....	13
7-3. Results of Investigation into Locations of Tank Leaks (after dismantling) .....	14
7-4. Some Considerations Regarding the Investigation Results .....	15
8. Circumstances Related to Operations Management .....	18
9. Countermeasures .....	19
10. Attachments .....	23

1. Subject  
Fukushima Daiichi Nuclear Power Station  
Leakage from the Contaminated Water Storage Facility RO Concentrated Water Reservoir
2. Date Event Occurred  
August 19, 2013, 2:28 p.m.  
(time assessed as falling under Fukushima Daiichi Regulations Article 18, item 12)
3. Nuclear Power Reactor Facilities Where Event Occurred  
Contaminated water processing equipment, storage facility (tanks, etc.), mid-low concentration tank, RO concentrated water reservoir

4. Situation at Time When Event Occurred

At around 9:50 a.m. on August 19, 2013, the working patrolling the site of the contaminated water storage facility discovered that there was standing water inside the dike (hereinafter, "the dike concerned") installed surrounding the RO concentrated water reservoir of area H4 north (steel cylindrical-model tank; flange bolt-sealed type), as well as standing water in two locations outside the dike concerned.

Also, after having confirmed at the two locations (normally operated at "open"<sup>1</sup>) where drain valves used for rainwater drainage (hereinafter "drain valves") are installed in the dike concerned that the water standing inside said dike was running to outside said dike, the two drain valves where outflow was confirmed and one neighboring drain valve were closed.

At the time the standing water situation was confirmed, the depth of the water inside the dike was ascertained to be approximately 1 cm, while the two pools outside the dike were ascertained respectively to be approximately 3 m × 3 m in area with a depth of approximately 1 cm and approximately 0.5 m × 6 m in area with a depth of approximately 1 cm.

While the worker was confirming the on-site situation, an alarm (set points: beta radiation 5 mSv, gamma radiation 0.8 mSv) sounded from the alarmed portable dosimeter (hereinafter, "APD") that the worker carried. The ambient dose equivalent rate of the standing water outside the dike concerned was measured, and a dose rate<sup>2</sup> was confirmed that at maximum exceeded 98.5 mSv/h (70 μm dose equivalent rate [beta radiation]).

Subsequently, a visual check was made of the external appearance of RO concentrated water reservoir 26 installed in area H4 north. However, since no anomalies such as cracks or leaks were confirmed on the surface of the tank, a determination as to the root cause for the standing water to have been produced was not reached.

Although the root cause for the production of standing water could not be determined, because the water that had pooled within the dike in question had leaked through the drain valve to outside the dike, and because the radiation dose in the standing water outside the dike was measured to be high, it was decided that there was the possibility that the RO concentrated water accumulated in the H4 north area RO concentrated water reservoir had leaked out. It was thus decided at 2:28 p.m. on August 19 that this came under Fukushima Daiichi Regulations Article 18, item 12, "A case when nuclear fuel material (not in the form of gas) or the like has leaked within an area controlled by the company due to an unpredictable events such as a failure of a nuclear reactor facility for power generation."

Furthermore, while standing water was present inside the dike concerned at around 5 p.m. on August 18 when the on-site patrol was conducted, standing water of clearly noticeable levels was not confirmed outside the dike. Additionally, it was confirmed that no rainfall was detected with the precipitation sensors installed on the grounds of the power station between around 5 p.m. on August 18 and the point when standing water was discovered.

With regard to the water standing within the dike concerned, a temporary pump and temporary tank were installed and approximately 4 m<sup>3</sup> of water was collected with this from 7 p.m. to midnight

---

1 In the "Regarding responses to leaks of water including radioactive materials from desalination unit-equipped concentrated water reservoirs at Fukushima Daiichi NPS (reports)" (April 5, 2012) submitted in response to the directive from the now-defunct Nuclear and Industrial Safety Agency, a report stating "a separation valve will be installed in the water catchment box so that stormwaters do not build up, and in the unlikely event that leakage from the tank is confirmed it will be quickly closed" and the unit normally operated at "open."

2 Upper measurable limit of measuring equipment

on August 19. When the inside of the dike concerned was checked at around 1 a.m. on August 20, it appeared that the standing water was spreading from the vicinity of RO concentrated water reservoir No. 5 (hereinafter "the tank concerned") in the area H4 north cluster I. Furthermore, when a check was made around 7 a.m. on August 20, the depth of the standing water was confirmed to have risen to approximately 3 cm.

Also, when the top cover of the tank concerned was opened at around 7 a.m. on August 20 and a visual check made, the observer confirmed that the surface of the water that originally should have been approximately 0.5 m below the ceiling had in fact fallen to approximately 3 m below.

RO concentrated water reservoir No. 5 in the area H4 north cluster I is connected with linked ductwork. When RO concentrated water is received, it is done so with the valve on the linked ductwork opened so that the level of the water in said reservoir remains uniform. After the water has been received, the valve on said ductwork is closed.

Subsequently, the top covers were opened on the tank concerned and at four other RO concentrated water reservoirs in the area H4 north cluster I (nos. 7-10) and the water levels measured (using a tape measure to check the distance from the tank ceiling to the water surface). In contrast to distances of 0.5 m to 0.6 m from the ceiling to surface in the other four tanks, the water surface in the tank concerned was at a position approximately 3.4 m from the ceiling. For that reason, it was decided at 9:40 a.m. on August 20 that the root cause for the standing water to have been produced was leakage of RO concentrated water from the tank concerned. Furthermore, the tank water levels were measured in the same fashion in the tanks near the standing water inside the same dike and it was confirmed that there were no anomalies.

Since the drawdown in the tank concerned was approximately 3 m, the volume of leakage was confirmed to be approximately 300 m<sup>3</sup> (tank inside diameter of 12 m). When considering the recovered amount of water standing inside the dike concerned and the amount of standing water confirmed as outside the dike concerned, the possibility was presumed to be high that the bulk of the RO concentrated water that leaked from the tank concerned flowed to outside of the dike concerned and seeped into the soil.

The densities of radioactive materials in the water standing inside the dike in question collected on August 19 were Cs-134 at  $4.6 \times 10^1$  Bq/cm<sup>3</sup>, Cs-137 at  $1.0 \times 10^2$  Bq/cm<sup>3</sup>, Co-60 at  $1.2 \times 10^0$  Bq/cm<sup>3</sup>, Mn-54 at  $1.9 \times 10^0$  Bq/cm<sup>3</sup>, Sb-125 at  $7.1 \times 10^1$  Bq/cm<sup>3</sup>, H-3 at  $2.1 \times 10^3$  Bq/cm<sup>3</sup>, and gross beta at  $2.8 \times 10^5$  Bq/cm<sup>3</sup>. Furthermore, the densities for water from the tank concerned collected on August 23 were Cs-134 at  $4.4 \times 10^1$  Bq/cm<sup>3</sup>, Cs-137 at  $9.2 \times 10^1$  Bq/cm<sup>3</sup>, Co-60 at less than the measurable limit (measurable limit:  $3.8 \times 10^0$  Bq/cm<sup>3</sup>), Mn-54 at less than the measurable limit (measurable limit:  $5.2 \times 10^0$  Bq/cm<sup>3</sup>), Sb-125 at  $5.3 \times 10^1$  Bq/cm<sup>3</sup>, Sr-90 at  $1.5 \times 10^5$  Bq/cm<sup>3</sup>, H-3 at  $2.4 \times 10^3$  Bq/cm<sup>3</sup>, and gross beta at  $4.1 \times 10^5$  Bq/cm<sup>3</sup>.

During the on-site check performed the day the event occurred, no water was confirmed as flowing in drainage ditch B running from area H4 north on its east side, or on the surface of the ground from area H4 north to the grit chamber on the southeast side. However, when surface dose equivalent rate around area H4 north was measured, it was confirmed that there was a point on the surface of the ground (near drainage ditch B) outside the sandbag dike installed around area H4 north with a maximum rate of 95.55 mSv/h (70  $\mu$ m dose equivalent rate [beta radiation]) (Attachment-3, measurement point 11).

Also, in the on-site check performed August 21, traces running with a striped appearance were observed on the concrete wall of drainage ditch B. The dose equivalent rate on the surface of the concrete wall was measured and found to be at maximum 5.80 mSv/h (70  $\mu$ m dose equivalent rate [beta radiation]) (Attachment—3, measurement point 53). This confirmed the possibility that contaminated dirt had run into the drainage ditch.

As yet, no significant changes have been confirmed in the monitoring post indicators either before or after the event occurred.

(Attachment—1, 3)

## 5. Measures to Prevent Expansion of Tank Leakage (Emergency Countermeasures)

### 5-1. Measures to Prevent Expansion of Leakage from Tanks Concerned

#### (1) Measures to Prevent Leakage from Tanks Concerned

To prevent leakage of the RO concentrated water stored in the tank concerned, from 9:55 p.m. on August 20 to 9:13 p.m. on August 21 RO concentrated water was transferred using a

temporary pump to RO concentrated water reservoir tank No. 10 installed in area H4 north cluster B.

(Attachment—2)

(2) Measures to Prevent Expansion of the Extent of Leakage Inside the Dike Concerned

To prevent expansion of the extent of leakage inside the dike concerned, water absorbing mats were positioned on August 19 at those spots where leakage from the tank concerned was striking and sandbags were positioned in the surrounding area. What's more, work was done to prevent expansion of the extent of leakage by recovering the contaminated water that had leaked, identifying the leakage locations, and then gradually reducing the extent of the area sectioned off by sandbags.

Also, the water standing inside the sandbags placed around the tank concerned was intermittently recovered into a temporary tank. From 9:55 p.m. on August 20 to 3 p.m. on August 22, approximately 8 m<sup>3</sup> of the water collected in the temporary tanks was transferred using a temporary pump to RO concentrated water reservoir tank No. 10 installed in area H4 north cluster B.

(Attachment—1)

(3) Measures to Prevent Expansion of Leakage Around Area H4 North

Owing to the high possibility that the bulk of the contaminated water that leaked from the tank concerned flowed to outside of the dike concerned and seeped into the soil, and to the fact that there was a point on the ground outside the sandbag dike installed around area H4 north where the radiation dose was measured to be high, the following emergency countermeasures were undertaken on August 20 to prevent expansion of the leakage around area H4 north and outflow into drainage ditch B.

- a. To prevent leakage from spreading from gaps in the sandbag dike, earth fill was poured on the front and back faces of the sandbag dike.
- b. To prevent leakage from spreading from locations where sandbag dikes have not been installed, earth-fill dikes made of earth fill (some of which is sandbagging) and seepage control sheets were installed.
- c. To prevent leaked contaminated water and dirt from flowing into the drainage ditches due to rainwaters seeping into the soil, seepage control sheets and vinyl tarpaulin were placed on the route running up to the point outside the sandbag dike where the radiation dose was measured as high.

(Attachment—2)

(4) Collection of Contaminated Soil

Results of radiation dosage measurements made of the surface inside the dike surrounding the tank concerned and the surface of the ground outside the dike concerned confirmed the presence of a contaminated area running from the leaking tank to the side ditch (drainage ditch B).

For that reason, the collection of contaminated soil began on August 23. Furthermore, soil was collected on the assumption that leaked contaminated water flowed into the area around the south side of the dike concerned where dosage of the drain valve installed in the dike concerned was high.

- a. In this undertaking, the extent of the contamination was first determined based on the results of a dosage investigation. The soil was then collected from the area concerned, placed in the square-shaped tanks, and stored on the eastern edge of the cesium adsorption tower interim storage apparatus (apparatus No. 2). Also, the dose was checked at the time of each excavation. In principle, excavation was performed so long as 70 µm dose equivalent rate (beta radiation) was less than 0.01 mSv/h. Furthermore, to prevent the inflow of rainwater, a steel plate was installed in the upper part of the square-shaped tank. Also, countermeasures were undertaken to reduce exposure when passing through or doing work as well as to serve as reminders by clearly marking off the zone with rope around the square-shaped tanks and displaying the surface doses for each tank.
- b. In this regard, owing to the possibility of structural collapse due to excavations eroding the bearing power of the ground in certain areas such as those nearest to the foundations of the

tank area, excavations were suspended out of consideration for personal safety and equipment preservation before the 70  $\mu\text{m}$  dose equivalent rate (beta radiation) reached less than 0.01 mSv/h.

- c. Furthermore, owing to the presence of multiple interfering objects near the radio relay station soil was collected in the area where it was possible. However, in one area it was not possible to excavate until the 70  $\mu\text{m}$  dose equivalent rate (beta radiation) reached less than 0.01 mSv/h.
- d. The total volume of contaminated soil collected was 878 m<sup>3</sup>.

(Attachment—3, 4)

#### (5) Recovering of Contaminated Dirt Inside Drainage Ditches

Contamination was confirmed at the concrete wall of the side ditch (drainage ditch B) near the leaking tank, and for that reason sandbags were placed where drainage ditch systems B and C flow together (completed August 27) and drainage ditch system B around area H4 north was cleaned (completed September 11).

Regarding the dirt in the drainage ditches, after the water standing in the ditches was collected and taken away, the accumulated dirt was collected and weeding was performed in the area around the drainage ditches. The water and dirt recovered were transported to the steel-made square-shaped tank cluster and stored there.

(Attachment—3, 5)

#### 5-2. Enhanced Monitoring Around Tanks

Based on the event involving the leakage of RO concentrated water from the tank concerned, the following countermeasures were enacted to prevent spread of the leakage and confirm the impact of the event concerned.

##### (1) Measures to Prevent Leaks from Expanding Outside Dikes

To prevent water standing inside the dike from leaking outside the dike, drain valves (three locations) that were shut immediately after the event occurred as well as all of the drain valves (21 locations) similarly installed in the dike concerned were closed on August 19. Also, as a countermeasure thought necessary in light of the event concerned the drain valves in all areas (RO concentrated water, RO processed water, ALPS-processed water) where tanks are installed were closed on August 28.

Furthermore, after the drain valves were closed the rainwater standing inside the dikes was put to the following uses.

- a. The rainwater standing inside the dikes will be drawn up into a temporary tank and drained out provided it satisfies the provisional effluent standards. Water standing inside the dikes that does not satisfy the provisional effluent standards will be collected in tanks.
- b. As a provisional use until December 2013, in the event that a rapid response is called for the water standing inside the dike is directly sampled and analyzed from four or more locations. Provided the results of the measurements (previous [immediate record] and current) satisfy the provisional effluent standard, the water will be directly drained out from inside the dike by opening the drain valve or using the drainage pump.

Furthermore, starting on May 21, 2014, sprinkler processing was begun on the processing station for those waters that, after radioactive nuclides had been processed with stormwater treatment equipment, were below the 0.22 notification level of concentration as set in the "regulations concerning the operational safety and the protection of specified nuclear fuel material at the TEPCO's Fukushima Daiichi NPS nuclear reactor facilities."

(Attachment—6)

##### (2) Enhanced Monitoring Around Tanks

- a. To quickly grasp changes in the tank leakage situation, the frequency and number of people performing on-site checks of the situation around the tanks that had been performed at a frequency of twice daily (two times by two people) were increased starting September 2 and as of September 21 were beefed up to four times per day (four times by 30 people, with the 30 people broken up into 3 persons for each of 10 areas).
- b. To date only visual checks mainly to observe leakage had been done, but to confirm the

situation at individual tanks the decision was made to additionally measure doses and water levels. Furthermore, in regard to confirmation of water levels as a measure until water gauges are installed in each of the flange-type tanks water levels have been checked regularly from the outside using thermal cameras. Also, water level trends were observed by remote in the case of tanks with water gauges installed.

- c. As methods for improving patrolling and monitoring methods, with regard to individual tanks the methods for inspecting and recording the presence or absence of leaks and suspicious standing water were reexamined to definitely include the bottoms alongside the sides. Also, changes were made to record keeping to make it possible to grasp changes in the situation due to leakage by also recording for each area and each tank the daily standing water, normal doses, and the like in addition to the presence or absence of anomalies in the facilities. What's more, in this regard along with providing education and training needed for workers conducting patrols the procedure manuals for patrol methods were updated to reflect the details of the revisions made.

(Attachment—7)

### (3) Assessing Contamination Situation

To investigate what kind of impact the leaked contaminated water had on the groundwater, drainage ditches, and ocean, in addition to sampling of existing groundwater bypass wells and survey tunnels new boring was done to perform ongoing measurements of the density of radioactive materials in the groundwater and analyses of the density of radioactive materials in the drainage ditch and sea waters are being continually performed.

(Attachment—8)

### 5-3. Results of Spot Inspections on Similar Tanks and Risk Reduction Strategies

In consideration of the facts that the radiation dose inside the tank concerned is high and that there is the possibility that time will be need for determining the leakage location and conducting a root cause investigation, external spot checks and ambient dose equivalent rate measurements were taken on August 22 of the tanks concerned used on the power station grounds, of similar all-bolt sealed-type tanks (305<sup>\*3</sup>), and of the dikes installed around those tanks (hereinafter, "outer dikes").

The results of the external spot checks did not show any anomalies such as leaks or standing water with respect to all of the similar tanks and outer dikes. However, ambient dose equivalent rate measurement results showed near the flanged sections on the bottom of area H3 cluster A RO concentrated water reservoir No. 10 tank dose rates of approximately 69.5 mSv/h (70µm dose equivalent rate [beta radiation]), and dose rates of approximately 99.5 mSv/h (70µm dose equivalent rate [beta radiation]) near the flanged sections on the bottom of area H3 cluster B RO concentrated water reservoir No. 4 tank.

Regarding the two aforementioned tanks, given that when the water level was measured a drop in water level compared with when the RO concentrated water was received could not be confirmed, it was determined that there was no possibility of leakage in both tanks.

Furthermore, from the perspective of reducing the leakage risk of the RO concentrated water standing in the tank, the transfer of water to the waste RO supply tank from area H3 cluster A RO concentrated water reservoir No. 10 tank was completed on September 11, 2013, and from area H3 cluster B RO concentrated water reservoir No. 4 tank was completed on January 31, 2014.

(Attachment—9, 10)

### 5-4. Results of Usage Investigation and Risk Reduction Strategies

During usage investigations of the tanks concerned, it was originally thought that the tanks concerned were tanks nos. 3, 4, and 8 installed in area H1 east. However, owing to the fact that the foundation parts around the tanks subsided in part during the water spreading trials conducted after the tanks were installed, they were dismantled in early August 2011 and the three tanks were planned to be moved to area H2 thereafter. Thereupon, in fact, it was decided that they, including the tank concerned, would be transferred to area H4 north (the two other tanks

---

3 The flange-type tanks were generally classified into types 1 through 5 based on the baseplate waterproofing construction. Of the 305 tanks installed, 120 were type 1, 20 were type 1', 37, were type 2, 59 were type 3, 59 were type 4, and 69 were type 5. Also, the tank concerned is Type-1.



being area H4 north cluster I RO concentrated water reservoir No. 10 and area H4 north cluster II RO concentrated water reservoir No. 3).

Furthermore, after they were moved to area H4 north, a water spreading trial was conducted in October 2011 and no anomalies such as leakages were discovered with the three tanks.

Regarding the tank concerned and the two tanks went through similar circumstances, a water transferred was conducted from the perspective of reducing the risk of leakage of RO concentrated water standing in the tank. Regarding the RO concentrated water in the area H4 north cluster II RO concentrated water reservoir, the plan was to complete the transfer of as much water as could be taken in by the RO concentrated water reservoir (No. 10 tank) installed in area H4 north cluster B, and for the transfer of the remaining water to occur together with the draining from the flange-model tanks planned for the current fiscal year. (the transfer was completed August 27 with regard to area H4 north cluster I RO concentrated water reservoir No. 10 tank)

(Attachment—11)

## 6. Environmental Impact Investigation Results (Spread of Contaminated Water)

The results of assessing the amount of leakage from tanks, and from investigating the impact of leaked contaminated water on the groundwater, drainage ditches, and ocean are presented below.

### 6-1. Assessing Amount of Water Leaked from Tanks

- (1) Five RO concentrated water reservoirs in the area H4 north cluster I is connected using linked ductwork. When RO concentrated water is to be received, the valve on the linked ductwork is opened in a way such that the level of the water in said five tanks remains uniform. After the water has been received, the valve on the linked ductwork is closed. After the event occurred, the top covers of the tank concerned as well as four other RO concentrated water reservoirs in the area H4 north cluster I were opened for the water level measurement. The water surfaces in the other four RO concentrated water reservoirs were at points around 0.5 to 0.6 m from the tank ceilings, while that in the tank concerned was approximately 3.4 m from the ceiling. Based on this, the tank water level was assessed as having fallen approximately 3 m. Since the tank concerned is one that can hold approximately 1,000 m<sup>3</sup> of water with a height of 10 m, when calculating based on water level it is thought that approximately 300 m<sup>3</sup> of RO concentrated water leaked out from the tank. As to the amount of this water that leaked outside the dikes, given that there was contaminated water collected within the dike concerned, and also that rainwater got mixed in and cannot be separated, the volume is estimated as having been approximately 300 m<sup>3</sup> at most.
- (2) Regarding the water levels in the tank cluster concerned, the results from having verified water level trends based on when withdrawal and receiving of RO concentrated water was performed at the end are confirmed as having been as follows. Furthermore, a single water gauge was installed in the fill and discharge tank (tank No. 7). When the filling and discharging of concentrated water took place, the connecting valves in the tank cluster were set to open.
  - a. It was assumed that the variation width in the rise of water level would get bigger when the connecting valve for the tank concerned suddenly closed as the water was being delivered. However, no such trend emerged and the water level rose at a constant rate.
  - b. In those cases from the start to the end of water delivery when the connecting valves were not sufficiently open (in a state of partial or only slight openness), the water level in the receiving tank was reduced slightly from July 20 to July 22 when water was not being received. However, no such trend emerge and the water level in the receiving tank changed at a constant rate.
- (3) The results of an investigation into the water level based on the traces of the draft line on the inner surface of the tank concerned were confirmed to be as follows.
  - a. Because traces of a draft line that went the entire way around the tank sides were confirmed at a position approximately 60 cm below the ceiling on the inside of the tank concerned, it is through that the tank concerned at least one time was in a full capacity state.
  - b. Furthermore, what appeared to be draft lines were also confirmed at lower positions of approximately 120 cm and 150 cm below the tank's ceiling. However, while the draft line from

when the tank was at full capacity was confirmed as going around the whole circumference, the draft lines from the lower positions were partial traces.

Based on the foregoing, the assessment is that it was in a full capacity state when it was being filled with RO concentrated water, the water level then gradually fell, and reached the water level it had when the leakage was discovered. On this based, the leakage volume was assessed at approximately 300 m<sup>3</sup>.

(Attachment—12)

- (4) As was indicated in section 4, the drain valve of the dike concerned was closed after the leakage was discovered. The concentration of radioactive materials in the leaked contaminated water standing inside the dike concerned was measured on August 19, and that of the tank water remaining in the tank concerned on August 23. The results showed a difference of around 50% in gross beta radiation, and the results were almost the same for the other nuclides. Given that the concentration of gamma ray-emitting nuclides and H-3 was almost the same, the leaked contaminated water standing inside the dike concerned is thought to be almost the same as the water in the tank concerned.

Also, the results of a Sr-90 analysis on the water in the tank concerned showed it to be  $1.5 \times 10^5$  Bq/cm<sup>3</sup>, roughly half that of the gross beta radiation concentration.

The leaked volume of 300 m<sup>3</sup> was multiplied against these radioactive material concentrations to obtain the leaked amounts. Calculating the volume of Sr-90—which is thought to have been of the highest concentration and would have the greatest impact on the environment—that leaked based on the result of the analysis of the tank water shows the amount to have been  $4.5 \times 10^{13}$  Bq.

(Attachment—13)

## 6-2. Results of Investigation on Groundwater Impact

### 6-2-1. Investigation of Radiation Dose on Ground Surface

- (1) The dose rates of the surface of the ground around the tank area concerned were measured. Measurements were taken at 91 points. The results showed that from the north side to the east side of the leaking tank concerned there were 12 confirmed points where the 70  $\mu$ m dose equivalent rate (beta radiation) exceeded 1 mSv/h. These high dose rate points were confirmed at locations of standing water around the dike concerned, points on the ground on the east side of the radio relay station to the northeast of the tank concerned, and also on the wall of adjacent drainage ditch B.
- (2) The contaminated water that leaked from the tank concerned is thought to have flowed out from the drain valve installed at the dike concerned and seeped into the soil around the dike concerned as it flowed toward drainage ditch B. Furthermore, it is thought to have flowed toward drainage ditch B with the remaining contamination on the surface of the ground having been washed along owing to rainfall at those places where leaked contaminated water seeped in. Furthermore, owing to the topography of the area being such that water easily stands in place, the fact that the dose rate rose just before drainage ditch B is thought to have an effect wherein the leaked contaminated water stood and seeped into the soil just before said ditch.

(Attachment—3)

### 6-2-2. Soil Contamination Condition Investigations Through Hole Boring

To grasp the contamination situation of the soil caused by leaked contaminated water, a boring core investigation was conducted through the observation holes as shown below.

- (1) Shallow boring
- Boring to a depth of 2 m was performed at 6 locations in the area where dose rates on the ground's surface were high. The results of the soil analysis performed detected gross beta radiation in high concentrations at locations C-1, -2, -3, and -4 on the northeast side of the tank concerned. Gross beta radiation was detected in high concentrations to a depth of 2 m in particular at locations C-1, C-2, and C-4 near standing water around the dike concerned.
  - On the other hand, while radioactive materials were also detected at locations C-5 and C-6 on the southwest side of the dike concerned, there were no great differences between gross beta

radiation concentration and the concentrations of Cs-134 and Cs-137. If the leaked contaminated water did have an impact, the gross beta radiation concentration would be expected to be greater by several digits than the concentrations of Cs-134 and Cs-137. However, there were no great differences in concentrations, and the gross beta radiation detected is thought to have come from the Cs-134 and -137 that adhered near the ground surface after the accident.

(Attachment—14)

(2) Boring directly under leaking tanks

- a. To confirm the contamination situation directly under the tank with leakage, boring to a depth of 2 m was conducted at 2 locations (material sampling performed September 12 and 13). Dose rates were measured at each depth of the boring cores. The results showed doses of 0.02 mSv/h or more in the 70  $\mu$ m dose equivalent rate (beta radiation) detected up to a depth of 1 m at location D-2 on the northeast side. A nuclide analysis was conducted on part of the boring core. The results showed gross beta radiation was detected up to depths of 0.2 m at a maximum of  $2.0 \times 10^7$  Bq/kg. Cs-134 and Cs-137 were also detected at concentrations on the order of tens of thousands of Bq/kg. However, since the concentrations were almost uniform in depth-direction, it is thought that the Cs-134 and Cs-137 that adhered neared the ground surface after the accident had been stirred up by the ground improvements done when installing the tank area.
- b. On the other, while radiation exceeding background levels was not detected from D-1 on the southwest side, given that there were no great differences in the gross beta radiation concentration and the concentrations of Cs-134 and Cs-137, it is thought that the contaminated water that leaked had hardly any effect.
- c. Also, no traces of leaked contaminated water penetrating concrete in the tank area and seeping underground were detected. The contaminated water that flowed out from the drain valve to outside the dike on the northeast side is thought to have gone around the crushed stone bed under the concrete foundation when it seeps underground and reached as far as near D-2 on the northeast side of the tank concerned.

(Attachment—14)

(3) Deep boring

- a. Of the 8 locations (E-1 through E-8) where boring was done to depths of 7 to 25 m for the purpose of measuring radioactive material concentrations in the groundwater, dose rates were measured at each depth in the boring cores at 5 locations near to the tank concerned. The results showed the 70  $\mu$ m dose equivalent rate (beta radiation) was 0.01 mSv/h or more at depths from 2.5 m to 4 m in boring core E-1 on the northeast side (geologically, the soil there had already been replaced to a depth of 2 m and it was difficult to pass water through up to around 2-2.5 m).
- b. Radiation exceeding background levels was not detected from neither E-2 on the southwest side nor E-3 nor E-4 on the east side. The gamma and beta radiation that were detected at E-4 was limited to near the ground surface, with gamma higher than beta. This is thought to be the effects of Cs-134 and Cs-137 that adhered near the ground surface after the accident. As the foregoing suggests, the leaked contaminated water is thought to have not had any impact on the sections of E-2 on the south side of the tank concerned and the sections of E-3 through 5 on the east side of drainage ditch B.
- c. Also, parts of the boring cores were sampled at E-1 and E-2 and a nuclide analysis conducted, with gross beta radiation of  $5.7 \times 10^6$  Bq/kg maximum detected near a depth of 3 m at E-1. Hardly any Cs-134 or Cs-137 was detected, which is thought to have an effect caused by the leaked contaminated water. The dose rate measurements at E-2 were similar, with Cs-134, Cs-137, and gross beta radiation all at low concentrations.
- d. Furthermore, in order to monitor the spread of leaked contaminated water by way of groundwater, additional boring was conducted at two locations: E-9 on the east side near to the radio relay station where leaked contaminated water is thought to have flowed into drainage ditch B, and E-10 on the east side of the tank concerned. Dose rate measurements were taken and nuclide analysis performed on the boring core. Gross beta radiation in high concentrations was detected at E-9 near to 2 m from the ground surface. On the other hand,

while contamination mainly from beta rays and gross beta radiation was detected near the ground surface, it was almost the same as the concentrations of Cs-134 and Cs-137.

Based on the foregoing, while effects were confirmed underground at E-1 and E-9 near the tank concerned that are thought to be due to the Sr-90 in the leaked contaminated water, effects from contaminated water could not be confirmed at locations E-2 through 5 and E-10 a slight distance away.

(Attachment—14)

### 6-2-3. Groundwater Quality Analysis

Since leakage from the tank concerned was confirmed, boring was performed at 10 locations in all (E-1 through E-10) and the water quality monitored with the objective of measuring the radioactivity density of the groundwater. The results of the investigations so far are as shown below.

- (1) The effects of Sr-90 in the leaked groundwater were monitored based on gross beta radiation concentration. At observation hole E-1 near the dike concerned on the northeast side of the tank concerned, gross beta radiation in high concentrations was detected even after contaminated soil from the perimeter had been collected. A well-point for drawing up contaminated groundwater was installed at the perimeter of observation hole E1 and drawing up took place. The phenomenon then occurred where the gross beta radiation concentration in the groundwater at observation hole E-1 was on a downward trend, but when there was rainfall the concentrations once again rose. It was understood from the results of the boring core investigations that the effects of leaked contaminated water were extending to the soil below the concrete foundation of the tank area concerned. It was thought that this Sr-90 in the soil that could not have been collected was flowing into the area near observation hole E-1 hand in hand with the rainwater and the rise in the groundwater level. Gross beta radiation concentration suddenly rose on October 17, but this was thought to be the effect of Sr-90 in the surrounding soil flowing into the area near observation hole E-1 due also to rainfall the previous day.
- (2) Also, gross beta concentration radiation rapidly rose from February onward at E-9 on the east side of the area near the radio relay station. Some contaminated soil that could not be collected due to obstacles in the ground remains around E-9, and it is thought that Sr-90 in the soil flowed in together with rainwater owing the impact of precipitation in February. There were instances at other observation holes where the gross beta radiation concentration was detected in water samples immediately after excavation at levels ranging from several hundred to several thousand Bq/L, but the radioactive density fell thereafter. At present, it is thought that there is hardly any effect from Sr-90 from the drainage ditch to the east side.
- (3) With regard to H-3, gross beta radiation was similarly high at E-1 and E-9, with a high concentration also at E-10. Furthermore, it was also detected on the order of several thousands of Bq/L at E-3, E-4, and E-5 on the east side of drainage ditch B. Since at H-3 it is the water itself and there is no adsorption into the soil, it is thought that it was spread up to the east side of drainage ditch B together with the groundwater. Aside from this, no rise in concentration has been seen at the present time at observation hole E-6, which is comparatively far from the tank concerned. H-3 was detected initially at a level of 1,000 Bq/L at E-7 and E-8, but thereafter the levels went from being stable to going on a downward trend. To what degree the event concerned had an effect is not clearly understood.
- (4) Furthermore, to grasp the effects produced by past leakages in the neighborhood of the tank area concerned, boring (F-1) was performed on the west side of the tank area and a radiation analysis conducted on the ground water. Gross beta radiation concentration stood around 20 Bq/L and H-3 concentration at several hundreds of Bq/L, results that do not differ from those of analyses performed at groundwater pump wells monitored since prior to the leakage. Still further, monitoring was begun of radioactive material concentrations at the preexisting boring holes on the east side of the tank area concerned (groundwater bypass pump wells nos. 5 through 12, and investigation holes b and c), but no gross beta was detected. With regard to H-3 concentrations, it has risen at most as far as 2,000 Bq/L at pump well No. 12 on the south side, but this is some distance from the northeast side where contaminated water from area H4 north

has leaked. The degree to which the event concerned affected this is not clearly understood. As to the other pump wells and investigation holes, the H-3 concentrations have been on the order of several hundreds of Bq/L. Those results do not differ from those of analyses performed at groundwater pump wells monitored since prior to the leakage.

(Attachment—15, 16)

#### 6-2-4. Assessing Amount of Radioactive Materials Collected

Because the leaked contaminated water has mainly seeped into the soil, it is thought that most of the Sr-90 was absorbed into the soil around the dike concerned and part of it mixed into the groundwater. It is also thought that aside from being included in the soil in liquid form, most of the H-3 was mixed into the groundwater. In order to evaluate the environmental impact, an estimate was made as follows of the amount of Sr-90 recovered from soil collection using the gross beta radiation concentration as an index.

##### (1) Relationship between soil surface dose rates and nuclide concentration

The relationship between the 70  $\mu\text{m}$  dose equivalent rate (beta radiation) and gross beta radiation concentration in the boring cores investigated as shown in section 6-2-2 (3) was found on the whole to be  $3.0 \times 10^7$  ((Bq/kg)/(mSv/h)). Using that relationship, it was possible to estimate the gross beta radiation concentration in the collected soil based on the 70  $\mu\text{m}$  dose equivalent rate (beta radiation) of the soil.

##### (2) Estimates of amounts collected

The collected soil was excavated in principle when the surface dose rate of the soil fell below 0.01 mSv/h. Using the measurement data from that time, the gross beta radiation concentration of the collected soil was estimated for each block and depth. Multiplying that by the volume of soil collected produced an estimate of the amount of beta nuclides collected of  $7.4 \times 10^{13}$  Bq. Also, it is thought that the analysis of gross beta radiation in the collected soil shows that several months after the collection the Sr-90 and its daughter nuclide Y-90 are in a condition of equilibrium. Assuming on this basis that half the amount is Sr-90, the recovery rate obtained is approximately 80% based on the quantity of leaked radioactive materials obtained (Sr-90:  $4.5 \times 10^{13}$  Bq) as shown in 6-1 (4).

Given that hardly any rise of gross beta radiation concentration could be seen in the groundwater at observation holes outside area H4 north, it is thought that most of the Sr-90 that could not be recovered had accumulated in the soil within area H4 north in difficult-to-collect locations such as under the tank area foundation and under equipment around the radio relay station.

Furthermore, some leaked contaminated water was recovered in the water drawn up from drainage ditch B and at the wellpoint. However, because the amount of radioactivity collected was two to three digits lower, it was not something that had an effect on the evaluation results of the amounts collected from the soil.

(Attachment—17)

#### 6-3. Results of Investigation into Impact on Drainage Ditches

(1) The contaminated water that leaked from the tank concerned is thought to have flowed in the direction of drainage ditch B as indicated in 6-2-1 (2). However, beta radiation in high concentrations was confirmed on the walls of drainage ditch B in the neighborhood of the tank area concerned, and part of the leaked contaminated water is presumed to have flowed from this highly radioactive location into drainage ditch B. That said, when the leakage was discovered the leaked contaminated water was not flowing on the surface of the ground, and no flow into drainage ditch B was confirmed.

(2) After the leakage was discovered, water samples were taken from drainage ditch B in the neighborhood of the tank area concerned, drainage ditch C downstream, and from the point where drainage ditches B and C merge. A radiation analysis was conducted on the samples. Given that the gross beta radiation concentration of drainage ditch B was on the order of several Bq/L, drainage ditch B was dammed up with sandbags. It was then cleaned and ducting performed that included drainage ditch C. Gross beta radiation more than 100 Bq/L had been

detected immediately after the leak at the 30 m board outlet (C-2) of drainage ditch C downstream. However, after the cleaning of drainage ditch B and the completion of ducting (with water allowed to flow through again starting March 2014), the amount had dropped to 20 Bq/L. Furthermore, at present there are instances when it rains where the concentration rises to 100 Bq/L at the 30 m board outlet (C-2) of drainage ditch C, and gross beta radiation is also being detected when it rains upstream (B-0-1, C-0) of the tank cluster where RO concentrated water is being stored. Based on this situation, at present the event concerned has not been confirmed as having had an effect. Decontamination and facing of the entire grounds is continuing in the effort to improve the environment.

(Attachment—18)

#### 6-4. Results of Investigations into Impact on Ocean

Based on a dose rate investigation of the surface of the ground and an investigation of the drainage ditches, it was thought that some of the leaked contaminated water had flowed into the drainage ditches. For that reason, drainage ditch B was dammed up with sandbags and the water and dirt that had accumulate in the drainage ditch was collected.

Furthermore, drainage ditch B was cleaned and ducting performed that included drainage ditch C. Water was allowed to flow through again in March 2014.

No significant increases in the results of gross beta radiation measurements have been noticed in either the seawater monitoring that has been continuously performed at north and south wash ports since before the leakage was discovered or the monitoring of seawater around the harbor that began August 14.

(Attachment—19)

#### 7. Root Causes Investigation Content and Results

The following investigation took place to identify the location of the leakage from the tank concerned and root cause of the leakage. The investigation was performed on those sites presumed from the construction of the tank concerned to be the locations of leaks, and categorized into inspections prior to, during, and after dismantling. The subjects of the investigation were the base material (welded sections) and flanged sections in the sideplate and baseplate, along with the linked ductwork and adjacent valves connecting it to the other tanks.

#### 7-1. Results of Investigation into Locations of Tank Leaks (pre-dismantling)

##### (1) Side Plates

##### a. Base material (welded sections)

##### ① Visual check of outer surface

A visual check of the outer surface of the sideplate conducted prior to draining the water retained in the tank did not confirm any significant leakage.

##### ② Dosage measurement of outer surface

A dosage measurement of the outer surface of the sideplate was performed since it was thought that the leakage traces would show large amounts of beta radiation in the event that RO concentrated water in the tank containing large amounts of beta radiation had leaked. The measurements confirmed one location with a relatively high dose rate (approx. 40 mSv/h [70  $\mu$ m dose equivalent rate (beta radiation)]) near where the first layer of sideplate and the circumferential flanged material are welded together (a localized rust outbreak was also confirmed).

No other highly radioactive locations of the sort that would indicate leakage were confirmed.

##### ③ Localized vacuum tests on sideplate outer surfaces

As a precautionary measure, localized vacuum tests were performed from the outside of the tank at the location on the sideplate outer surface where the relatively high dose rate was confirmed (location of rust outbreak). The test results did not show the continuous formation of bubbles from the bubble solution applied to the section concerned, nor was there any suction on the mousse applied near the welded sections on the inner surface of the tank hypothesized to be path of the leakage. It was not confirmed to be a leakage path.

##### ④ Visual checks of inner surfaces

A visual check was performed from inside the tank of the inner surface of the side walls. A

discolored section thought to be an outbreak of rust was confirmed at one part near the welded section between the first layer of sideplate and the vertical flanged material. The surface encrustation confirmed of the discolored section thought to be rust was easily peeled off, and for the most part the coating remained on the inner surface of the tank after peeling off the encrustation.

b. Flanged sections

① Visual check of outer surface

A visual check was performed just like that in section "(1) Sideplate, a. Base material (welded section), ① Visual check of outer surface," the results of which did not confirm any significant leakage.

② Dosage measurement of outer surface

A dosage measurement was taken just like that in section "(1) Sideplate, a. Base material (welded section), ② Dosage measurement of outer surface," the results of which did not confirm any highly radioactive locations of the sort that would indicate leakage.

③ Visual checks of inner surfaces

A visual check was performed just like that in section "(1) Sideplate, a. Base material (welded section), ④ Visual checks of inner surfaces," the results of which confirmed the partial deformation and peeling of sealing materials on the inner surface of the flanged section (circumferentially and vertically) and packing jutting out.

④ Dosage measurement of inner surface

The results of the dosage measurement taken from inside the tank showed the dose on the inner surface of the flanged section (circumferentially and vertically) to be 10 mSv/h (70  $\mu$ m dose equivalent rate [beta radiation]) on the whole and up to 20 mSv/h (70  $\mu$ m dose equivalent rate [beta radiation]) at most. No sections with conspicuously high dose rates were confirmed.

(2) Baseplates

a. Base material (welded sections)

① Baseplate bubbling test

With lowest possible amount of water spread out inside the tank, the bottom part of the baseplate (the gap between the baseplate and concrete foundation) was compressed using air and then a bubbling test performed on the baseplate to confirm whether or not air bubbles would form in the tank. The test results did not show the formation of air bubbles inside the tank, and it was not confirmed to be a leakage path.

② Baseplate bottom part vacuum test

After the tank was drained of water, the bottom part of the baseplate (the gap between the baseplate and concrete foundation) was suctioned from outside the tank using a vacuum pump and a vacuum test of the baseplate bottom part performed to confirm whether or not the mousse applied inside the tank would be drawn out. The test results did not show bubbles being suctioned in to the welded sections attaching the baseplate flanges, and it was not confirmed to be a leakage path.

b. Flanged sections

① Baseplate bubbling test

A test was performed just like that in section "(2) Baseplate, a. Base material (welded section), ① Baseplate bubbling test," the results of which did not confirm any bubbles being formed.

② Visual checks of inner surfaces

A visual check performed from inside the tank partially confirmed a bulge in the sealing material of the flanged section.

③ Bolt tapping test

The results of bolt tapping tests performed on the baseplate flanged section confirmed some (5) of the bolts were loose.

④ Dosage measurement of inner surface

The results of the dosage measurement taken from inside the tank showed the dose on

the inner surface of the baseplate flanged section to be 10 mSv/h (70  $\mu$ m dose equivalent rate [beta radiation]) on the whole and up to 22 mSv/h (70  $\mu$ m dose equivalent rate [beta radiation]) at most. No sections with conspicuously high dose rates were confirmed.

⑤ Baseplate bottom part vacuum test

A test was performed just like that in section "(2) Baseplate, a. Base material (welded section), ② Baseplate bottom part vacuum test," the results of which confirmed the drawing in of bubbles (meaning a perforated section thought to be a path of leakage was present) from 2 of the bolts (not bolts confirmed with the bolt tapping test to be loose) adjoining it to the baseplate flanged section.

⑥ Baseplate localized vacuum test

A localized vacuum test was performed from inside the tank at the location where the drawing in of bubbles was confirmed by the baseplate bottom part vacuum test. The results of the test confirmed that bubbles formed (meaning a perforated section thought to be a path of leakage was present) at the bolt area concerned from the bubbling solution applied to the section concerned.

Furthermore, as a precautionary measure, the test was also performed the bolts (5) where looseness was confirmed and on representative sections where bulging in sealing materials was confirmed, but the formation of bubbles was not confirmed.

(3) Linked Ductwork and Adjacent Valves

a. Visual check of external appearance

Before draining water, a visual check of the external appearance was performed on the linked ductwork connecting the tank concerned with adjacent tanks and on the valve adjacent to the tank concerned installed at the linked ductwork. The results did not confirm any significant leakage.

b. Dosage measurement

Dosage measurements taken of the linked ductwork and adjacent valve did not confirm any highly radioactive locations of the sort that would indicate leakage.

(Attachment—20)

7-2. Results of Investigation into Locations of Tank Leaks (during dismantling)

(1) Side Plates

a. Flanged section

① Bolt torque measurements

Torque measurements were taken of the bolts on the vertical flange of the first layer of baseplate and on the circumferential flange that connects it to the baseplate. The measurement results on average show the torque value for the vertical flange to be approximately 390 N·m and that of the circumferential flange to be approximately 450 N·m. Those values appear to have dropped (vertical 950 N·m, circumferential 600 N·m) from when the bolts were attached. Also, a comparison with the baseplate flanges (further details below) showed the torque values tended to be high. Furthermore, the bolts on the sideplate flanges were installed in the outer surface of the tank. After the tank was installed, they were retorqued two times.

(2) Baseplates

a. Flanged section

① Measurement of separation and differences in level between flanges

After the sealing material on the baseplate flanged section was removed, the amount of separation and differences of level between the flanges was measured. To measure the separation, the flanging width was measured including the flanges (design width of 25 mm x 2). The results showed the width of the flanging on the line of the bolt sections (2) thought to be the location of a path of leakage was roughly 50 mm. A comparison with the width of the baseplate flanging on other lines showed the figure to be somewhat small. Furthermore, the flanging width on both sides of the bolt sections (2) thought to be the location of a path of leakage were 49.9 mm and 50.9 mm, respectively. No striking discrepancies with the flanging widths at other locations on the same line were confirmed.

The results of level difference measurements of the flanges found the difference measured to



be 4 mm at most. No difference was apparent at the bolt sections (2) thought to be the location of a path of leakage.

② Bolt torque measurements

The torque measurement results for the bolts in the baseplate flanged section showed confirmed torque values to be 202 N·m on average. On the whole, the torque values appear to have dropped (950 N·m) from when the bolts were attached. Furthermore, the torque values for the bolt sections (2) thought to be the location of a path of leakage were 100 N·m and 240 N·m. No conspicuous decline compared to other bolts was apparent.

③ Baseplate bottom part vacuum test

After the sealing material on the baseplate flanged section was removed, a vacuum test was once again performed on the baseplate bottom part. The results did not confirm the drawing in of mousse from the upper surface of the flange after the sealing material was removed.

Also, the 2 bolts in the section thought to be the location of a path of leakage were removed and a baseplate bottom part vacuum test was performed in the same way. The drawing in of bubbles was confirmed on the bottom side of the flanged surface at both bolt holes concerned.

④ Measurement of gaps and visual check of bolt sections thought to be leakage path location

Before removing the bolts, gap measurements were taken at the bolt sections (2) thought to be the location of a path of leakage. Gaps were confirmed at the two bolts between the flanges and the washers, and between the washers and the bolts. The gaps were on the order of 0.23 mm at maximum.

Also, a visual check of the insides of the bolt holes was performed after the 2 bolts concerned were removed. The opening of the bolt hole that was the closer of the adjoining pair to the manhole had a width of approximately 3 mm and length of approximately 22 mm, while that of the other had a width of approximately 2 mm and a length of approximately 11 mm. Furthermore, the openings concerned were the location where the bubbles were drawn in during the baseplate bottom part vacuum test.

(Attachment—21)

### 7-3. Results of Investigation into Locations of Tank Leaks (after dismantling)

#### (1) Side Plates

##### a. Flanged section

① Visual check by applying liquid penetrant

During (immediately before) dismantling of the tank a liquid penetrant was applied to the inner surface of the flanged section on the first of layer of the tank's sideplate. A visual check was then performed on the flange surface after the tank was dismantled. The results of the visual check of the flanged surface did not confirm any sections that would indicate leakage such as through the seeping of liquid penetrant.

#### (2) Baseplates

##### a. Flanged section

① Visual check by applying liquid penetrant

Immediately before dismantling, liquid penetrant was applied to the flanged sections and bolt sections on the inner surface of the tank. After the tank was dismantled, a visual check of the flanged surfaces was performed. Other than section already confirmed to be a leakage path and the bolt sections (2) thought to be such, the results of the visual check of the flanged surface did not confirm any sections that would indicate leakage such through the seeping of liquid penetrant.

② Detailed visual check of bolt sections thought to be path of leakage

A detailed visual inspection was performed after the tank was dismantled on the surfaces of the flanges near the bolt sections (2) thought to be a path of leakage. The results of the check showed the packing contact area of the section concerned to be considerably askew, and traces were confirmed of the upper end of the packing had jugged down even farther than the bottom end of the flange surface (the appearance of a leakage path having formed).

Also, a rust outbreak was confirmed on the flange surface between the packing contact trace

and filler on the flange surface at the location concerned where the packing was jutting out.

③ Measuring openings at flanges

The gaps (of the bottom end with respect to the top end) in the baseplate flanges were measured after the tank was dismantled. The results confirmed an opening on the bottom side of the flanges at the locations (2 bolts) thought to be a path of leakage and the flanged sections on the line concerned. However, the amount was trifling (1 to 2 mm) compared to the separation between the top and bottom ends (approximately 116 mm).

④ External appearance check of removed bolts

The external appearances were checked and dimensions measured of the removed bolts after the tank was dismantled, the results of which did not confirm any anomalies such as significant deformations in the 2 bolts from the locations thought to be a path of leakage.

⑤ Results of visual check of flange surfaces

After the tank was dismantled, a visual check of the flange surfaces was performed. Based on the condition of the flange surfaces, other than at the section concerned no situation was confirmed where the packing seemed to be dropping out from the bottom part of the flange surface (a rust outbreak spreading from the bolt section to the bottom part of the flange surface).

(3) Concrete Foundation

After the tank was dismantled, measurements were performed of the elevation differences in the concrete foundation with respect to the area where the tank had been installed. The results of those measurements showed that, using the highest location as a point of reference, there was an elevation of difference on the order of 3 cm at most. The locations (2 bolts) thought to be a path of leakage were about 2 cm lower than the recommended point, but no tendency for it to be conspicuously low compared to its surroundings was apparent.

(Attachment—21)

7-4. Some Considerations Regarding the Investigation Results

(1) Determining the Locations of Leaks

a. Sideplate base material (welded sections)

There were regions where a localized rust outbreak and comparatively high radiation doses were confirmed near some of the welded sections on the sideplate outer surface. However, paths of leakage were not confirmed in the localized vacuum test on the sideplate outer surface. Also, no significant leakage was confirmed at other regions in the visual external appearance check when RO concentrated water was being held, nor were any locations indicating leakage seen in the outer surface dosage check. For these reasons, it is thought that sideplate base material (welded sections) is not a region of leakage.

Furthermore, while a discolored section thought to be a rust outbreak was confirmed at some of the welded sections on the inner surface of the sideplate, the surface encrustation on the section concerned was easily peeled off. A blend of corrosive products and soil ingredients included in RO concentrated water are thought to have selectively adhered to the corroded section through static. With regard to the coating at the section concerned, an inspection of the welded sections concerned was conducted and several days later the work was done. It is possible that at this time the coated surface was not cleaned and the condition of the section concerned was relatively worse off than the surrounding areas of sideplate coating. It is thought this is why the corrosion occurred. Furthermore, the coating for the most remained on the inner surface of the tank after the encrustation was removed, and the degree of corrosion was slight. This is thought to have not been a matter that affected the waterproofing characteristics of the tank's inner surface.

b. Sideplate flange sections

Some deformation of the sealing material was apparent in the visual check of the inner surface of the sideplate flanged sections. However, no significant leakage was confirmed in a visual check of the outer surface when the tank was holding RO concentrated water, nor were any locations that would indicate leakage apparent from dosage check of the outer surface. For these reasons, it is thought that the sideplate flanged sections are not a region of leakage. Furthermore, the deformations in the sealing material are thought to have been caused by

swelling due to the absorption of water by the packing (expansible liquid stopping material) and retorquing of the flange bolts. Conditions that would indicate a leakage path were not confirmed even during the flange surface checks performed after dismantling. For these reasons, the reduction in waterproofing characteristics is not thought to have an effect, and accordingly it is not thought to have been a direct factor in the leakage event at hand.

c. Baseplate base material (welded sections)

Since neither the baseplate bubbling test nor the baseplate bottom part vacuum test could confirm any locations that would indicate a path of leakage, the baseplate base material (welded section) is not thought to have been a location of leakage.

d. Baseplate flange sections

Regarding the baseplate flange sections, the baseplate bubbling test could not confirm the formation of bubbles. However, in the baseplate lower part vacuum test mousse was suctioned in from two neighboring bolt sections, and the formation of bubbles using bubbling solution was also confirmed in the baseplate localized vacuum test. This confirmed that a path of leakage existed in the bolt section concerned. Furthermore, a detailed check of the flange surface done after the tank was dismantled confirmed that the upper end of the packing at the section concerned had broken through and was projecting from the bottom edge of the flange surface, forming a leakage path.

Regarding the leakage path, the baseplate vacuum test performed after the sealing material had been removed from the upper part of the flanged section concerned did not confirm the suctioning in of mousse from the upper part of the flange; gaps were confirmed among the flanges, washers, and bolts; an opening was confirmed in the flange surface in the bolt holes; and packing was confirmed as projecting from the flange surface when it was checked after the tank was dismantled. Based on this, it is thought that rather than leaking from the upper parts of the flanges concerned, RO concentrated water passed through the openings in the flange surface where the packing projected out via the bolt holes from the gaps among the flanges, washers, and bolts, and leaked to outside the tank.

Furthermore, with regard to the locations where deformations in sealing material were apparent in the visual check performed inside the tank, and to the locations where the tapping test confirmed looseness in the bolts, no suctioning in of mousse was confirmed in the baseplate bottom part vacuum test, nor was a situation confirmed with a visual check of the flange inner surface after the tank was dismantled that would indicate a path of leakage. For these reasons, they are not thought to be leakage locations. For that reason, deformation and looseness are thought to have not been direct factors in the leakage event at hand.

The results of the gap measurements at the bolts confirmed there were gaps among the flanges, washers, and bolts at the leakage locations noted above (2 bolts). However, the measurements of separation between flanges, level difference measurements, and gap measurements did not confirm any conspicuous differences between the leakage path locations and the other locations.

Also, regarding the fact that bubbles could not be confirmed as forming from the leakage path locations in the baseplate bubbling test, the space between the surface of the concrete foundation and the tank baseplate was compressed for purposes of the test. Given that this course of action acted on both the path and reverse path owing to the pressure of the water held in the tank, it is thought possible that behavior became one that sealed the opening at the leakage location.

e. Linked ductwork and adjacent valves

Regarding the linked ductwork and adjacent valves, no significant leakage was confirmed in the visual check of the section concerned performed before draining water, nor were any high dosage locations of the sort that would indicate leakage when dosage was checked. On that basis, neither the linked ductwork nor the adjacent valves are thought to have been regions of leakage.

Based on the foregoing, the RO concentrated water in the tank concerned is thought to have leaked from the location (2 bolts) where packing was confirmed as projecting from the flange

section of the tank baseplate.

## (2) Assumptions about Root Cause of Leakage

Based also on visual checks of the flange surface done after the baseplate was dismantled, the circumstances leading to leakage outbreak were assumed to be as follows.

- a. Given that a rust outbreak could be seen on the flange surface between the packing contact traces and the putty, the RO concentrated water is thought to have been in contact with the flange surface for a long period of time. The packing surface contact traces were even more askew than the swelling patterns in the remaining putty. For these reasons, the packing is assumed to have gradually fallen after the bolts were fastened when the tank was installed.
- b. Given that the packing was projecting down even farther than the bottom end of the flange surface, it is assumed that the packing had continued to drop (separate) and finally projected from the bottom of the tank, leading to the formation of a flow channel and the leakage outbreak.

With regard to the packing at the flange section of the tank baseplate having project from the flange bottom, the results of the investigations done before and after dismantling the tank were combined to see whether each hypothesized factor in the outbreak could have been a root cause of leakage. As a result of the check, gaps in the bottom end of the flange and drops in the torque of the fastener bolts were confirmed at the leakage location. It was also realized that there was the possibility a slight amount of swelling had occurred in the packing (bottom side) when the bolts were fastened. Given that individually these are not phenomena confirmed only at regions where leakage was confirmed, they are not thought to be direct root causes. However, because these factors were superimposed upon one another at leakage locations, they were assumed for the following reasons to have been root causes for the packing to have detached.

At the leakage location, slight swelling occurred in the packing when the bolts were fastened. The effects of the thermal expansion and contraction of the flanges caused a drop in the torque of the bolts that secured the packing, and the bottom end of the packing opened up. Owing to the superimposition of these factors, it is possible that the packing could not resist the tank water pressure, it separated downward, and in the end projected out from the tank bottom.

(Attachment—22)

## (3) Confirmed Leakage Volume and Comparative Verification of Leak Locations

- a. As indicated in 6-1 (1), the total volume of water that leaked from the tank concerned based on the approximately 3 m drop in water level is estimated at approximately 300 m<sup>3</sup>. Also, given that the drop in the water level as of August 20 had been approximately 5 cm over approximately 6 hours, the leakage rate is thought to have been approximately 5 m<sup>3</sup>/6h. Given that corrosion could also be seen on the leakage path during the visual check of the flange surface done in the present root cause investigation, it is thought possible that the corrosion of the flange surface advanced gradually and, at a certain point, the separation of the packing got bigger and the leakage rate grew.
- b. Regarding the path of leakage that produced the approximately 5 m<sup>3</sup>/6h rate, considering the water pressure concerned the area of the opening for the purposes of calculation would have to have been approximately 25 mm<sup>2</sup>. On the other hand, the area of the opening as calculated from the gap measurements made on part of the flanges, bolts, and washers in the leakage area was approximately 16 mm<sup>2</sup>. When one considers the facts that the leakage path was formed as a complex aperture run through with corroded sections, and that the water level measured in the tank when the leakage rate is computed was not measured with great precision and a 1 to 2 cm margin for error, the calculated value based on leakage rate and calculated value based on the gap measurement results are on the whole the same. The approximately 300 m<sup>3</sup> leakage is thus thought to have been produced from the opening concerned.

(Attachment—23)

#### (4) Time Leakages Occurred from Locations of Leaks

The results of studies of the time when the leakage from the tank concerned occurred are displayed below.

- a. Because no clearly noticeable leakage had been confirmed on patrols prior to August 19 when the leak was confirmed, the possibility that a large volume of water had been leaking for several days is low.
- b. The leakage rate at the time the event was discovered is thought to have been approximately 5 m<sup>3</sup>/6h as indicated in (3) above, or approximately 20 m<sup>3</sup> per day. Given that there was approximately 300 m<sup>3</sup> of leakage from the tank, it is possible that the tank had been leaking 15 days before August 19 when the leakage was discovered.

Furthermore, relatively high 70 µm dose equivalent rates (beta radiation) were confirmed from the tank area concerned to the east side of the radio relay station on the northeast side. Checking the external radiation doses due to beta radiation for workers on the tank patrol and working near the radio relay station with measured values using APDs revealed that while there was little change apparent prior to when the event occurred for workers on the tank patrol, the external radiation doses due to beta radiation that previously had not been confirmed when working near the radio relay station were confirmed in the last third of July. This indicates the possibility that the leakage began in mid-July.

(Attachment—24)

#### (5) Miscellaneous Other Items

##### a. Impact of tank relocation

As indicated in 5-4, the tank concerned had been relocated from area H1 east. Given that the root cause of the leak at hand is assumed to have been the separation of packing due to the effects over time of thermal expansion and contraction on the packing, the relocation of the tank is not thought to have been a direct cause. Furthermore, a water spreading trial conducted after the tank was relocated had confirmed there were no leakages.

##### b. Concrete foundation

A check of the concrete foundation performed after the tank was dismantled confirmed the presence of one minute crack (a trivial, closely-attached crack with a width of less than 0.03 mm and length of approximately 80 cm). However, no tendency had been apparent for the levels of rainwater standing near the tank concerned to be dropping. Boring at two locations directly under the tank concerned confirmed contamination only near the surface of the ground at a location (D-2) near the area of standing water confirmed outside the dike. No radial spreading that would foretell an outbreak when water seeped in from the tank bottom was apparent. For these reasons, this contamination is thought to have been the effect of leaked contaminated water that had gone around to outside the dike. Accordingly, it is assumed there was no seepage into the ground from the concrete foundation.

(Attachment—14, 25)

#### 8. Circumstances Related to Operations Management

After the leakage of approximately 300 m<sup>3</sup> from the tank to inside and outside the dike occurred, interviews were conducted with the people involved about the circumstance related to operations management at the contaminated tank. The results were analyzed and the following items confirmed.

##### (1) With Respect to Monitoring for Leakage at Contaminated Water Tanks

Heretofore, visual inspections of the contaminated water tanks were conducted by patrols twice daily. The standing water inside the dike at the tank area had been discovered by the patrol the day before, but given that previously it had been confirmed that some rainwater will remain standing and not wash away, it was not possible to distinguish between rainwater and leaked water. For this reason, dose rates and the like were not confirmed to see if there was the possibility that RO concentrated water had leaked from the tank. Furthermore, no early leak detection procedures such as the installation of water gauges in each tank were in place other than visual inspection by a patrol. Against this backdrop, it may be stated that there were not thought to be any problems with management of the contaminated water tanks because when

small leaks from the side flanges had occurred in the past it had been possible to stop leakages from the tanks by regularly retorquing the flanges. One could also consider that the number of patrol staff remained unchanged at 10 despite the fact that the number of tanks on site had been increased, and that they were not able to spend sufficient time on patrol from the perspective of reducing their radiation exposure.

(2) With Respect to Opening Operation during Regular Use of Drain Valves on Tank Dikes

The building of dikes in order to contain the expansion of leaks at contaminated water storage facilities was set down in the "Implementation Plan Regarding Specified Reactor Facilities: Fukushima Daiichi Nuclear Power Station." That said, in order to be able to quickly discover leakage from a tank when it occurs, the drain valves on the dike would be run at open to discharge rainwater during rainfalls and to dry out the ground at the area where the tanks were built. Against this backdrop, the judgment was that it would be possible to prevent leakage by closing the drain valves in the event that a slight leak from the tanks was confirmed, and also that it was hard to imagine that contaminated water could overflow from the tanks in large quantities. The thinking also went that the rain that fell inside the dike would have a radioactive density of the same level as the rainwater that flowed into the general purpose drainage ditches on the grounds of the power station. Due to the fact that it would stand briefly and because there were concerns about the pressure it would put on the capacity of the storage tanks if it had to be stored, the thinking ran that they did not want to accumulate rainwater inside the dikes.

Based on these factors, the drain valves on the dikes were operated with the on-site given priority.

(3) With Respect to Leakage Risk at Contaminated Water Tanks

Regarding the building of tanks for storing contaminated water, there was demand for them to be installed rapidly given that the continually rising amount of contaminated water had to be securely stored. For that reason, it was decided that flange-type tanks that could be put into operation after a short construction period would be built first and thereafter be systematically replaced with highly reliable welded tanks. However, this plan did not take concrete shape.

Also, with regard to contaminated water strategies to date, risk management was being handled at multiple in-house review committees. The possibility that slight leaks from flange-type tanks was shared among them. On the other hand, the risks related to the possibility of large volume leakage from flange-type tanks was not studied within in the company.

It may be stated that what resulted from this chain of circumstances is that there were many urgent jobs to be handled on-site such as responding to the outflow of contaminated water from the trenches into the harbor and expanding the number of tanks to store contaminated water that was increasing by 400 m<sup>3</sup> daily. It was also thought that the flange-type tanks could be used for about 5 years, and while slight leaks from side surface flanges had occurred in the past there were not thought to be any problems with contaminated tank management as noted above.

Based on the foregoing, when it came to operations management of the contaminated water tanks risk management at the tanks was a problem, not being able to recognize issues was a problem, and the biggest problem of all was not being able to thoroughly analyze current conditions.

## 9. Countermeasures

Based on the root cause analysis that has been conducted, countermeasures have been devised from facilities and operational perspectives to make possible a more thorough approach to risk management with respect to the contaminated water tanks.

Based on the mechanism by which the leakage occurred, the following countermeasures will be implemented from a facilities perspective. The goal is to prevent it from recurring and to prevent its impact from expanding in the unlikely event of a leak. Also, countermeasures from an operational perspective will be implemented based on the results of confirming the circumstances involved. Furthermore, measures have been put together as emergency safety countermeasures for Fukushima Daiichi Nuclear Power Station (made public November 8) and some are currently being implemented.

(1) Countermeasures Related to Tank Leakage

a. Securing transfer destinations in the event tanks spring leaks

Currently, it is difficult to secure destinations for transferring the volumes necessary right away because the tanks for storing contaminated water are strained for capacity. Plans are being considered to replace tanks with welded-type tanks. As surplus capacity is gradually obtained, water will be sent for RO recirculation and processed by ALPS equipment, with open capacity being steadily secured in the area H tanks.

b. Promoting replacement with welded tanks

The flange-type tanks will be replaced with welded tanks. Work will proceed starting with the Type-1 flange-type tanks where the leak concerned was confirmed.

However, because at present the tanks for storing contaminated water are not in a state wherein they can be quickly replaced because they are strained for capacity, more welded-type tanks are being constructed and countermeasures being undertaken to curb the influx of contaminated water. Once surplus tank capacity can be secured, the plan is decided on an order of priorities taking leakage risks into consideration and then start the replacements.

Furthermore, the replacing of tanks will be handled in an order beginning with the highest priority area D tanks (notched tanks), followed by the horizontal cylindrical tanks in areas H1 and H2, and then the flange-type tanks (the construction project began in June 2014).

c. Provisional countermeasures until replacement with welded tanks occurs

The primary factors in the contaminated water leak at hand are presumed to have been the thermal expansion and contraction of the flanges due to changes in temperature; packing that projected from the flange surface due to tank water pressure; and leakage that occurred from the gaps at the bolts through the gaps concerned.

As a result of enhanced patrols (dosage measurements), at the present time no major leaks have been confirmed at the other tanks. However, since the possibility of the event at hand occurring at all of the flange-type tanks cannot be denied, in addition to continuing the enhanced patrols the measures to be taken in the future will include implementing waterproofing countermeasures at the bottom of tanks until they are replaced with welded tanks. Waterproofing by means of caulking the tank bottoms has been implemented as countermeasure that could be carried out immediately.

Also, to further improve reliability verification tests are being performed for filling in the baseplate bottom part with sealing materials and filling in the baseplate section (inside) with sealing materials. Based on the results of these tests, provisional countermeasures will be implemented. Partial mockups have been created so far with respect to both of these measures. Verification testing toward putting them into effect will continue, along with studies on designing and building equipment (filling in the baseplate section [inside] with sealing materials was implemented starting October 2014).

Also, investigations and studies as follows will be conducted regarding the other, Types 2 through 5 flange-style tanks.

- ① Conditions at one representative tank for each type of baseplate flange waterproofing structure will be checked (external appearance observations of the tank bottom flange surfaces using an underwater camera, etc.).
- ② The order of priorities for future responses will be studied based on the results of checking the waterproofing conditions of the baseplate flanges (in the event that same kind of event occurs, priority will be placed on Type-1 tanks where the leakage risk is high).
- ③ Furthermore, no indicators of the sort that would confirm leakage in particular were confirmed in the remote visual inspection done by underwater camera.

(Attachment—26)

(2) Measures to Prevent Leaks from Expanding

a. Closing of drain valves

The drain valves on the dike were closed as a measure to prevent leaks from expanding outside the dike.

b. Increasing the high of the tank dike

To prevent overflows of the standing water inside the tank dike, the dike was built up into an emergency dike by installing steel plates on the existing dike.

Further embankment work was done on the dikes as measure for increasing reliability. The height of the embankments basically will be such that it can retain a volume of leaked water equivalent to 1 of the 20 tanks in each area. Bearing in mind the buoyancy produced by water standing inside the dikes, the heights will be 0.75 m to 1.2 m, with those in area H4 north raised to 1.0 m.

- c. Double layering of dikes and preventing seepage into the earth on the surface of the ground between and among the dikes and the outer dikes

The dikes will be increased to two layers. Facing has also been done on the surface of the ground between and among the dikes and the outer dikes using concrete and resin spraying to prevent rainwater from seeping into the ground.

- d. Preventing influx into drainage ditches

The surfaces of drainage ditch B will be lined (already implemented) to prevent the further expansion of contamination.

Also, approximately 800 m of drainage ditch B—which was thought to have been where there was an influx from contaminated water storage facilities like the tanks was covered, as well as a stretch of approximately 440 m of drainage ditch C running from the confluence with drainage ditch B to the 35 m board outlet.

- e. Countermeasures for difficult-to-collect contaminated soil

Collection of contaminated soil has been completed, excluding in places where collection is difficult such as under the foundations of the tank area concerned and the equipment surrounding the radio relay station. Furthermore, the plans are conduct an investigation of the contaminated soil that remains in the lower part of the tank area foundations when the tanks are replaced and collect as much of it as possible.

Groundwater monitoring will also continue, along with efforts to improve the soil and prevent the spread of contamination via groundwater by drawing up groundwater (wellpoints), controlling rainwater influx through facing, and the use of adsorbents to trap strontium.

### (3) Countermeasures for Early Detection Purposes

- a. Enhanced patrolling

As section 5-2 (2) lays out, monitoring around the tanks is being enhanced.

- b. Control rainwater influx

To control the influx of rainwater inside the dikes, gutters were installed on the upper section of the tanks so it can be discharged outside the dikes. Also, gutters were similarly installed in the other tank areas as well. It is expect that through this it will be possible to curb approximately 60% of the rainwater influx.

- c. Installation of water gauges for each individual tank

Currently, storage tank water gauges have been installed in only one tank per cluster for managing water levels of the entire cluster when performing transfers. Now, however, gauges will be installed in each tank (already done for flange-type and already-built welded tanks). Ultimately, alarm functions will be installed and constant monitoring by remote will be made possible.

- d. Side ditch radiation monitors

Equipment to constantly monitor for gamma and beta radiation was installed and began operating on July 14 inside drainage ditch C—which could become a route for discharge into the sea—in order to detect rises in the concentration of radioactive materials in the discharge water in that water leaks from a tank. Also, construction of route for discharging water from drainage ditch C into the harbor is being undertaken, and tests to send water through and discharge part of it into the sea began on July 14. The plan is to steadily increase the volume water passing through and finally be able to discharge all of the water passing through into the sea.



(4) Countermeasures from an Operations Perspective (enhanced risk management)

Given that large amounts of contaminated water had leaked from an RO tank, there was renewed recognition at TEPCO of the fact that the issue of contaminated water was an urgent management problem. To grapple with these issues, it was thought that both accelerating decision making and gathering and pouring in resources were required. As a result of the attempt to drastically review the decommissioning regime and contaminated water response systems, the company on August 26, 2013 established under the direct of the president the Contaminated Water and Tank Countermeasures Headquarters.

Future contaminated water countermeasures include elements confirmed from the chain of circumstances related to operations management, and with the Headquarters at the center of the effort a thoroughgoing analysis of current conditions was carried out and risks controlled. Those efforts include working to clarify in-house procedures and responsibilities related to studies of policies and to countermeasures attendant upon risk management. TEPCO has been working to beef up its capacity to act in times of trouble and has been dealing with the contaminated water problem. Since April 2014, this work has been undertaken by the Daiichi D & D Engineering Company.

## 10. Attachments

Attachment—1	Event Chronology	24
Attachment—2	Result of Emergency Measures	27
Attachment—3	Investigation of Radiation Dose on Ground Surface	29
Attachment—4	Survey and Collection of Contaminated Soil	31
Attachment—5	Collection of Soil Inside the Drainage Ditch	32
Attachment—6	Collection and Drainage of Standing Water Inside the Dike	36
Attachment—7	Patrol Record	37
Attachment—8	Investigations Around the Tank	38
Attachment—9	Types of Flange Tanks	40
Attachment—10	Inspection of Similar Locations (same-type tanks)	43
Attachment—11	Locations of Tank Areas and Drainage Ditches	44
Attachment—12	Assessment of the Amount of Leakage from Tanks	45
Attachment—13	Leaked Amounts of Radioactive Material from the Tank Concerned	46
Attachment—14	Boring Survey Results	47
Attachment—15	Results of Deep Groundwater Contamination Investigation	51
Attachment—16	Results of Investigation and Evaluation of Impact on Groundwater Bypass	54
Attachment—17	Assessment of Amount of Radioactive Materials Collected	56
Attachment—18	Results of Investigations of Drainage Ditches B and C	60
Attachment—19	Results of Investigations into Impact on Ocean	62
Attachment—20	Summary of Investigations into Locations of Tank Leaks (pre-dismantling)	65
Attachment—21	Summary of Investigations into Locations of Tank Leaks (during and after dismantling)	70
Attachment—22	Considerations regarding Results of Root Causes Investigation of Tank Leakage	77
Attachment—23	Estimated Area of Leakage Based on Leak Rate	79
Attachment—24	Results of Checks for External Radiation Exposure due to Beta Radiation for Workers around Area H4 North	80
Attachment—25	Results of Concrete Foundations Investigation	81
Attachment—26	Countermeasures	82

### Event Chronology (all times approximate)

#### August 18, 2013

5:00 p.m. - Regular on-site patrol discovers standing water inside the dike (hereinafter, “the dike concerned”) installed surrounding the RO concentrated water reservoir of area H4 north. However, the presence of standing water that can be clearly noticed outside the dike is unconfirmed.

#### August 19, 2013

9:50 a.m. - TEPCO employee discovers water standing within the dike concerned, as well as standing water in two locations outside the dike concerned (see Figure 1).

9:51 a.m. - Two drain valves where outflows have been confirmed are closed, as well as one adjacent drain valve

9:55 a.m. - Employee who confirmed presence of standing water contacts recovery team leader (Emergency Response Headquarters)

2:28 p.m. - Situation assessed as falling under Fukushima Daiichi Regulations Article 18, item 12

4:00 p.m. to 5:00 p.m. - Surface dose equivalent rates for surface of ground outside sandbag dikes installed around area H4 north rates, etc., are measured, confirming point with maximum of 95.55 mSv/h (70  $\mu$ m dose equivalent rate [beta radiation])

7:00 p.m. to midnight - Work begins to collect water standing inside the dike concerned (temporary pumps are used to draw water up into into temporary tanks while water absorbing mats are laid down inside the dike and sandbags are put into place [see Figure 2]; approx. 4 m<sup>3</sup> of water is collected)

#### August 20, 2013

1:00 a.m. - Confirmation that standing water appears to be spreading from near RO concentrated water reservoir No. 5 (hereinafter, “the tank concerned”) in the area H4 north cluster I

6:30 a.m. to 2:30 p.m. - Emergency countermeasures (embankments, use of impermeable sheets, etc.) implemented to prevent spread of leakage around area H4 north and outflow from area H4 north to drainage ditches on east side (hereinafter, “the drainage ditches concerned”)

7:00 a.m. - Depth of standing water inside the dike concerned confirmed to have risen up to approximately 3 cm

7:00 a.m. - Top cover of tank concerned opened to visually check water level; surface of water that should have been approx. 0.5 m below ceiling confirmed as having dropped to approx. 3 m below

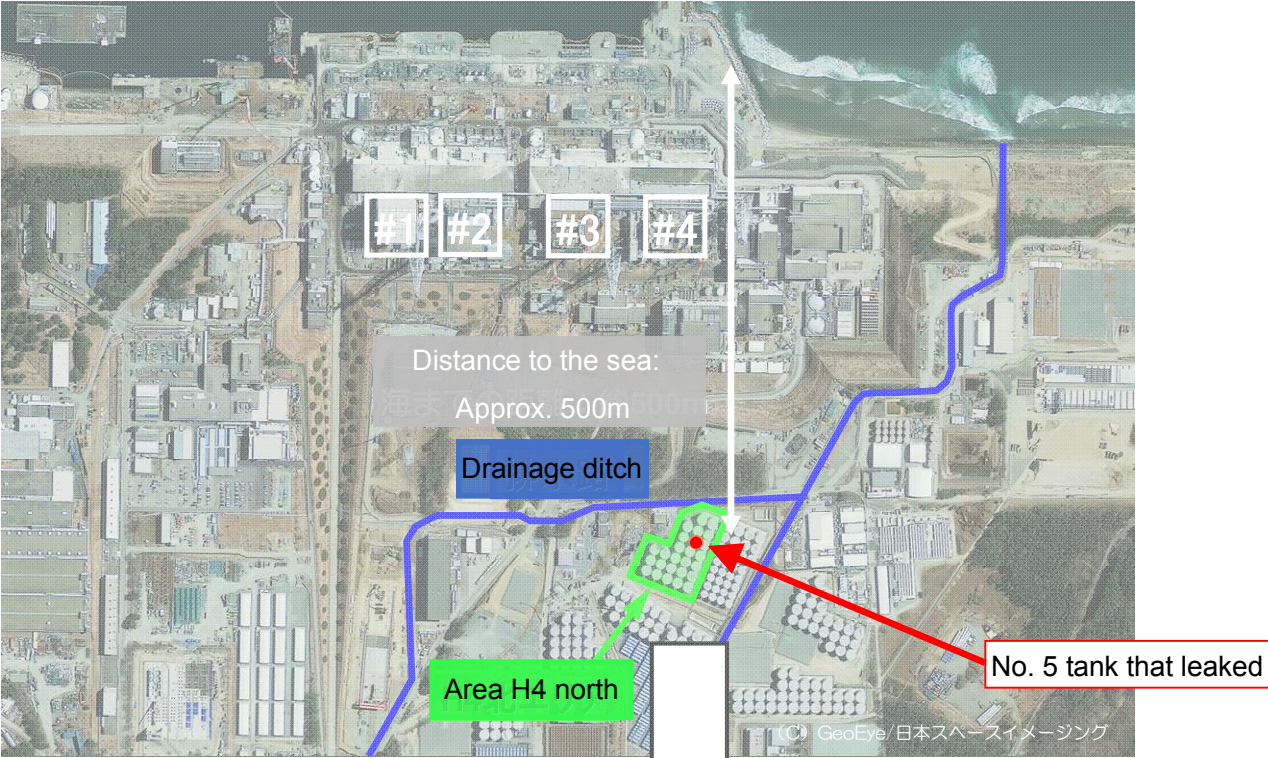
9:40 a.m. - Determination made of RO concentrated water leakage from tank concerned

9:55 p.m. to 9:13 p.m. following day - RO concentrated water in tank concerned transferred using temporary pump to RO concentrated water reservoir No. 10 situated in area H4 north cluster B

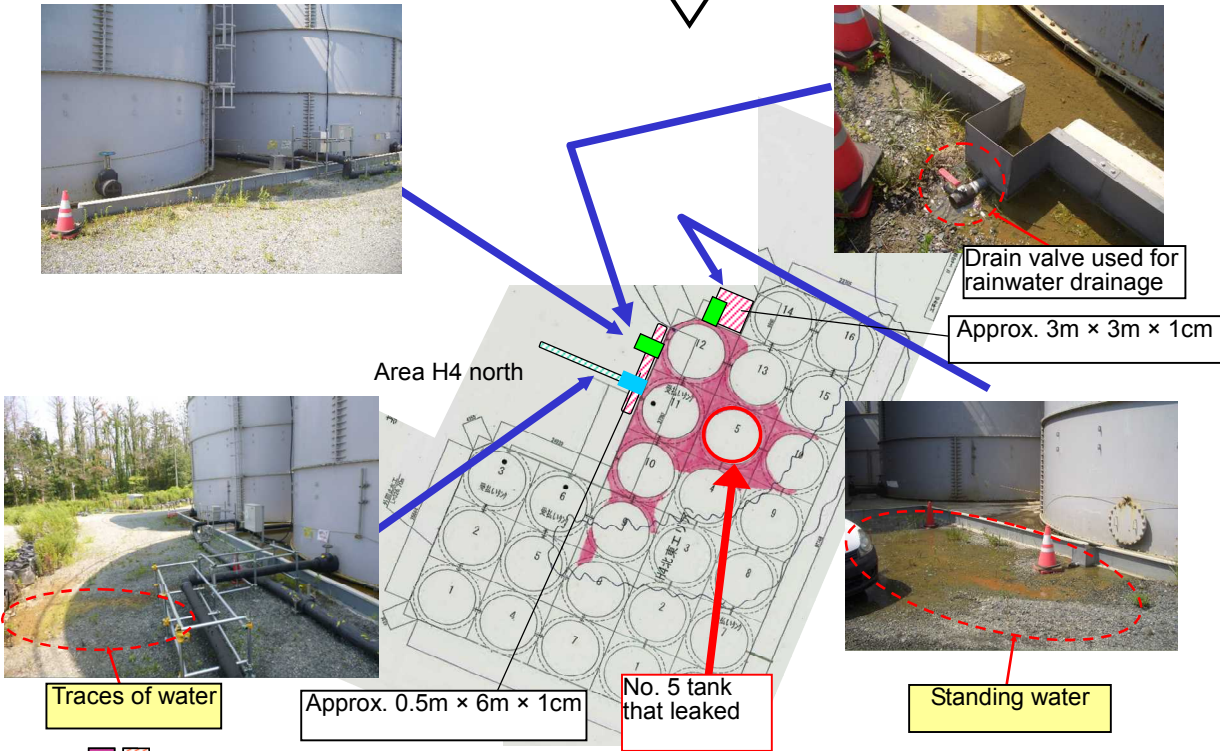
9:55 p.m. to 3:00 p.m. on 8/22 - Water in temporary tank transferred using temporary pump to RO concentrated water reservoir No. 10 situated in area H4 north cluster B (approx. 8 m<sup>3</sup>)

#### August 21, 2013

2:30 p.m. to 3:10 p.m. - Surface dose equivalent rate for concrete walls of drainage ditch concerned measured, confirming maximum dose of 5.80 mSv/h (70  $\mu$ m dose equivalent rate [beta radiation])

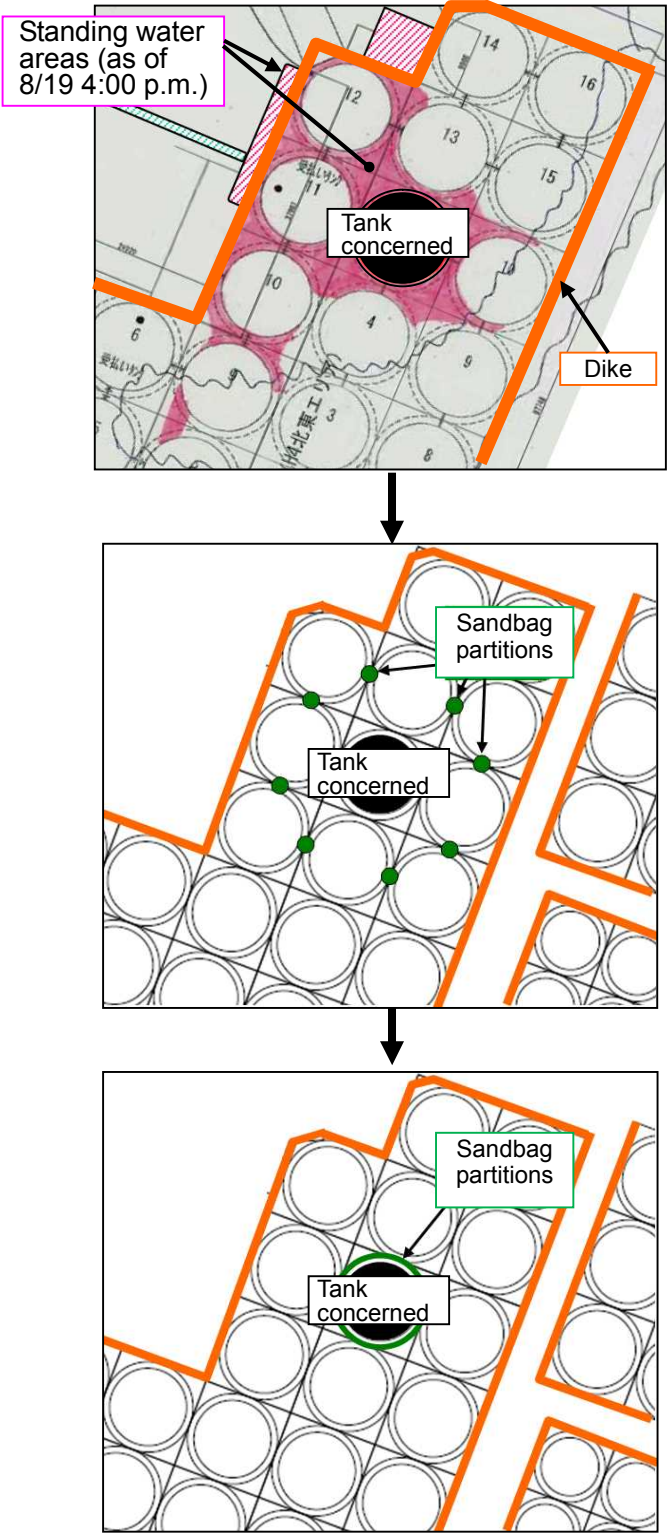


Enlargement



- : Areas with standing water (as of 8/19 4:00 p.m.)
- : Drain valve and catch basin where an outflow was confirmed
- : Nearby drain valve that was closed and its catch basin

**Fig. 1 Water leak locations**



On Aug. 19, around 7:00 p.m. to midnight, absorbing mats were installed in places where the leak from the No. 5 tank was conspicuous and sandbags were installed around the tank to prevent the water from spreading in the dike.

Sandbags were installed accompanying the collection of leaked water and identification of leakage locations.

Ultimately, sandbags were installed around the tank concerned. On August 21, at 9:13 p.m., RO concentrated water in the tank concerned was completed being transferred to a different tank.

**Fig. 2 Installation of sandbags**

Result of Emergency Measures

1. Measures to prevent spreading of the leakage from the tank concerned (area H4 north)

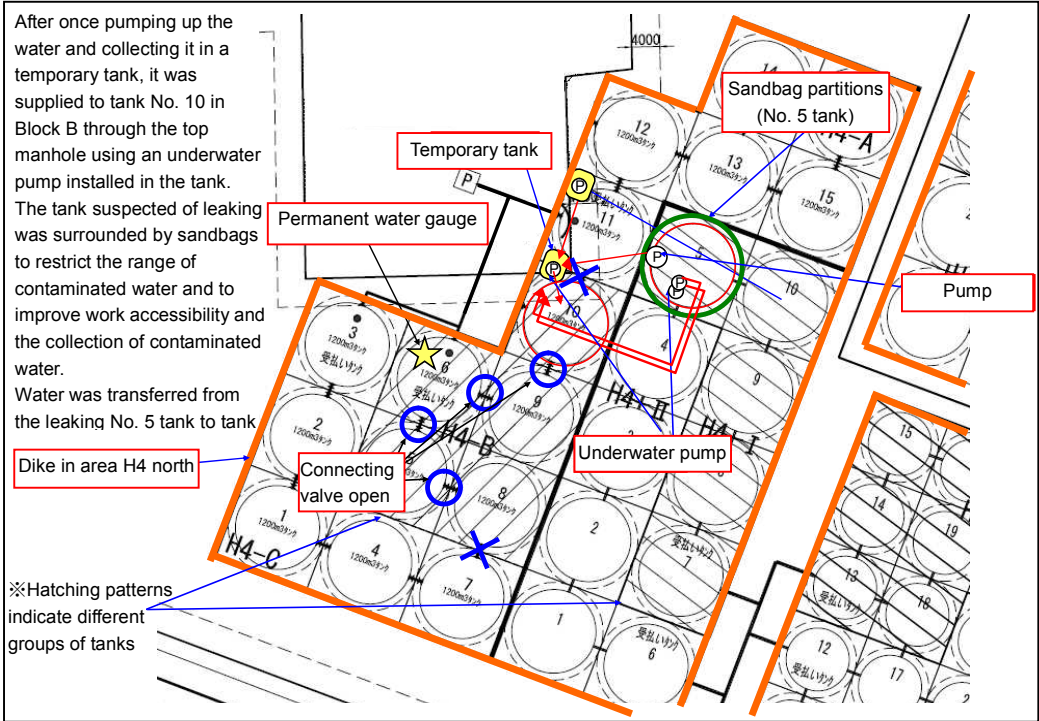


Fig. 1 Transfer of leaked water and tank water



Fig. 2 Installation of underwater pump (temporary) and hose

2. Measures to prevent spreading of the leakage around area H4 north

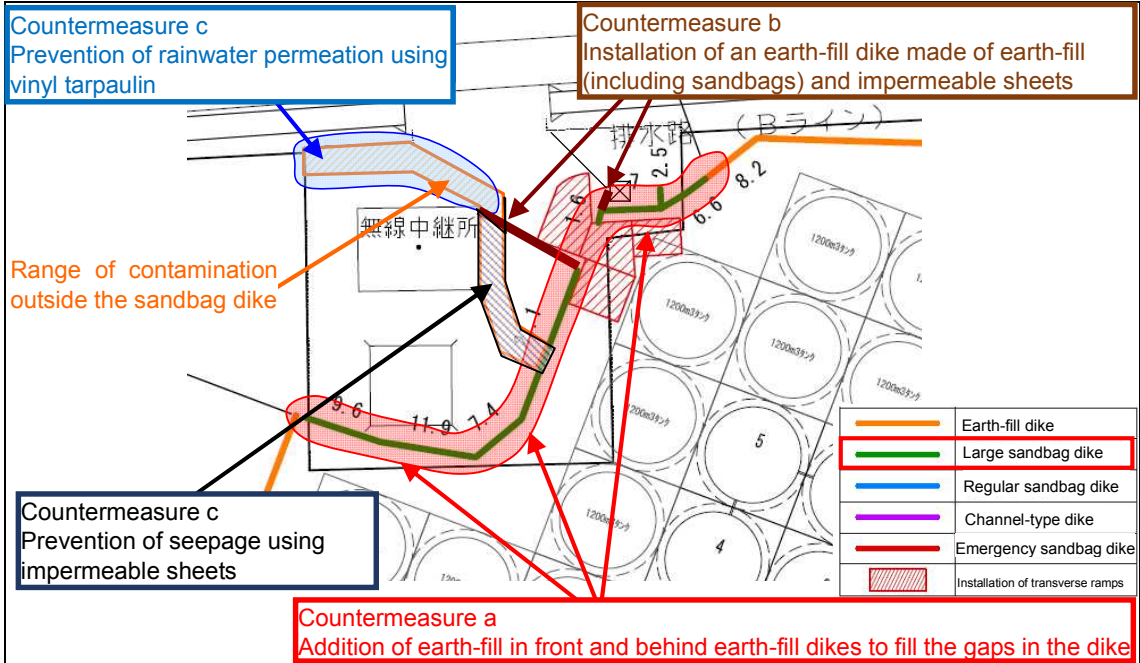


Fig. 3 Countermeasures outside the sandbag dikes



Fig. 4 Installation of sandbags

### Investigation of Radiation Dose on Ground Surface

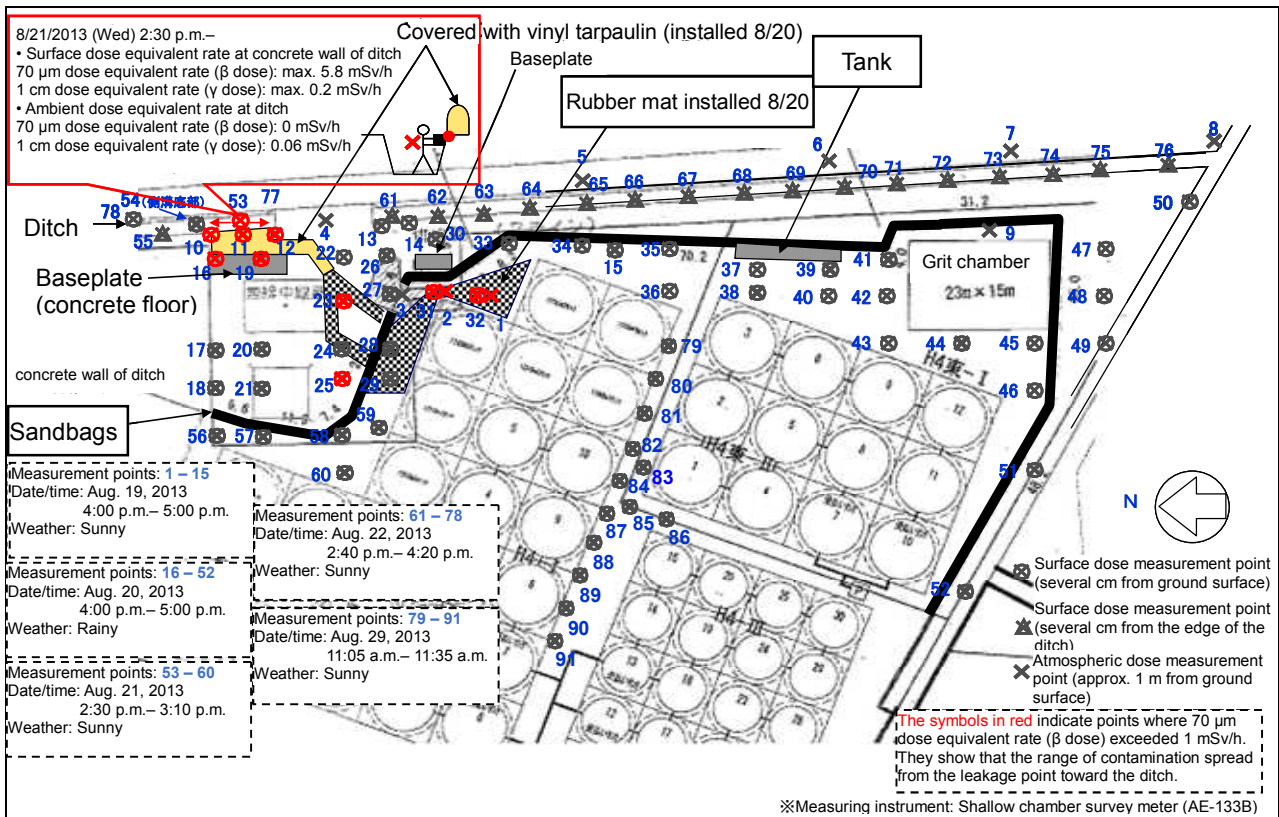


Fig. 1 Investigation of radiation dose on ground surface (measurement points)

Measurement points: 1 – 15 Date/time: Aug. 19, 2013 4:00 p.m. – 5:00 p.m.					Measurement points: 16 – 30 Date/time: Aug. 20, 2013 4:00 p.m. – 5:00 p.m.						
Measurement point	Date	Dose rate		Weather	Remarks	Measurement point	Date	Dose rate		Weather	Remarks
		70 μm dose equivalent rate (β dose)	1 cm dose equivalent rate (γ dose)					70 μm dose equivalent rate (β dose)	1 cm dose equivalent rate (γ dose)		
1	8/19	>98.5	1.5	Sunny	No rubber mat; height: approx. 50 cm	16	8/20	8.96	0.04	Rainy	On concrete
2	8/19	5.4	0.1	Sunny	No rubber mat	17	8/20	0.03	0.10	Rainy	
3	8/19	0.03	0.05	Sunny	No rubber mat	18	8/20	0.02	0.08	Rainy	
4	8/19	0	0.04	Sunny		19	8/20	1.96	0.04	Rainy	On concrete
5	8/19	0	0.06	Sunny		20	8/20	0.02	0.08	Rainy	
6	8/19	0	0.06	Sunny		21	8/20	0.09	0.08	Rainy	
7	8/19	0	0.045	Sunny		22	8/20	0.12	0.03	Rainy	
8	8/19	0	0.06	Sunny		23	8/20	2.90	0.10	Rainy	
9	8/19	0.135	0.015	Sunny		24	8/20	0.04	0.16	Rainy	On rubber mat
10	8/19	89.64	0.36	Sunny	No vinyl tarpaulin	25	8/20	1.24	0.06	Rainy	
11	8/19	95.55	0.45	Sunny	No vinyl tarpaulin	26	8/20	0	0.11	Rainy	
12	8/19	89.65	0.35	Sunny	No vinyl tarpaulin	27	8/20	0.04	0.03	Rainy	Same as No. 3
13	8/19	0.28	0.07	Sunny		28	8/20	0.08	0.03	Rainy	On rubber mat
14	8/19	0.01	0.11	Sunny		29	8/20	0.8	1.2	Rainy	On rubber mat
15	8/19	0.009	0.015	Sunny		30	8/20	0.02	0.12	Rainy	

※Measuring instrument: Shallow chamber survey meter (AE-133B)

Fig. 2 Measurements of dose equivalent rate (measurement points 1 – 30)



Measurement points: 31 – 52 Date/time: Aug. 20, 2013 4:00 p.m. – 5:00 p.m.					Measurement points: 53 – 60 Date/time: Aug. 21, 2013 2:30 p.m. – 3:10 p.m.						
Unit : [mSv/h]					Unit : [mSv/h]						
Measurement point	Date	Dose rate		Weather	Remarks	Measurement point	Date	Dose rate		Weather	Remarks
		70 µm dose equivalent rate (β dose)	1 cm dose equivalent rate (γ dose)					70 µm dose equivalent rate (β dose)	1 cm dose equivalent rate (γ dose)		
31	8/20	4.89	0.11	Rainy	On rubber mat Same as No. 2	46	8/20	0.01	0.02	Rainy	
32	8/20	1.5	1	Rainy	On rubber mat Same as No. 1	47	8/20	0	0.04	Rainy	
33	8/20	0	0.06	Rainy		48	8/20	0	0.04	Rainy	
34	8/20	0.06	0.02	Rainy		49	8/20	0.03	0.03	Rainy	
35	8/20	0.01	0.02	Rainy		50	8/20	0.04	0.03	Rainy	
36	8/20	0	0.02	Rainy		51	8/20	0.02	0.03	Rainy	
37	8/20	0.03	0.04	Rainy		52	8/20	0.02	0.03	Rainy	
38	8/20	0.01	0.04	Rainy		53	8/21	5.80	0.20	Sunny	
39	8/20	0	0.04	Rainy		54	8/21	0	0.06	Sunny	
40	8/20	0.03	0.03	Rainy		55	8/21	0.02	0.08	Sunny	
41	8/20	0	0.03	Rainy		56	8/21	0	0.05	Sunny	
42	8/20	0	0.03	Rainy		57	8/21	0.01	0.04	Sunny	
43	8/20	0.06	0.03	Rainy		58	8/21	0.01	0.04	Sunny	
44	8/20	0	0.03	Rainy		59	8/21	0.01	0.04	Sunny	
45	8/20	0	0.03	Rainy		60	8/21	0	0.05	Sunny	

※Measuring instrument: Shallow chamber survey meter (AE-133B)

Fig. 3 Measurements of dose equivalent rate (measurement points 31 – 60)

Measurement points: 61 – 78 Date/time: Aug. 22, 2013 2:40 p.m. – 4:20 p.m.					Measurement points: 79 – 91 Date/time: Aug. 29, 2013 11:05 p.m. – 11:35 p.m.						
Unit : [mSv/h]					Unit : [mSv/h]						
Measurement point	Date	Dose rate		Weather	Remarks	Measurement point	Date	Dose rate		Weather	Remarks
		70 µm dose equivalent rate (β dose)	1 cm dose equivalent rate (γ dose)					70 µm dose equivalent rate (β dose)	1 cm dose equivalent rate (γ dose)		
61	8/22	0.005	0.010	Sunny		79	8/29	0.43	0.02	Sunny	
62	8/22	0.004	0.010	Sunny		80	8/29	0.285	0.015	Sunny	
63	8/22	0.005	0.011	Sunny		81	8/29	0.825	0.025	Sunny	
64	8/22	0.004	0.011	Sunny		82	8/29	0.04	0.02	Sunny	
65	8/22	0.001	0.011	Sunny		83	8/29	0.035	0.025	Sunny	
66	8/22	0.002	0.011	Sunny		84	8/29	0.17	0.03	Sunny	
67	8/22	0	0.012	Sunny		85	8/29	0.005	0.03	Sunny	
68	8/22	0.002	0.013	Sunny		86	8/29	0	0.04	Sunny	
69	8/22	0.003	0.011	Sunny		87	8/29	0.07	0.03	Sunny	
70	8/22	0.001	0.011	Sunny		88	8/29	0.17	0.03	Sunny	
71	8/22	0.001	0.011	Sunny		89	8/29	0.20	0.10	Sunny	
72	8/22	0.002	0.011	Sunny		90	8/29	0.21	0.04	Sunny	
73	8/22	0	0.010	Sunny		91	8/29	0.12	0.03	Sunny	
74	8/22	0.001	0.010	Sunny							
75	8/22	0.001	0.009	Sunny							
76	8/22	0	0.010	Sunny							
77	8/22	0.143	0.007	Sunny	On vinyl tarpaulin Same as No. 53						
78	8/22	0.002	0.008	Sunny							

※Measuring instrument: Shallow chamber survey meter (AE-133B)

Fig. 4 Measurements of dose equivalent rate (measurement points 61 – 91)

Survey and Collection of Contaminated Soil

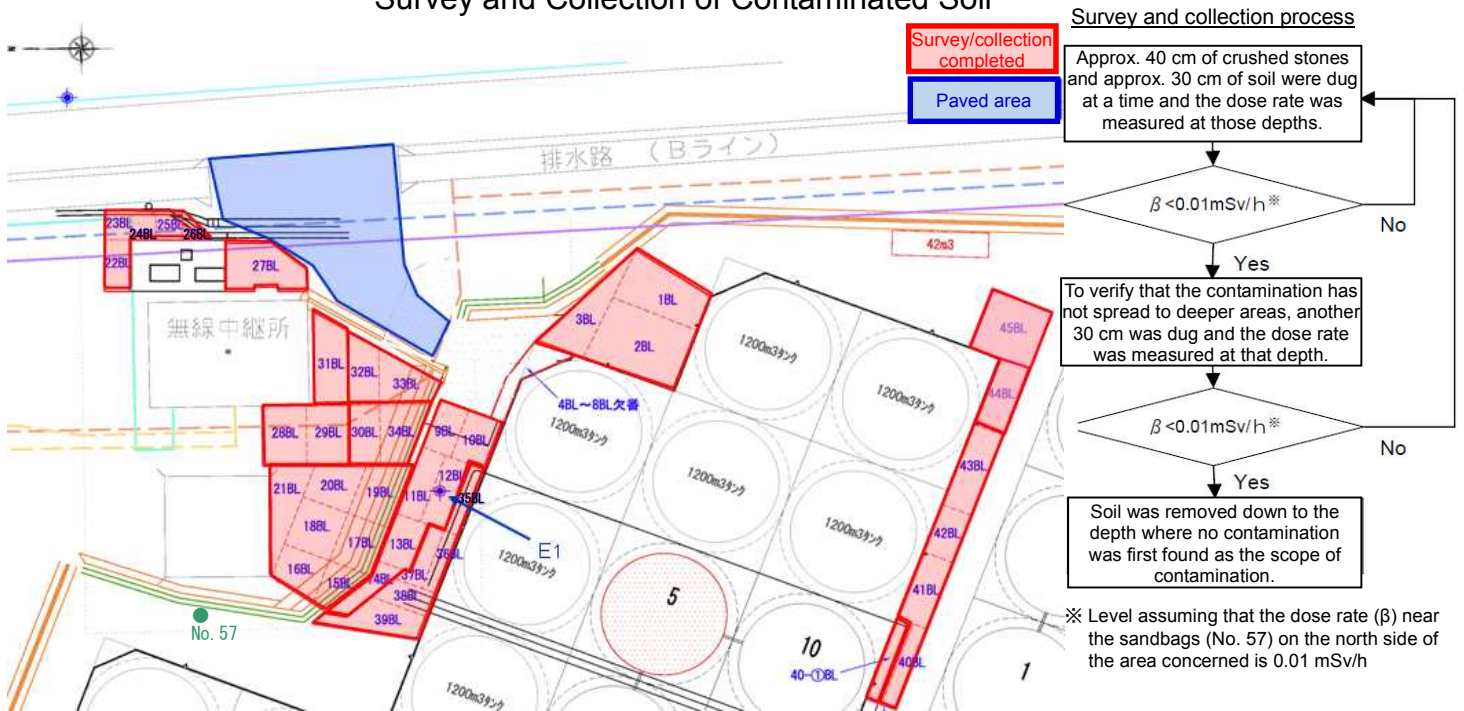


Fig. 1 Survey and collection of contaminated soil—Overall ground view and process

Block	Dose rate measurement depth	Dose rate (mSv/h)	Amount of soil removed (m <sup>3</sup> )	Remarks	Block	Dose rate measurement depth	Dose rate (mSv/h)	Amount of soil removed (m <sup>3</sup> )	Remarks
1	GL-3000	0.009	60		27	GL-1000	0.008	29	
2	GL-3000	0.009	96		28	GL-2500	0.040	26	In consideration of safety
3	GL-3000	0.009	64		29	GL-2500	0.10	17	In consideration of safety
9	GL-1080	0.005	16		30	GL-1000	0.008	18	
10	GL-1480	0.008	24		31	GL-2500	0.110	23	In consideration of safety
11	GL-840	0.008	15		32	GL-3000	0.007	30	
12	GL-860	0.008	16		33	GL-3000	0.130	10	In consideration of safety
13	GL-550	0.009	10		34	GL-1500	0.006	6	
14	GL-400	0.006	3		35-1	GL-2000	13.00	10	In consideration of safety
15	GL=1050	0.009	17		35-2	GL-2000	1.70	9	In consideration of safety
16	GL-900	0.004	21		36	GL-2000	0.80	19	In consideration of safety
17	GL-600	0.006	10		37	GL-2000	2.20	15	In consideration of safety
18	GL-600	0.007	15		38	GL-800	0.007	25	
19	GL-700	0.004	18		39	GL-1000	0.008	27	
20	GL-600	0.006	21		40	GL-1600	0.008	16	
21	GL-600	0.008	3		40-1	GL-1800	0.007	16	
22	GL-900	0.005	7		41	GL-1500	0.008	24	
23	GL-900	0.008	3		42	GL-1300	0.009	31	
24	GL-1650	0.35	3	Obstacle (buried object)	43	GL-1500	0.008	19	
25	GL-1000	0.34	9	Obstacle (buried object)	44	GL-1500	0.007	32	
26	GL-1000	0.35	6	Obstacle (buried object)	45	GL-1500	0.005	39	

Total volume of soil removed 878 m<sup>3</sup>

Area with a dose rate over 0.01 mSv/h  
 Area with a dose rate over 0.01 mSv/h deep down

Fig. 2 Dose rates of contaminated soil and the volume of soil removed

Collection of Soil Inside the Drainage Ditch

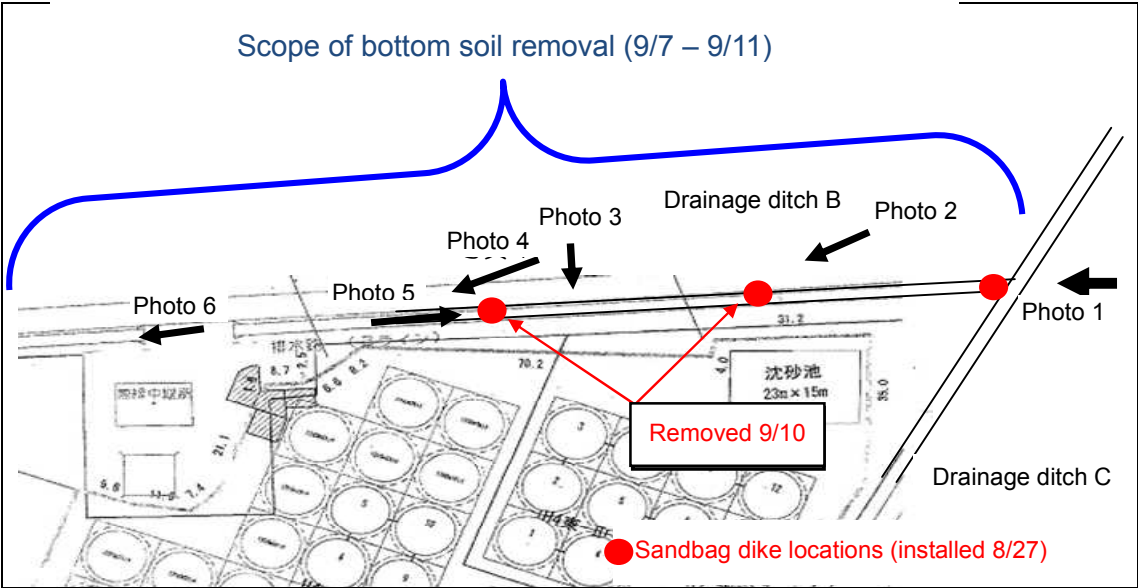


Fig. 1 Collection of soil inside the drainage ditch



Sandbag dike inside the drainage ditch (8/27)

Photo 2



Photo 3



Collection of soil in the drainage ditch (photo taken 9/7)



Photo 4

Cleaning the drainage ditch (photo taken 9/9)



Photo 5

Removal of the sandbag dike in the drainage ditch (photo taken 9/10)

Photo 6



Installation of lining material (photo taken 10/10)

## Collection and Drainage of Standing Water Inside the Dike

### ■ Collection of standing water inside the dike

Standing water inside the dike that does not satisfy the provisional effluent standard<sup>※1</sup> was collected in tanks

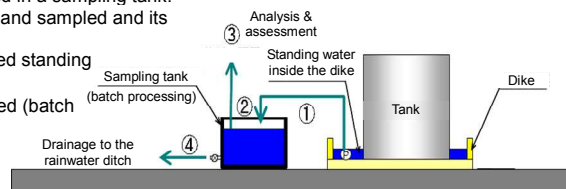
### ■ Method of how standing water inside the dike should be drained

① [Temporary storage] Standing water in the dike is temporarily stored in a sampling tank.

② [Sampling & measurement] The temporarily stored water is mixed and sampled and its radiation level measured.

③ [Evaluation] It is verified that the measurement result of the collected standing water satisfies the provisional effluent standard<sup>※1</sup>.

④ [Drainage] The standing water stored in the sampling tank is drained (batch processing)



### ■ Drainage of standing water inside the dike (provisional operation) [within the year]

#### ● Basic case

Collection, analysis and drainage of standing water from the sampling tank (batch processing)

#### ● In the event a prompt response is required

(i) [Sampling] Standing water is collected from at least four locations inside the dike (if rectangular, from the four corners of the dike, or corresponding points).

(ii) [Measurement] The radiation level of the sampled water is measured.

(iii) [Evaluation] It is verified that the results of the measurement of the sampled water (previous (most recent) measurement and current measurement) satisfy the provisional effluent standard<sup>※1</sup>.

(iv) [Drainage] The water is drained from the dike by opening the rainwater drainage valve or by using a drainage pump.

※1 Provisional effluent standard: Effluent must satisfy requirements (1) – (5) below.

(1) Cs-134: Less than 15 Bq/L

(2) Cs-137: Less than 25 Bq/L

(3) No other  $\gamma$  nuclides are detected (excl. natural nuclides)

(no  $\gamma$  nuclides are detected as a result of performing measurements for confirming (1) and (2) in a Ge semiconductor detector)

(4) Sr-90: Less than 10 Bq/L (measured by a simple measuring method)

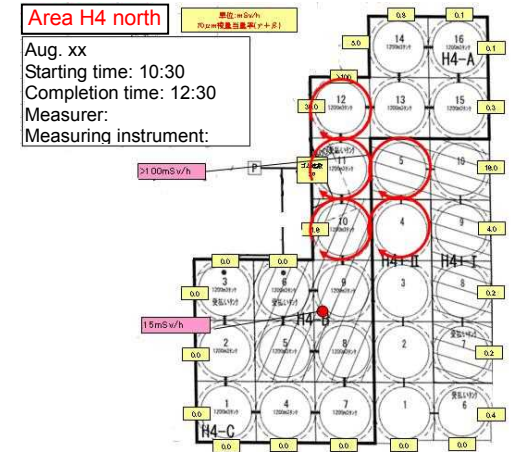
(5) With reference to water quality inside the tank, other nuclides should also satisfy the announced concentration standard.

# Patrol Record

[Conventional record]

場所	機器名称	月 日	8/18	8/19	8/20	8/21	8/22	8/23	8/24
			日	月	火	水	木	金	土
ヤード	濃縮廃液貯槽(A010) [H2エリア]		レ	レ	レ				
	RO濃縮水貯槽3(A016)・移送ポンプ		レ	レ	レ				
	RO濃縮水貯槽4(A017)・移送ポンプ		レ	レ	レ				
	RO濃縮水貯槽5(A021)・移送ポンプ		レ						
	RO濃縮水貯槽8(A024)・移送ポンプ		レ	×	×				
	RO濃縮水貯槽6移送ポンプ(A022)		レ						
	RO濃縮水貯槽9(A025) [H5北エリア]		レ	レ	レ				

記事  
8/18, 19, 20, 21, 22, 23 ヤードタンク類の巡視 AM・PM実施



37

[Sample form after modification]

場所	機器名称	点検項目	8/18 日				記事
			Discovery of standing water				
			7時	12時	16時	24時	
ヤード	濃縮廃液貯槽(A010)No.1タンク [H2エリア]	タンクの変形は無い	レ<例>	レ<例>	レ<例>	レ<例>	
		フランジ部の錆有無	レ<例>	レ<例>	レ<例>	レ<例>	
		水漏れは無い	レ<例>	レ<例>	レ<例>	レ<例>	
		タンク周辺の水溜まり有無	レ<例>	レ<例>	レ<例>	レ<例>	
		タンク側面最大放射線量	〇〇<例>	-	〇〇<例>	-	単位: $\mu\text{Sv/h}$
		タンク底部フランジ最大放射線量	〇〇<例>	-	〇〇<例>	-	単位: $\mu\text{Sv/h}$
		連絡弁「開」「閉」	開 or 閉<例>	開 or 閉<例>	開 or 閉<例>	開 or 閉<例>	
		タンク水位	-	〇〇<例>	-	-	単位: m
		タンクの変形は無い	レ<例>	レ<例>	レ<例>	レ<例>	
		フランジ部の錆有無	レ<例>	レ<例>	レ<例>	レ<例>	
ヤード	濃縮廃液貯槽(A010)No.2タンク [H2エリア]	水漏れは無い	レ<例>	レ<例>	レ<例>	レ<例>	
		タンク周辺の水溜まり有無	レ<例>	レ<例>	レ<例>	レ<例>	
		タンク側面最大放射線量	〇〇<例>	-	〇〇<例>	-	単位: $\mu\text{Sv/h}$
		タンク底部フランジ最大放射線量	〇〇<例>	-	〇〇<例>	-	単位: $\mu\text{Sv/h}$
		連絡弁「開」「閉」	開 or 閉<例>	開 or 閉<例>	開 or 閉<例>	開 or 閉<例>	
		タンク水位	-	〇〇<例>	-	-	単位: m

(Measurement results are managed by area and by tank on a detailed map)

Confirmation of water level in tanks

Measurement of radiation dose



### Investigations Around the Tank

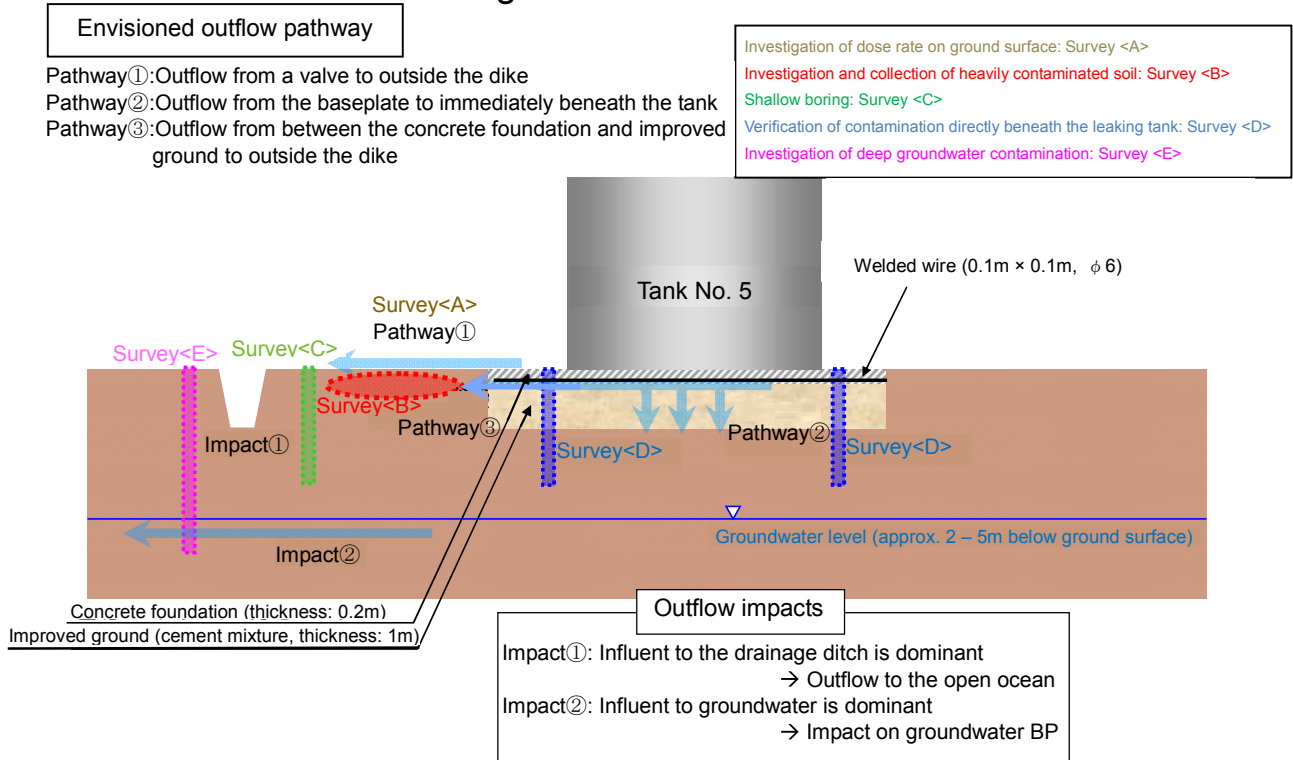


Fig. 1 Investigations around the tank concerned

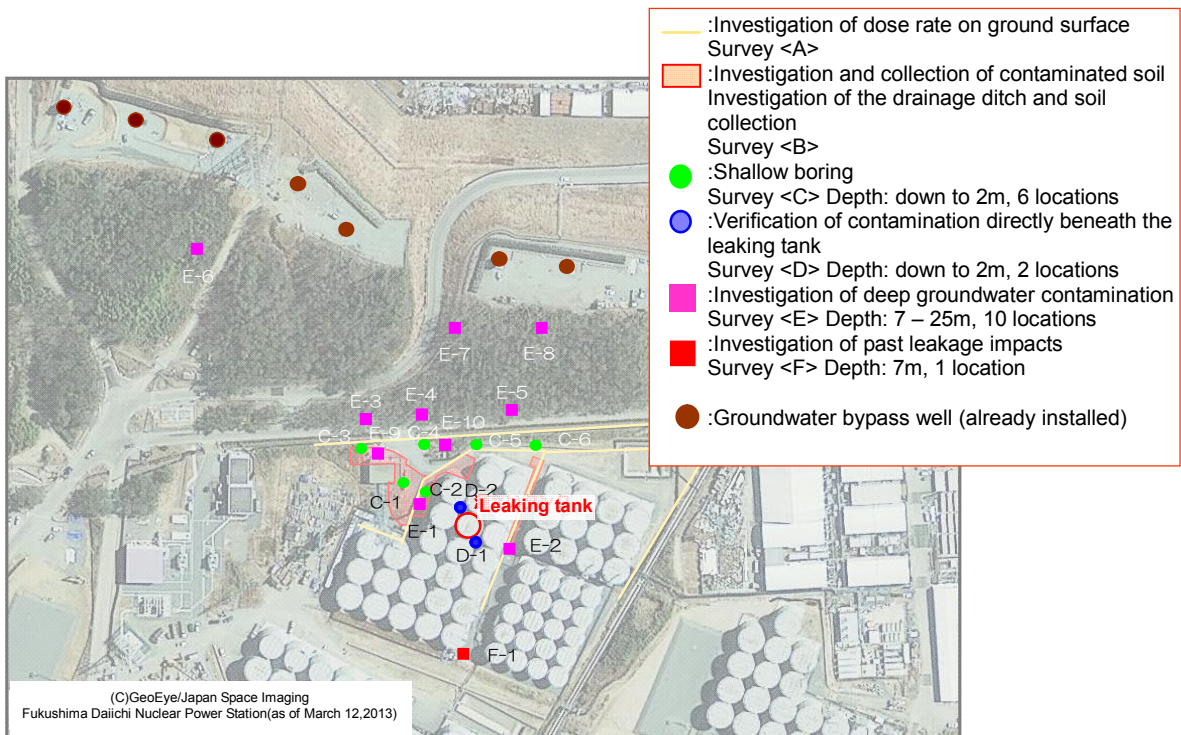


Fig. 2 Investigation locations around the tank concerned (as of March 31, 2014)

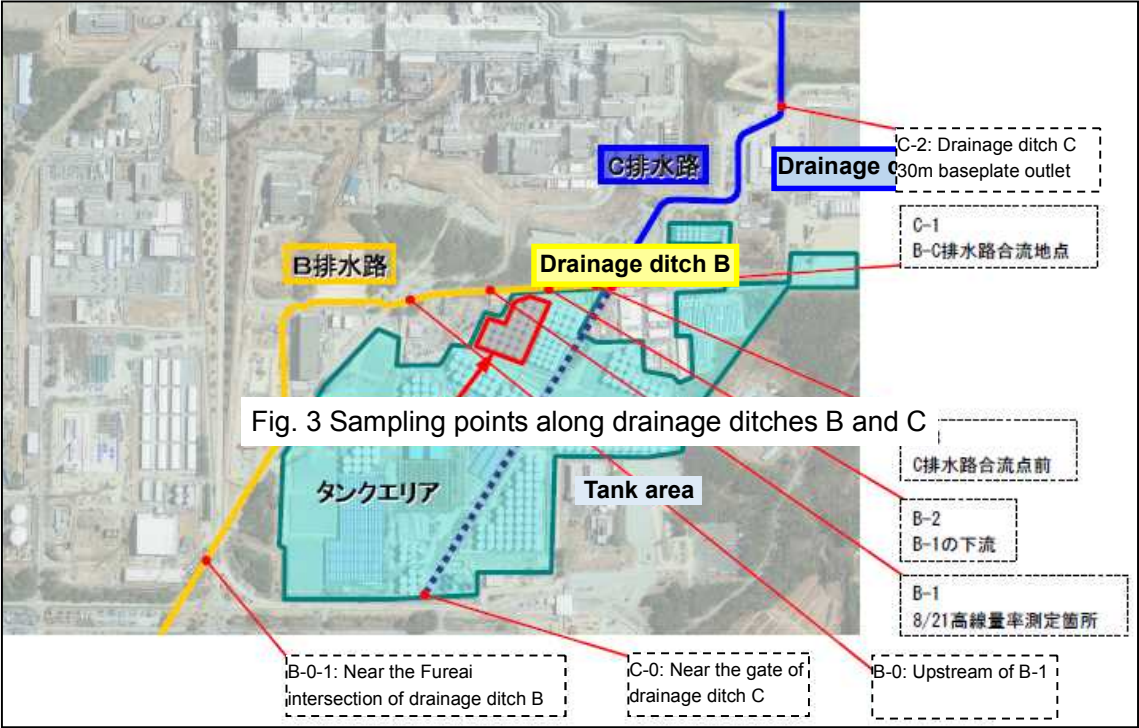


Fig. 3 Sampling points along drainage ditches B and C

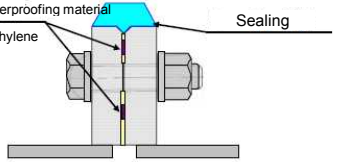

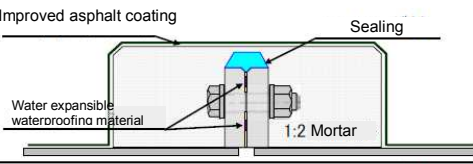

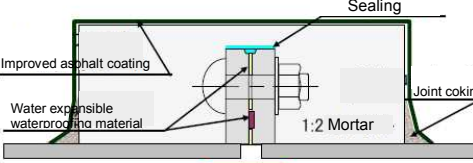

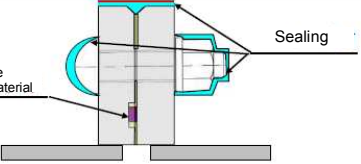

C-1: Junction of drainage ditches B and C

B-3: Point before the junction with drainage ditch C

B-2: Downstream of B-1

B-1: Point where high dose rate was measured on 8/21

### Types of Flange Tanks






Type	Cross-section of baseplate waterproofing construction	Installation example	Number of tanks
TYPE-1 ※	 <p>Water expansive waterproofing material</p> <p>Sealing</p> <p>TYPE-1' uses polyethylene waterproofing resin</p>		120
TYPE-1'			20
TYPE-2	 <p>Improved asphalt coating</p> <p>Water expansive waterproofing material</p> <p>1:2 Mortar</p> <p>Sealing</p>		37
TYPE-3 TYPE-4	 <p>Improved asphalt coating</p> <p>Water expansive waterproofing material</p> <p>1:2 Mortar</p> <p>Joint coking</p> <p>Sealing</p>		59
TYPE-5	 <p>Water expansive waterproofing material</p> <p>Sealing</p>		69

※Tank that was found to be leaking

Fig. 1 Baseplate construction by tank type



<Legend>

	TYPE1
	TYPE2
	TYPE3
	TYPE4
	TYPE5

As of December 2013

Fig. 2 Locations of flange-type tanks by type (1/2)

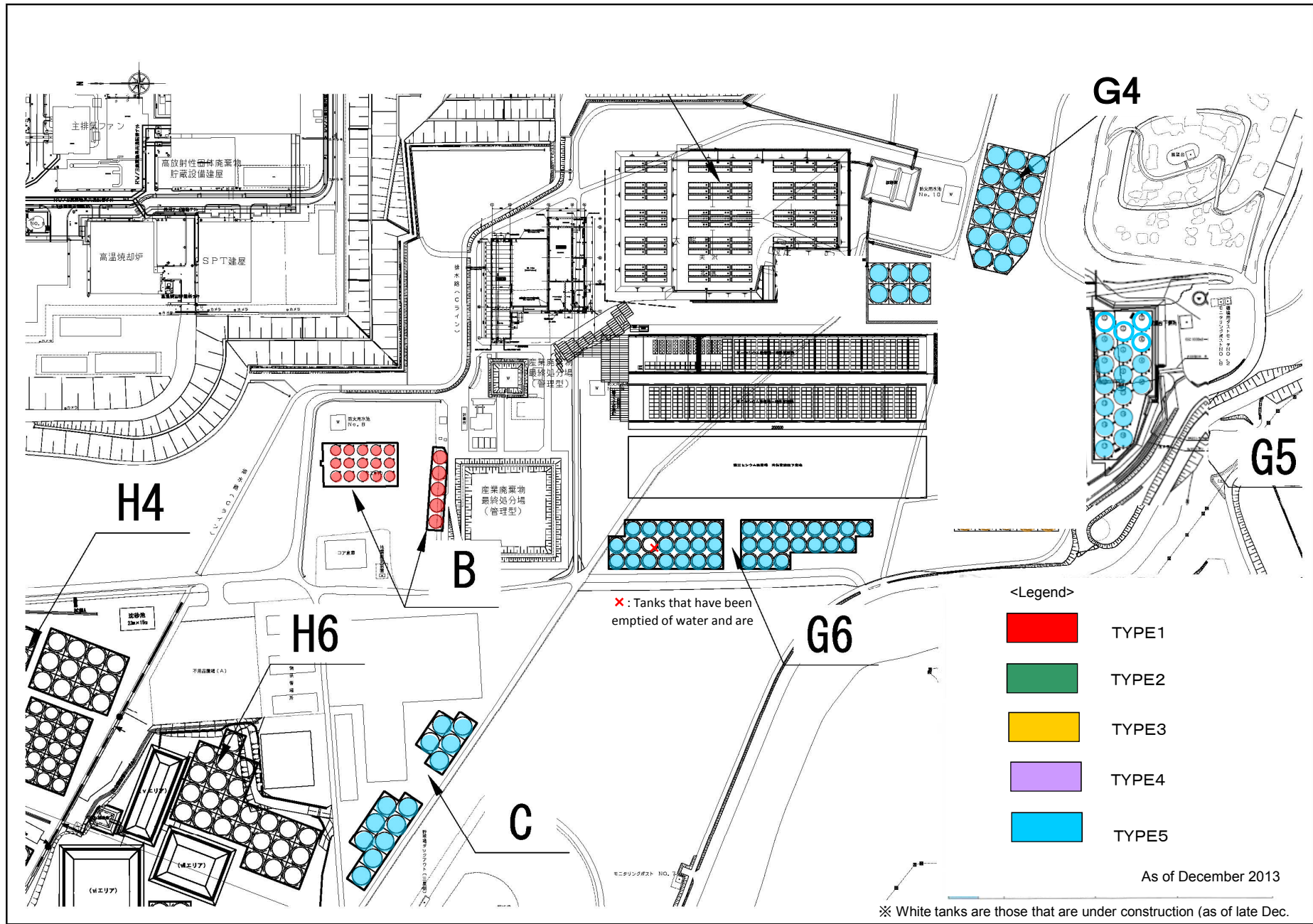


Fig. 3 Locations of flange-type tanks by type (2/2)

Inspection of Similar Locations (same-type tanks)

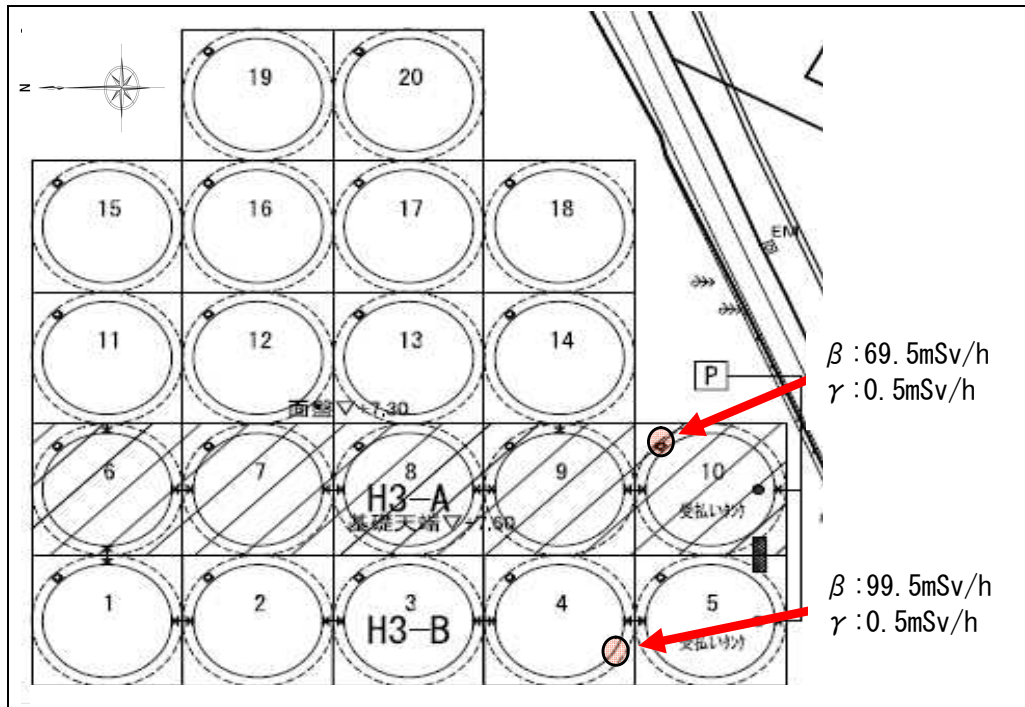


Fig. 1 Enlarged view of tanks in area H3



Fig. 2 High-dose area in tank No. 4



Fig. 3 High-dose area in tank No. 10

Locations of Tank Areas and Drainage Ditches

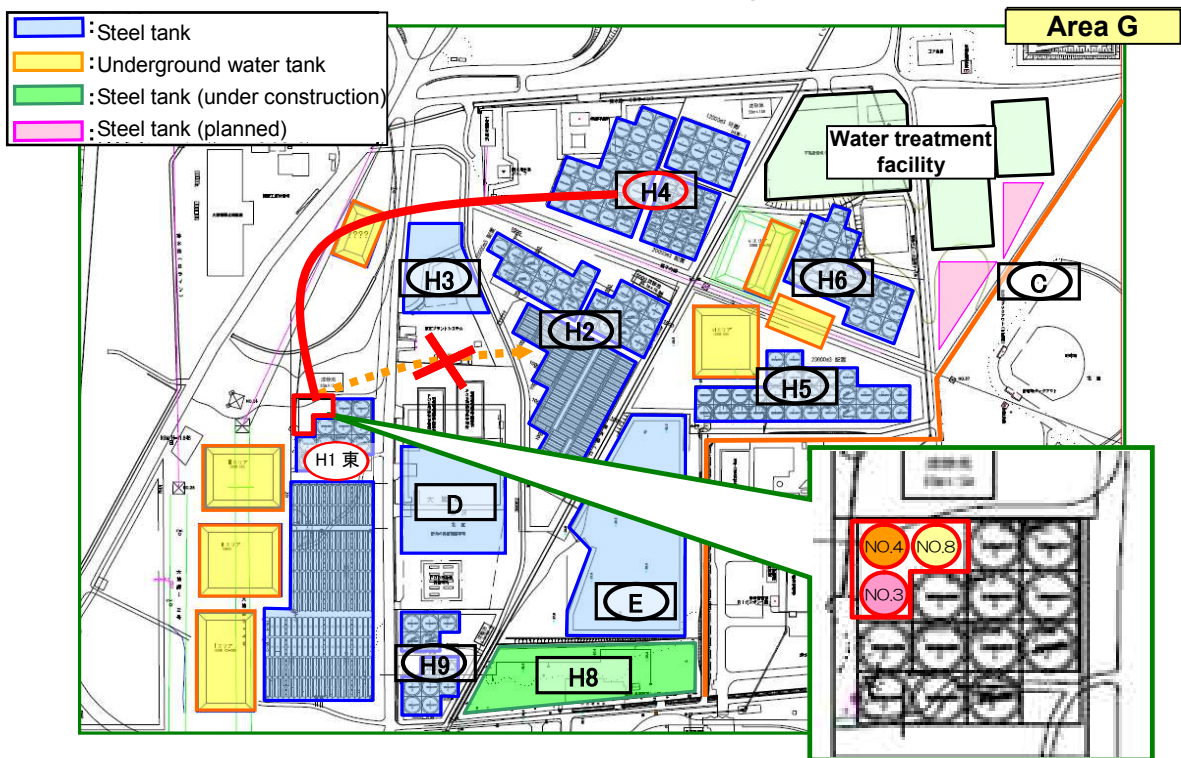


Fig. 1 Locations of tank areas and drainage ditches



Fig. 2 Condition of the foundation in area H1 east

Assessment of the Amount of Leakage from Tanks

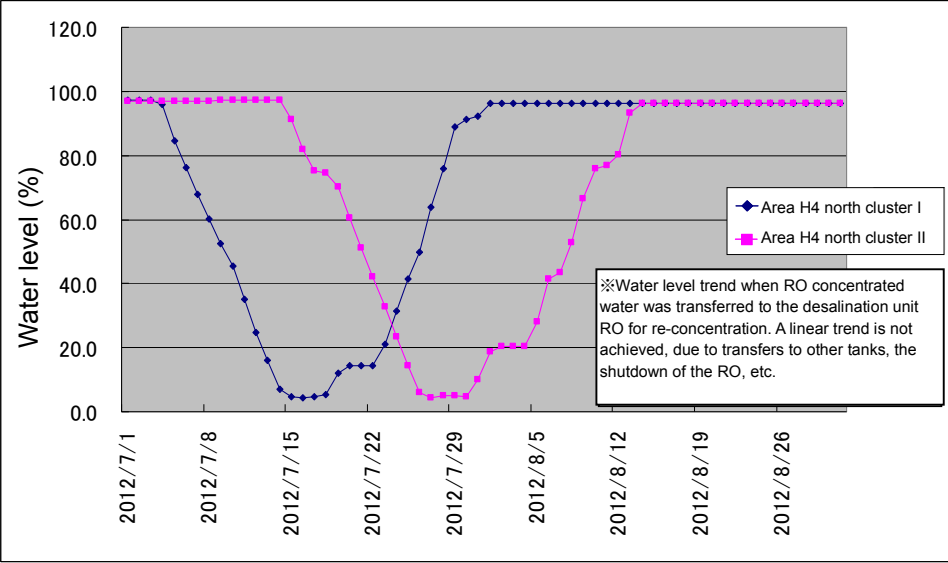


Fig. 1 Water level trends of tanks in area H4 north

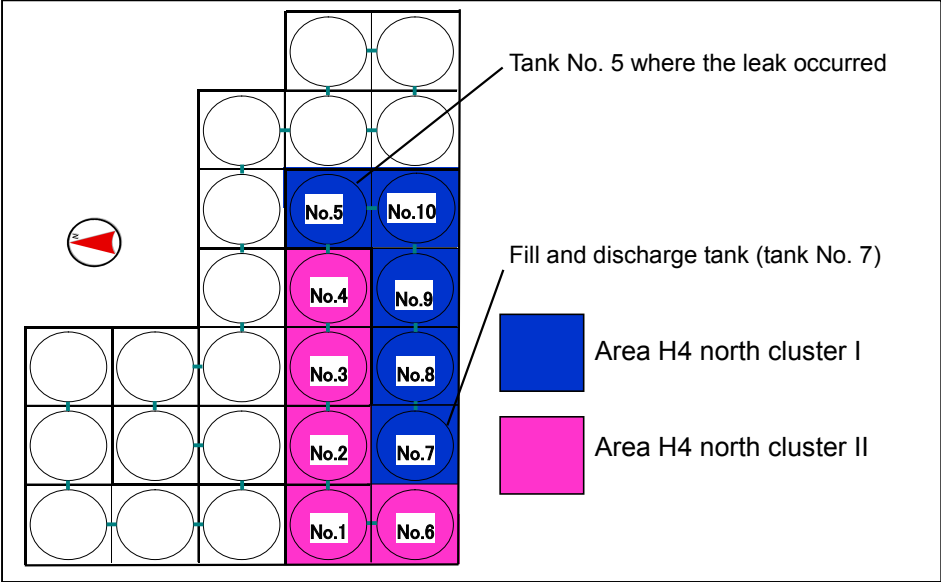


Fig. 2 Arrangement of tanks in area H4 north

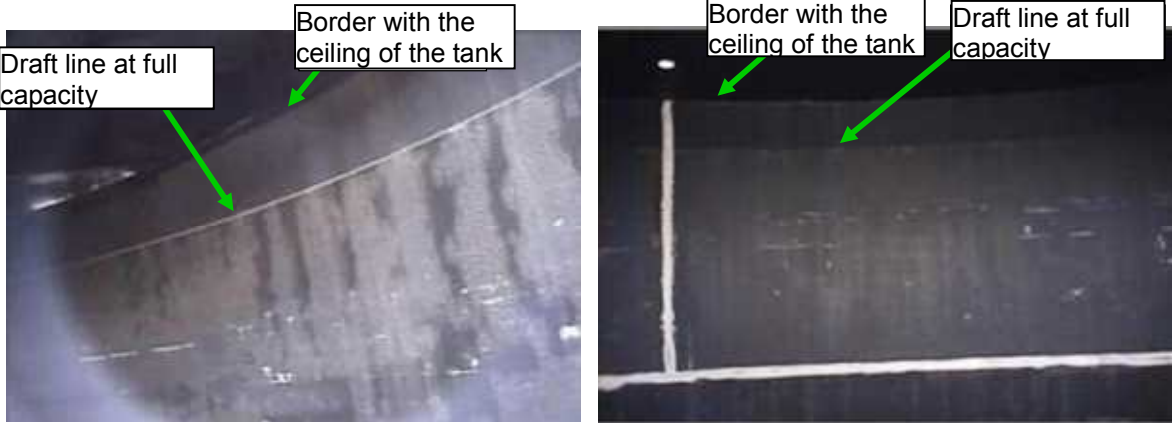


Fig. 3 Draft line inside tank No. 5



## Leaked Amounts of Radioactive Material from the Tank Concerned

- The results of a nuclide analysis of water in tank No. 5 and assessment of leakage amount are as shown in the table below. The leaked amounts were obtained by multiplying the leaked volume of 300m<sup>3</sup> to the concentration of each nuclide.
- The leaked volume of Sr-90—which is thought to have the highest concentration and the greatest impact on the environment—was calculated as 4.5E + 13 Bq.
- With regard to other nuclides, the concentration of tritium was high, but fell below 1/50 that of Sr-90, and cesium and other nuclides fell below 1/10 that of tritium.
- There were no large differences between the water in the tank concerned and the leaked water when considering the fact that the analysis results of the leaked water also show measurement fluctuations and do not necessarily indicate a completely uniform state of radioactive material in the water.

Table 1 Concentration of radioactive material and the amount of leaked water from tank No. 5 in area H4

Nuclide	Water in tank No. 5 (sampled on Aug. 23, 2013, 9:00 p.m.)		[Ref] Leaked water (collected from the dike) (sampled on Aug. 19, 2013, 4:00 p.m.)	
	Concentration (Bq/cm <sup>3</sup> )	Leaked amount (Bq)	Concentration (Bq/cm <sup>3</sup> )	Leaked amount (Bq)
Cs-134	4.4E+01	1.3E+10	4.6E+01	1.4E+10
Cs-137	9.2E+01	2.8E+10	1.0E+02	3.0E+10
Co-60	ND(3.8E+00)	1.1E+09	1.2E+00	3.6E+08
Mn-54	ND(5.2E+00)	1.6E+09	1.9.E+00	5.7E+08
Sb-125	5.3E+01	1.6E+10	7.1E+01	2.1E+10
Sr-90	1.5E+05	4.5E+13	—	—
H-3	2.4E+03	7.2E+11	2.1E+03	6.3E+11
Gross $\beta$	4.1E+05	1.2E+14	2.8E+05	8.4E+13

Note: Of the amount of leaked water from tank No. 5, the amounts of Co-60 and Mn-54 were obtained using the lower measurable limit of detection.

## Boring Survey Results

### 1. Shallow boring survey (Survey <C>)

- At locations C-1, C-2, C-3 and C-4 on the northeast side of the tanks in area H4 where contaminated water has leaked, soil was contaminated with a high concentration of radioactive material. Not only cesium, but gross  $\beta$  radiation concentrations were also high, as the impact of the contaminated water.
- At location C-3 far from the dike, gross  $\beta$  radiation concentrations were low compared to locations C-1 and C-2 near the dike, indicating that a relatively small amount of contaminated water reached that distance.
- On the other hand, at locations C-5 and C-6 on the southeast side of the dike, the ground surface showed a high concentration, but the concentrations of cesium and gross  $\beta$  radiation were about the same, probably as a result of the cesium  $\beta$  dose that adhered near the ground surface after the accident.

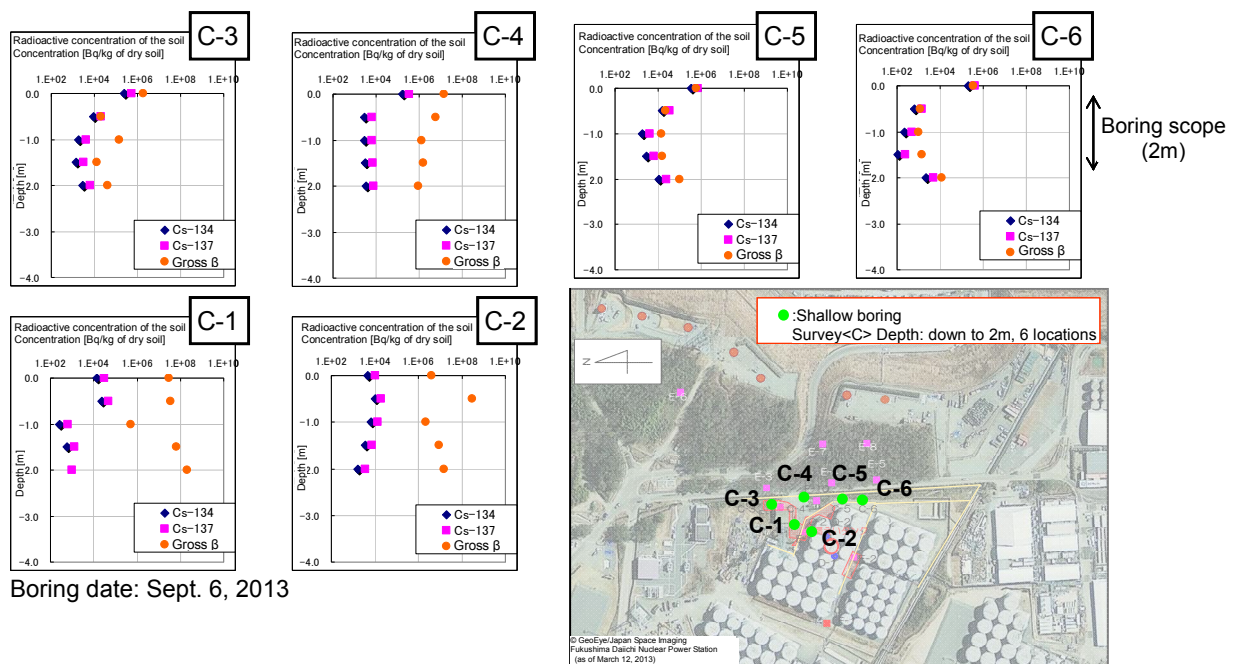


Fig. 1 Results of a shallow boring survey

2. Boring survey directly under the leaking tank

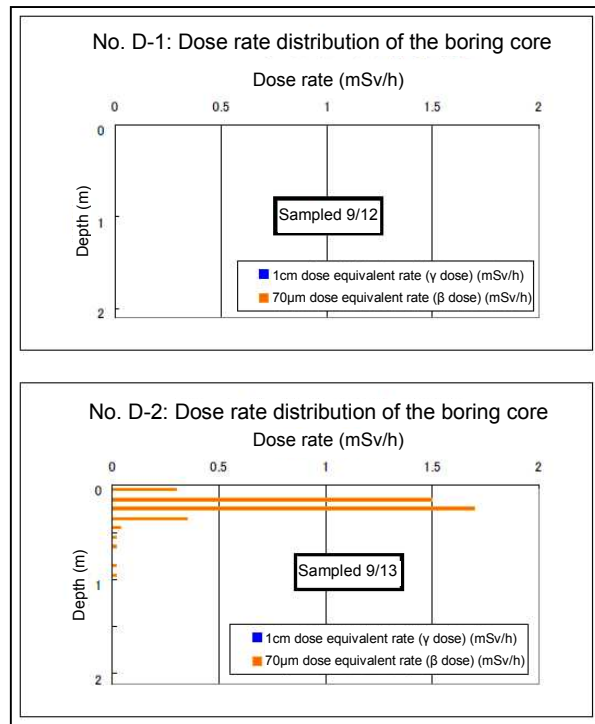


Fig. 1 Results of a boring survey directly under the leaking tank (measurement of dose equivalent rate)

- From location D-2 on the northeast side directly under the leaking tank, a concentration of gross β radiation close to that at location C-2 immediately next to the dike was detected.
- On the other hand, at location D-1 on the southwest side, gross β radiation concentration was low and around the same level as cesium, so the gross β radiation is thought to have come from the cesium that adhered to near the ground surface after the accident.
- From the above, it is thought that contaminated water flowed out from the dike to the northeast side, and some of the contaminated water that seeped into the ground flowed beneath the concrete foundation and reached near location D-2.
- The soil beneath the concrete foundation had been improved (stirred) down to a depth of 1m at the time the ground was developed in the tank area. It is thought that this made the cesium concentration almost uniform in the depth direction.

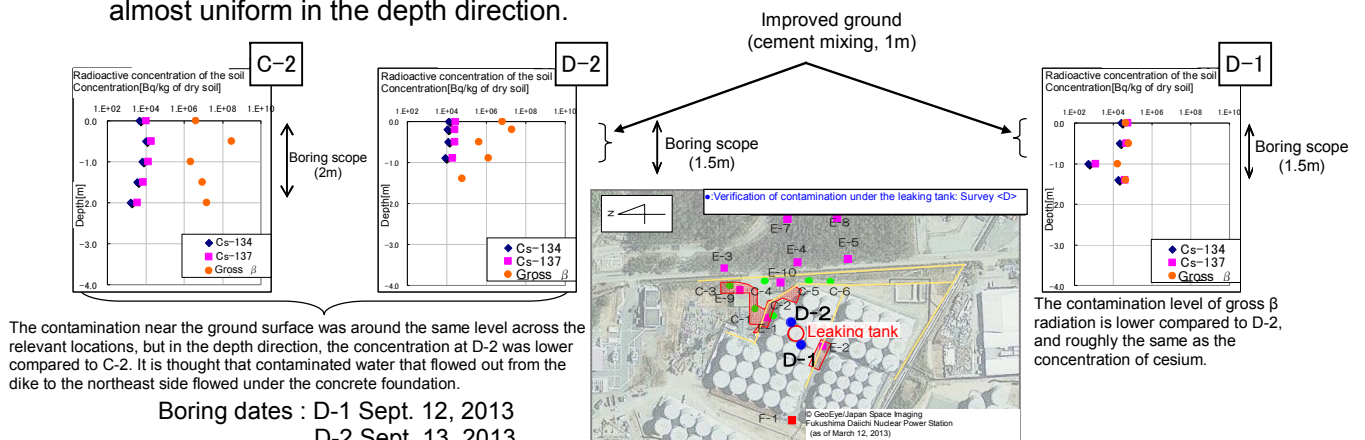
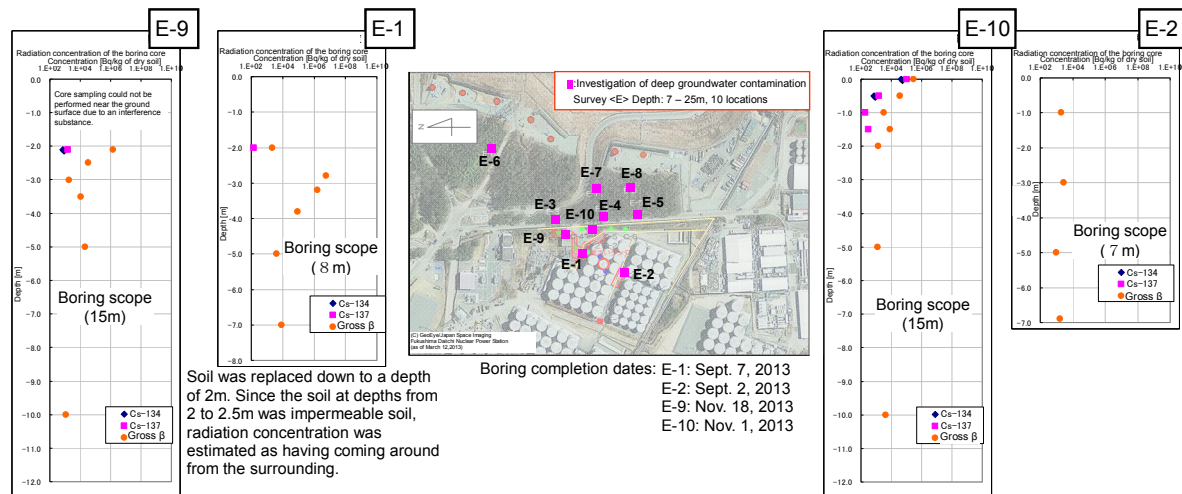


Fig. 2 Results of the boring survey under the leaking tank (nuclide analysis)

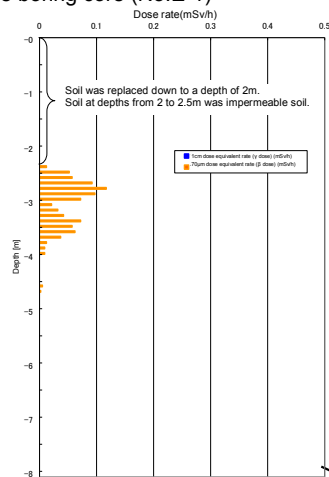
### 3. Boring core survey for investigation of deep groundwater contamination

- At locations E-1 and E-9 on the northeast side of the tanks in area H4, high concentrations of gross  $\beta$  radiation were detected. Particularly at E-1 near the tank area, a high concentration was detected even at a depth of 3m.
- At location E-2 on the south side, gross  $\beta$  radiation was detected, but at a low concentration.
- At location E-10 on the east side, contamination was observed near the ground surface, but there was no large difference with the concentration of cesium.
- At locations E-3 to E-5 on the east side of drainage ditch B, surface dose equivalent rate was measured with the result that no radiation dose was measured, when excluding the ground surface that is thought to have been affected by the cesium that adhered near the ground surface after the accident.

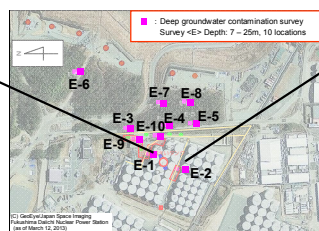
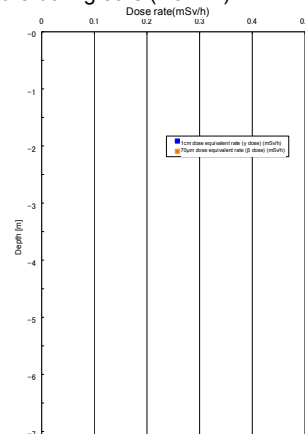


**Fig. 1 Survey of contamination of the boring core for investigation of deep groundwater contamination (E-1, 2, 9, 10)**

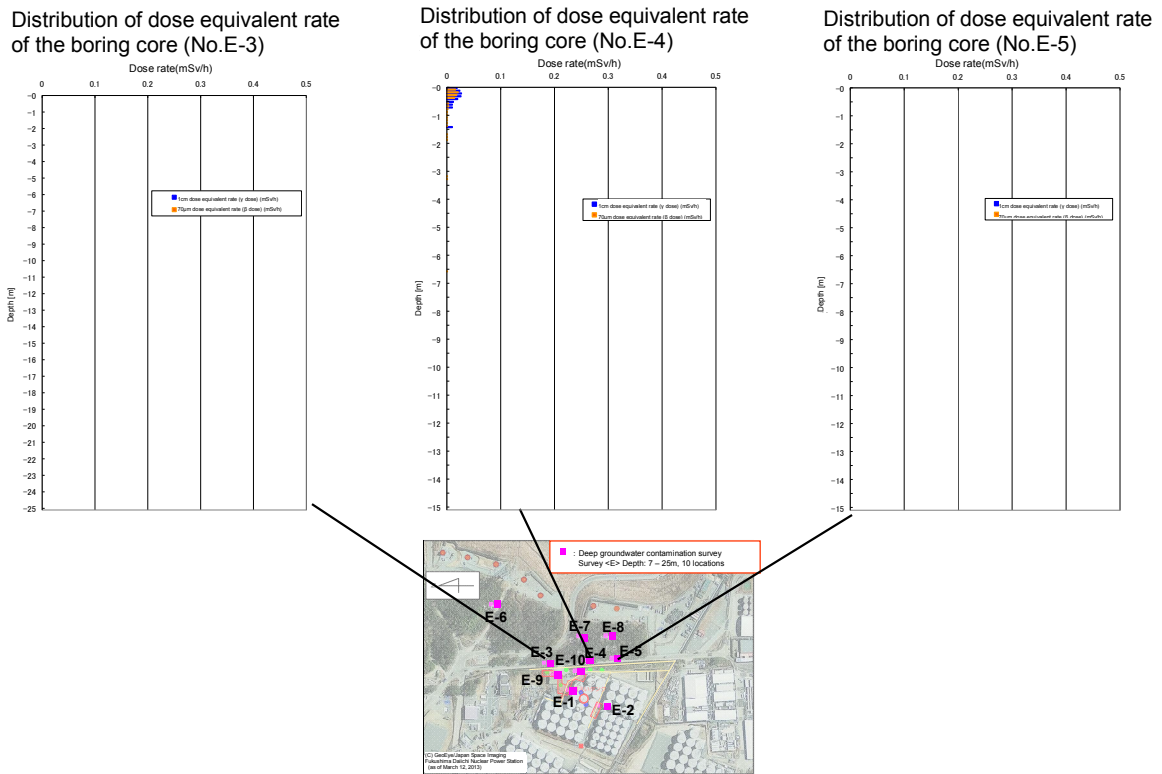
Distribution of dose equivalent rate of the boring core (No.E-1)



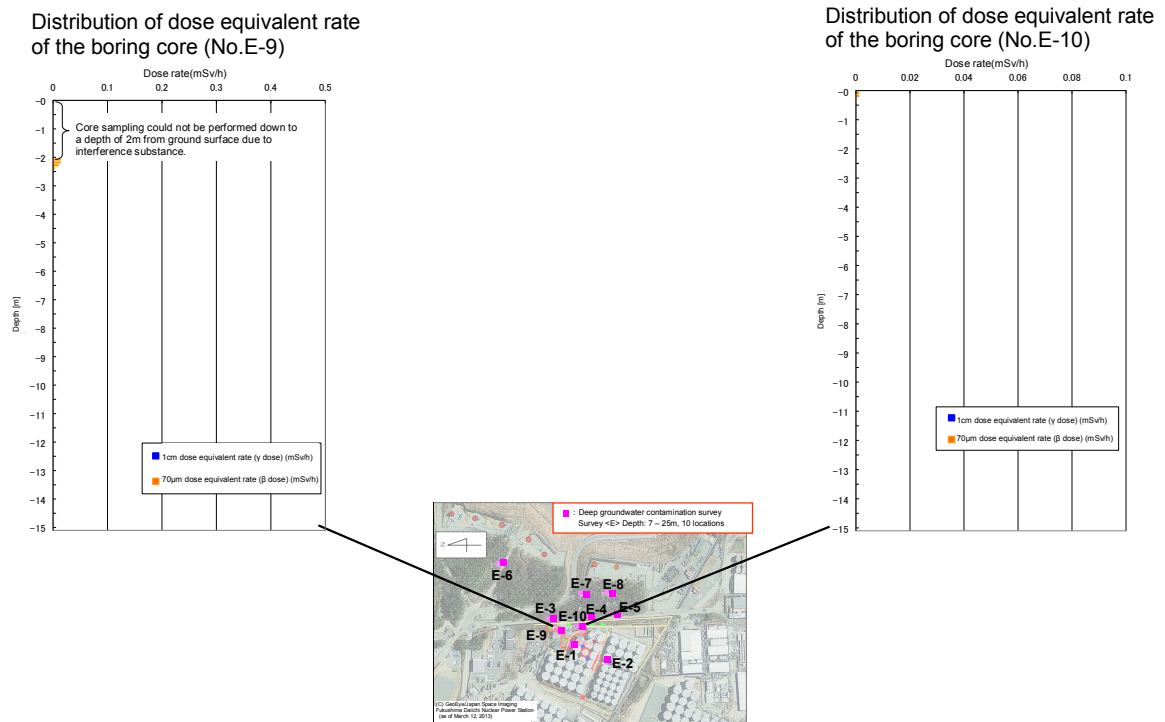
Distribution of dose equivalent rate of the boring core (No.E-2)



**Fig. 2 Survey of dose equivalent rate of the boring core for investigation of deep groundwater contamination (E-1, 2)**

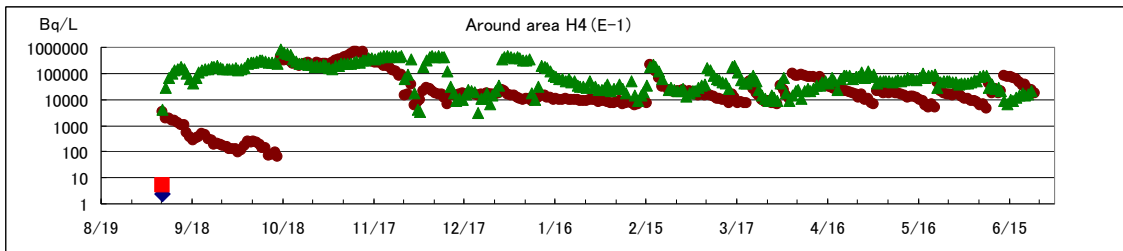


**Fig. 3 Survey of dose equivalent rate of the boring core for investigation of deep groundwater contamination (E-3, 4, 5)**

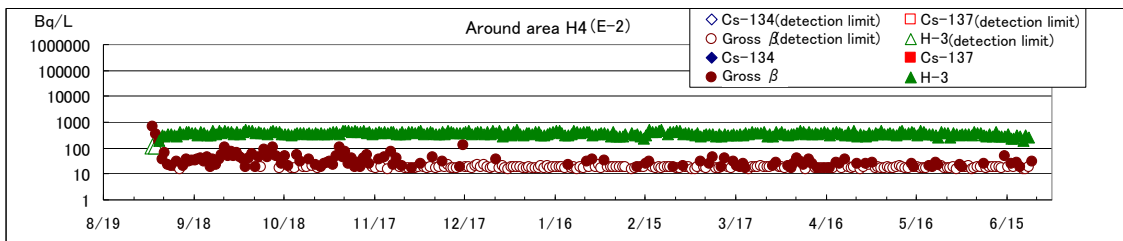


**Fig. 4 Survey of dose equivalent rate of the boring core for investigation of deep groundwater contamination (E-9, 10)**

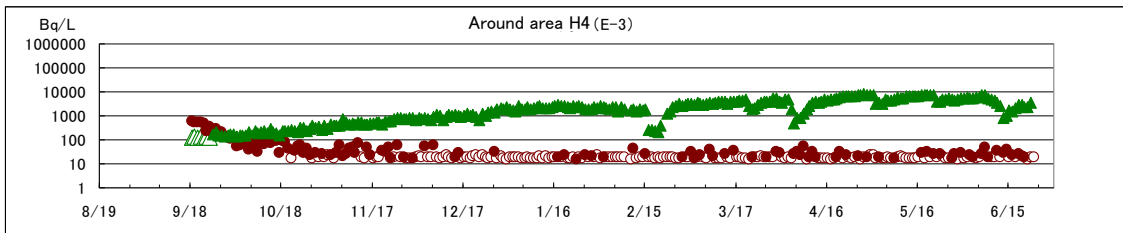
## Results of Deep Groundwater Contamination Investigation



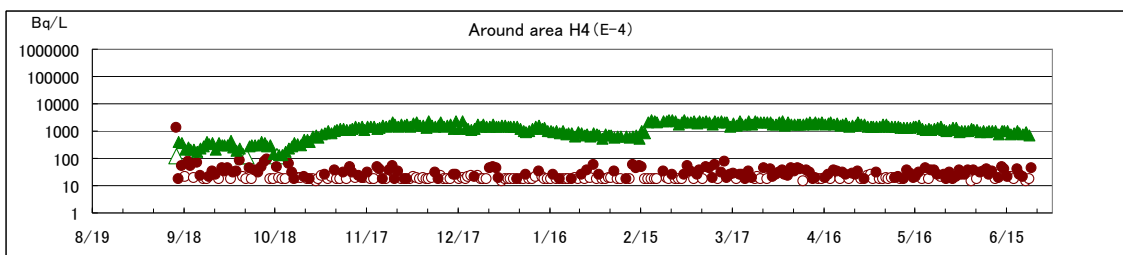
**Fig. 1 Results of boring (E-1) radioactivity analysis**



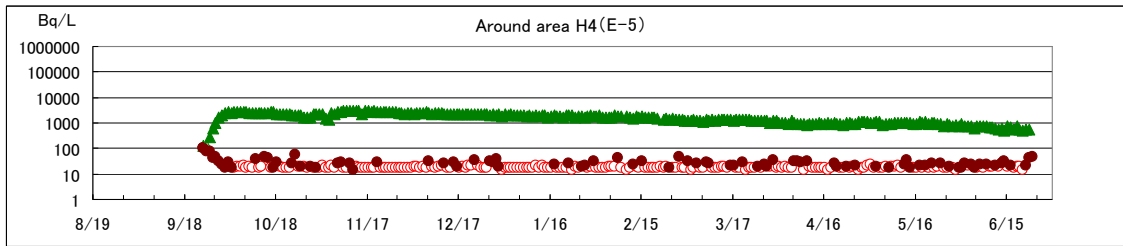
**Fig. 2 Results of boring (E-2) radioactivity analysis**



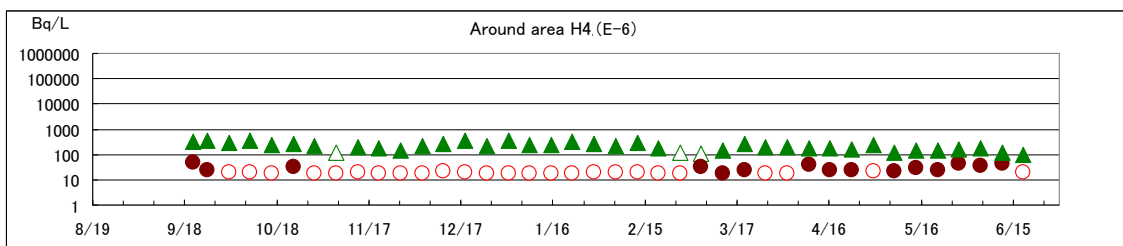
**Fig. 3 Results of boring (E-3) radioactivity analysis**



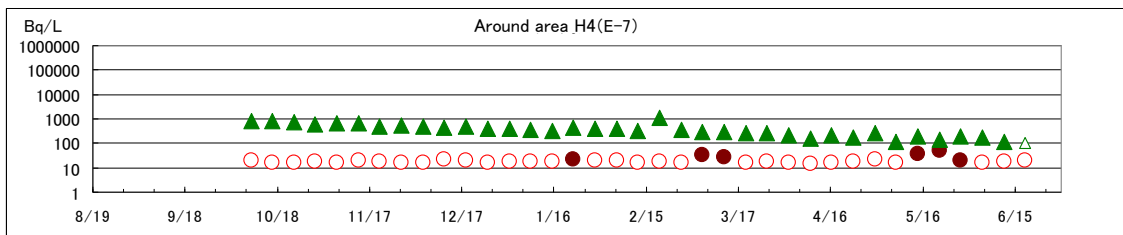
**Fig. 4 Results of boring (E-4) radioactivity analysis**



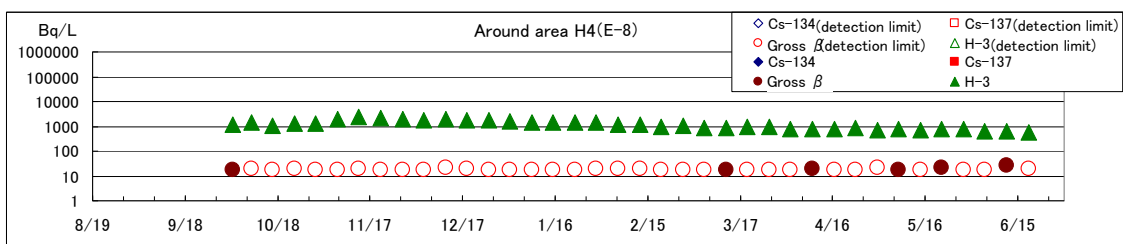
**Fig. 5 Results of boring (E-5) radioactivity analysis**



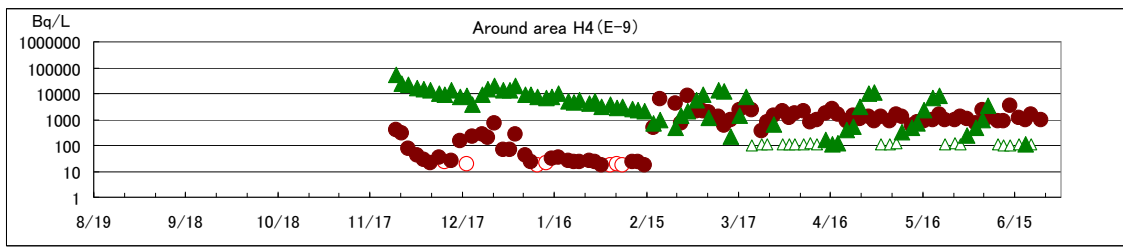
**Fig. 6 Results of boring (E-6) radioactivity analysis**



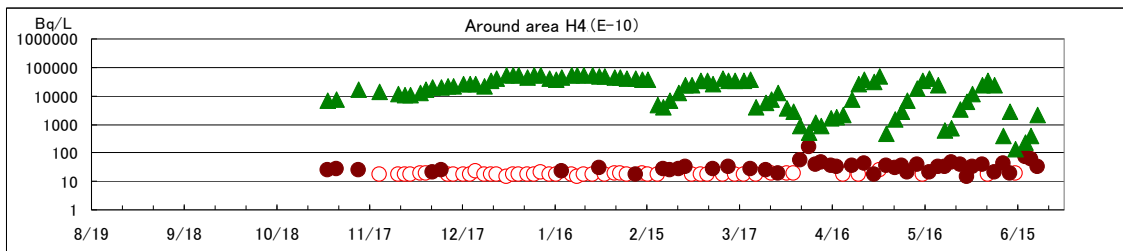
**Fig. 7 Results of boring (E-7) radioactivity analysis**



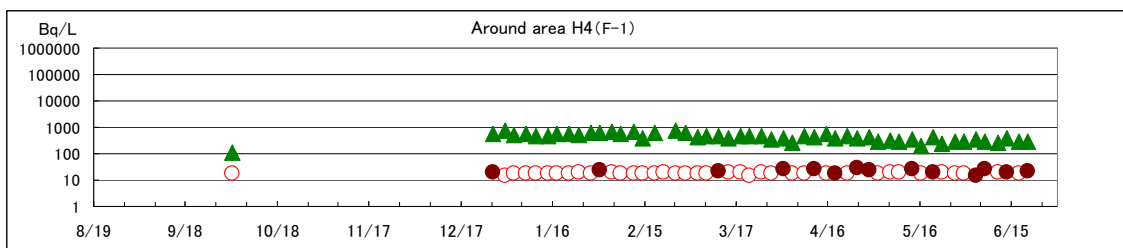
**Fig. 8 Results of boring (E-8) radioactivity analysis**



**Fig. 9 Results of boring (E-9) radioactivity analysis**



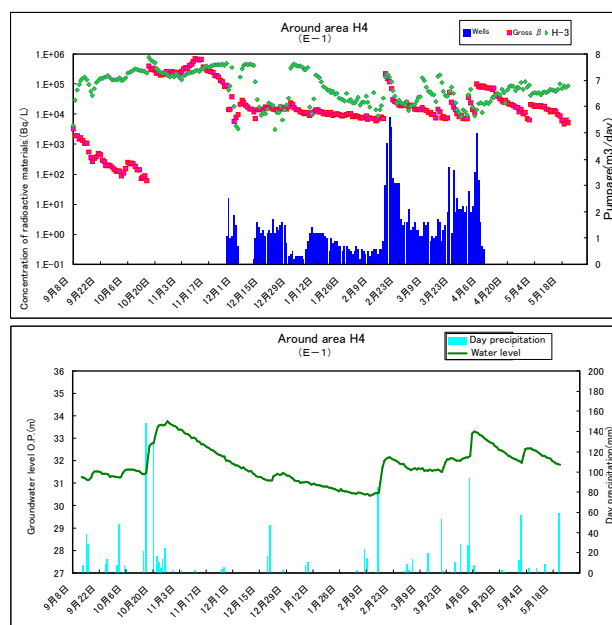
**Fig. 10 Results of boring (E-10) radioactivity analysis**



**Fig. 11 Results of boring (F-1) radioactivity analysis**

(Relationship between Concentrations at E-1 and Rainfall)

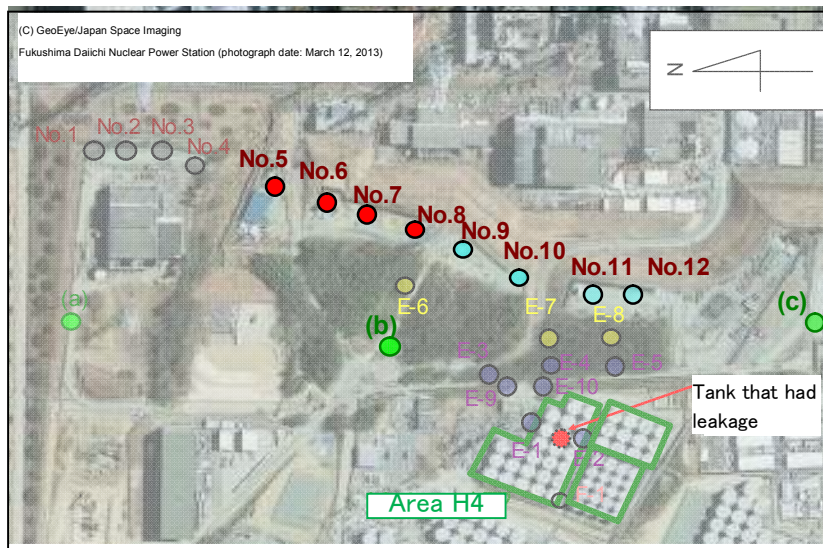
- There is an apparent tendency with regard to groundwater at E-1 for gross beta concentrations in particular to rise when the level of the groundwater rises due to rainfall.
- Radioactive materials remaining below the concrete foundations (thought to be mainly strontium-90) are thought to have been transported by rain and groundwaters to flow temporarily into the vicinity of the observation hole.



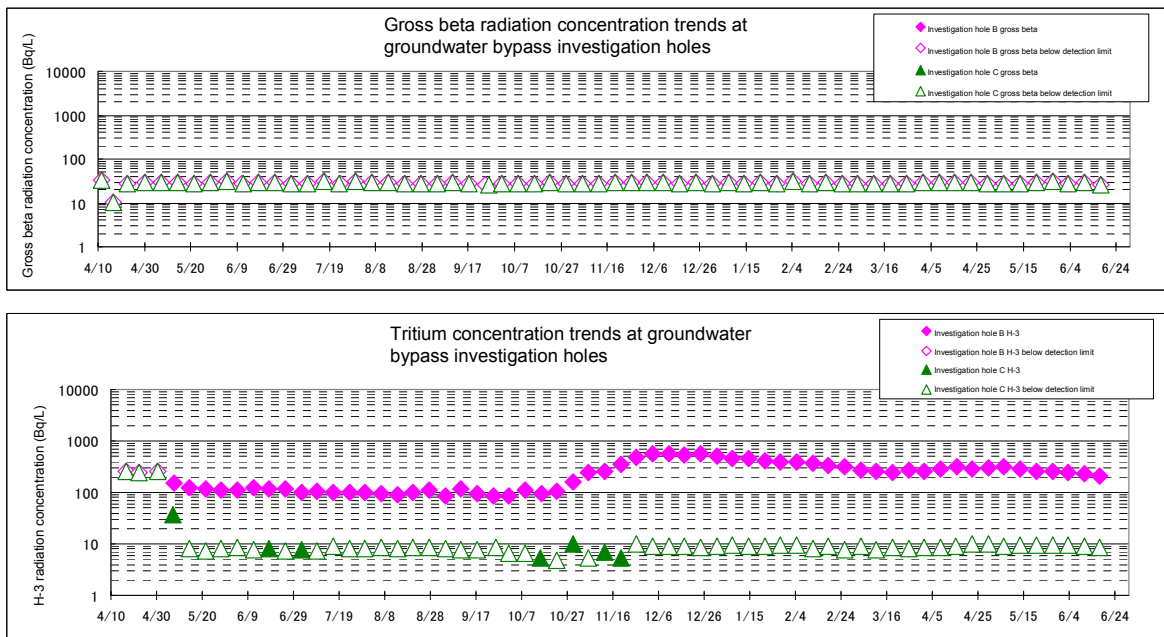
**Fig. 12 Relationship between concentrations at E-1 and rainfall**



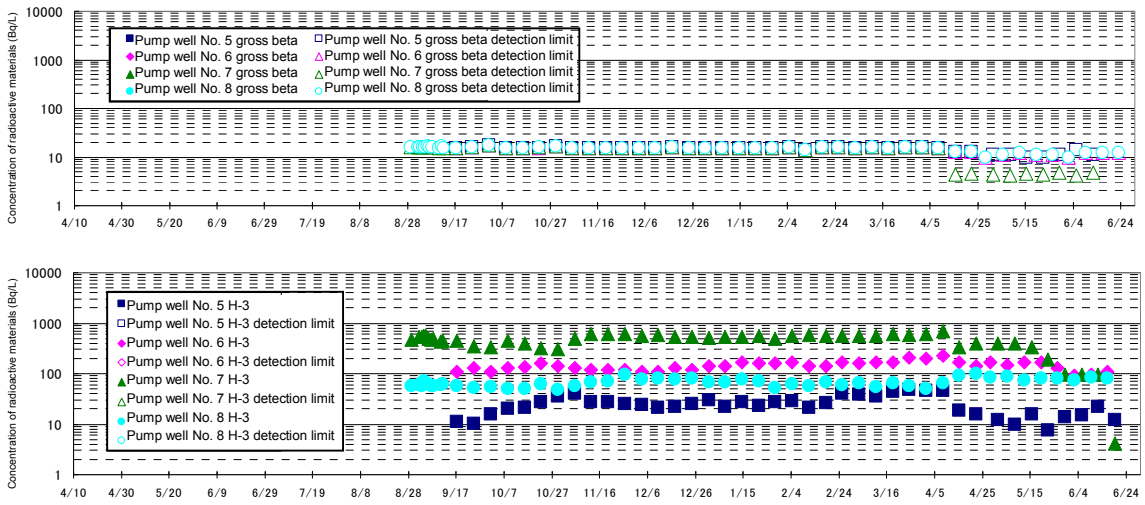
## Results of Investigation and Evaluation of Impact on Groundwater Bypass



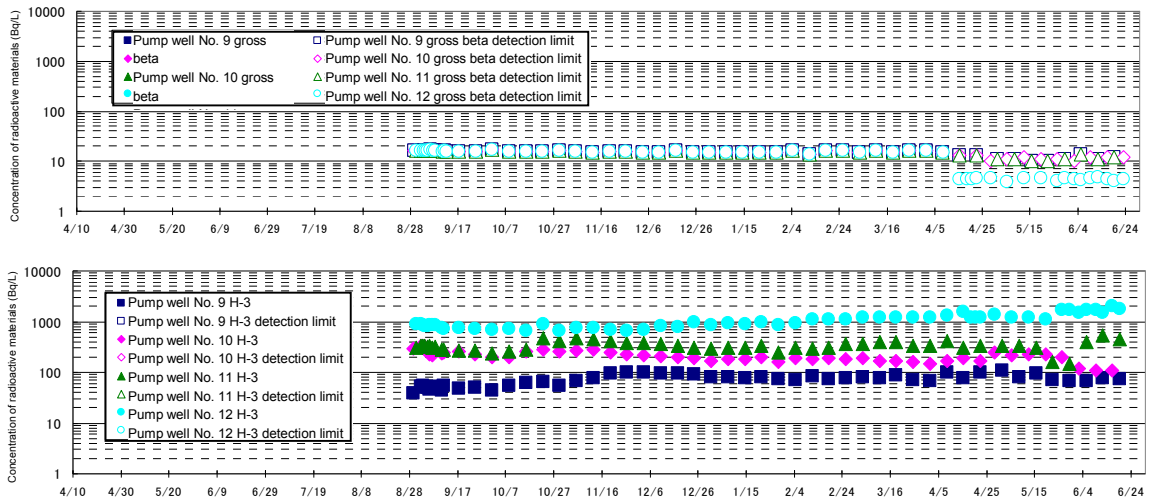
**Fig. 1** Locations of groundwater bypass investigation holes and pump wells for sampling



**Fig. 2** Results of analyses from groundwater investigation holes (b) and (c)



**Fig. 3 Results of groundwater pump well analyses (Nos. 5-8)**



**Fig. 4 Results of groundwater pump well analyses (Nos. 9-12)**

## Assessment of Amount of Radioactive Materials Collected

### 1. Summary of evaluation method

Because the leaked water contains large amounts of strontium-90—a beta nuclide with a significant environmental impact—an attempt was made to assess the amount of strontium-90 collected. However, given the difficulties under present conditions of conducting a strontium analysis of the soil, the amount of leaked strontium-90 collected was estimated according to the following procedures using the gross beta radiation concentration as an index.

- Extrapolating from the soil surface dosage rate as measured on site at time of collection, the gross beta radiation concentrations in the soil at the measurement points were estimated for each block and each depth.
- The average of gross beta radiation concentrations 1 and 2 from above and below the collected soil was taken as the average concentration of the collected soil.
- The product of the amount of soil collected and average concentration for each block and each depth collected was calculated. The total was taken as the total amount of gross beta radioactive materials collected (in Bq), half of which was taken to be the amount of strontium-90 collected.

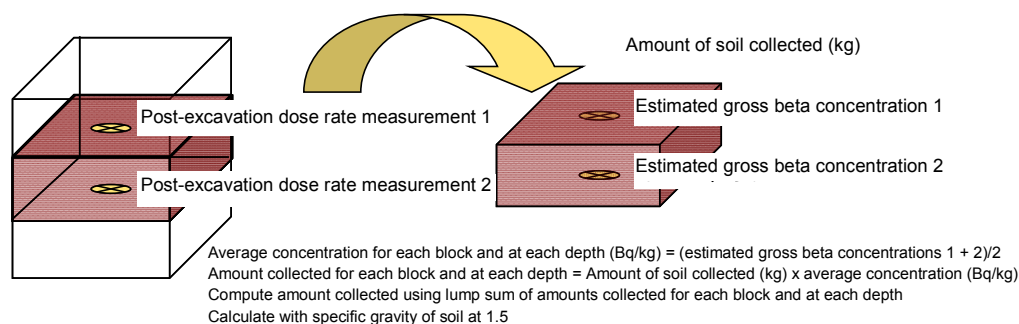


Fig. 1 Estimation technique for collected amount of radioactive materials leaked, based on soil collected

### 2. Relationship between Soil Surface Dosage Rate Measurements and Gross Beta Radiation Concentration

- The gross beta radiation concentration in the boring cores sampled around area H4 was measured. Based on its relationship with the results of the dosage rate measurements, the conversion factor for estimating the gross beta radiation concentration in the collected soil was determined to be  $3.0 \times 10^7$  ((Bq/kg)/(mSv/h)).
- Given that it was not possible to exclude the effects of an undercount owing to dilution difficulties in measuring the soil's gross beta radiation concentration, adjustments were made to the measurement results using a theoretical formula.

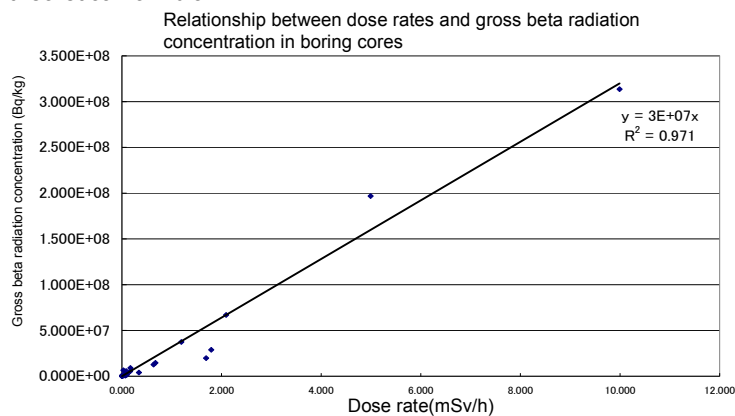


Fig. 2 Gross beta radiation concentration estimates based on soil surface dosage rates

### 3. Estimated amounts collected for each block

- Estimated amounts collected for each block are as bellow. Total of the collected amounts is  $7.4E+13$ Bq for the gross beta radiation.

Table 1: Estimates for amounts of radioactive materials (gross beta radiation) collected for each block

Block	Excavation depth	Post-excavation ground surface 70 $\mu$ m dosage rate (beta) (mSv/h)	Amount of soil collected (m <sup>3</sup> )	Estimated amount collected based on gross beta (Bq)	
1	G.L.-3,000	0.009	60	5.0E+12	
2	G.L.-3,000	0.009	96	9.6E+12	
3	G.L.-3,000	0.009	64	1.4E+12	
9	G.L.-1,080	0.005	16	5.2E+11	
10	G.L.-1,480	0.008	24	3.4E+12	
11	G.L.-840	0.008	15	6.4E+12	
12	G.L.-860	0.008	16	6.6E+12	
13	G.L.-550	0.009	10	5.6E+12	
14	G.L.-400	0.006	3	1.0E+12	
15	G.L.-1,050	0.009	17	1.0E+11	
16	G.L.-900	0.004	21	1.9E+11	
17	G.L.-600	0.006	10	1.8E+11	
18	G.L.-600	0.007	15	2.2E+11	
19	G.L.-700	0.004	18	3.9E+11	
20	G.L.-600	0.006	21	3.7E+11	
21	G.L.-600	0.008	3	3.7E+10	
22	G.L.-900	0.005	7	3.5E+12	
23	G.L.-900	0.008	3	1.7E+12	
24	G.L.-1,650	0.35	3	2.3E+12	
25	G.L.-1,000	0.34	9	2.4E+12	
26	G.L.-1,000	0.35	6	1.5E+12	
27	G.L.-1,000	0.007	29	6.6E+11	
28	G.L.-2,500	0.04	26	2.5E+11	
29	G.L.-2,500	0.1	17	4.5E+11	
30	G.L.-1,000	0.008	18	1.2E+12	
31	G.L.-2,500	0.11	23	7.2E+11	
32	G.L.-3,000	0.007	30	2.0E+12	
33	G.L.-3,000	0.13	10	7.0E+11	
34	G.L.-1,500	0.006	6	4.1E+11	
35-1	G.L.-2,000	13	10	3.9E+12	
35-2	G.L.-2,000	1.7	9	2.2E+12	
36	G.L.-2,000	0.8	19	3.0E+12	
37	G.L.-2,000	2.2	15	2.6E+12	
38	G.L.-800	0.006	25	7.2E+11	
39	G.L.-1,000	0.008	27	6.2E+11	
40	G.L.-1,600	0.008	16	7.6E+10	
40-1	G.L.-1,800	0.007	16	7.6E+10	
41	G.L.-1,500	0.008	24	4.4E+11	
42	G.L.-1,300	0.009	31	5.7E+11	
43	G.L.-1,500	0.008	19	1.3E+11	
44	G.L.-1,500	0.007	32	5.8E+11	
45	G.L.-1,500	0.005	39	2.7E+11	
Total				878	7.4E+13

Note: Blocks 4 through 8 are missing because the soil that was collected included soil collected from surrounding blocks.

### 4. Regarding amounts of radioactive materials leaked from tank

- The results of a nuclide analysis of the water from tank No. 5 and an assessment of the amounts leaked are shown on the below table. The leaked volume of 300 m<sup>3</sup> was multiplied against the concentrations of each nuclide to obtain the amounts leaked.
- The leaked volume of strontium-90, which had the highest concentrations and is thought to have the greatest environmental impact, was calculated to be  $4.5E+13$  Bq.
- Among the other nuclides the concentration of tritium was also high, but it was less than 1/50 that of strontium-90. Those of cesium and other nuclides were a further 1/10 of that.
- Also, no major differences were seen with the results of the analysis of leaked water collected inside the dike.

Table 2: Concentrations of radioactive materials in water leaked and leakage amount from area H4 No. 5 tank

Nuclide	No. 5 tank water		[Remarks] Leaked water (collected from inside dike)	
	Concentration (Bq/cm <sup>3</sup> )	Leakage amount (Bq)	Concentration (Bq/cm <sup>3</sup> )	Leakage amount (Bq)
Cs-134	4.4E+01	1.3E+10	4.6E+01	1.4E+10
Cs-137	9.2E+01	2.8E+10	1.0E+02	3.0E+10
Co-60	ND(3.8E+00)	1.1E+09	1.2E+00	3.6E+08
Mn-54	ND(5.2E+00)	1.6E+09	1.9E+00	5.7E+08
Sb-125	5.3E+01	1.6E+10	7.1E+01	2.1E+10
Sr-90	1.5E+05	4.5E+13	—	—
H-3	2.4E+03	7.2E+11	2.1E+03	6.3E+11
Gross $\beta$	4.1E+05	1.2E+14	2.8E+05	8.4E+13

Note: The leakage amounts for the Co-60 and Mn-54 present in the water from tank No. 5 were obtained using the lower detection limit.

## 5. Regarding collection rate estimates

- The analysis of the gross beta radiation in the collected soil was conducted several months after collection. The Sr-90 and its daughter nuclide Y-90 are thought to have entered a condition of equilibrium. Given that the concentrations of Cs-134 and Cs-137 in the leaked water were three decimal places lower than that of the Sr-90, the collection rate obtained was around 80% on the assumption that Sr-90 constituted half the  $7.4E+13$  Bq collected from the soil.
- On the other hand, the estimated collection rate based on the gross beta radiation concentration in the tank water and water leaked inside the dike ranged from approximately 60% to 90%. Furthermore, the concentration of nuclides other than gross beta in the leaked water was almost the same as that in the tank water; this was thought to be because it was not diluted by rain water and the like.

Table 3 Estimates for amounts of radioactive materials (gross beta radiation)

Sample name	Water of tank No. 5		[Reference] Leaked water from area H4	Remarks
	Sr-90	[Reference] Gross beta radioactivity	Gross beta radioactivity	
Concentration [Bq/cm <sup>3</sup> ] ...①	1.5E+05	4.1E+05	2.8E+05	
Leakage amount (300 m <sup>3</sup> ) ...②	300	300	300	
Leakage amount (Bq) ...③=①×②	4.5E+13	1.2E+14	8.4E+13	
Amount collected based on soil (Bq) ...④	3.7E+13	7.4E+13	7.4E+13	The amount of Sr-90 collected was half the collected amount as assessed from gross beta.
Collection rates ...⑤=④/③	80%	60%	90%	

## 6. Regarding amounts of materials collected from sources other than soil

- After contaminated water leaked, in addition to collecting soil dirt was also collected when the drainage outlets were cleaned and contaminated water was drawn up from the wellpoints.
- Assessments of the amounts of these various materials collected are shown on the table below. They are quantitatively small compared to amounts collected from the soil, and not of quantities that would have an impact on the assessment of the total amounts collected.

Table 4 Results for leaked radioactive materials collected from sources other than soil

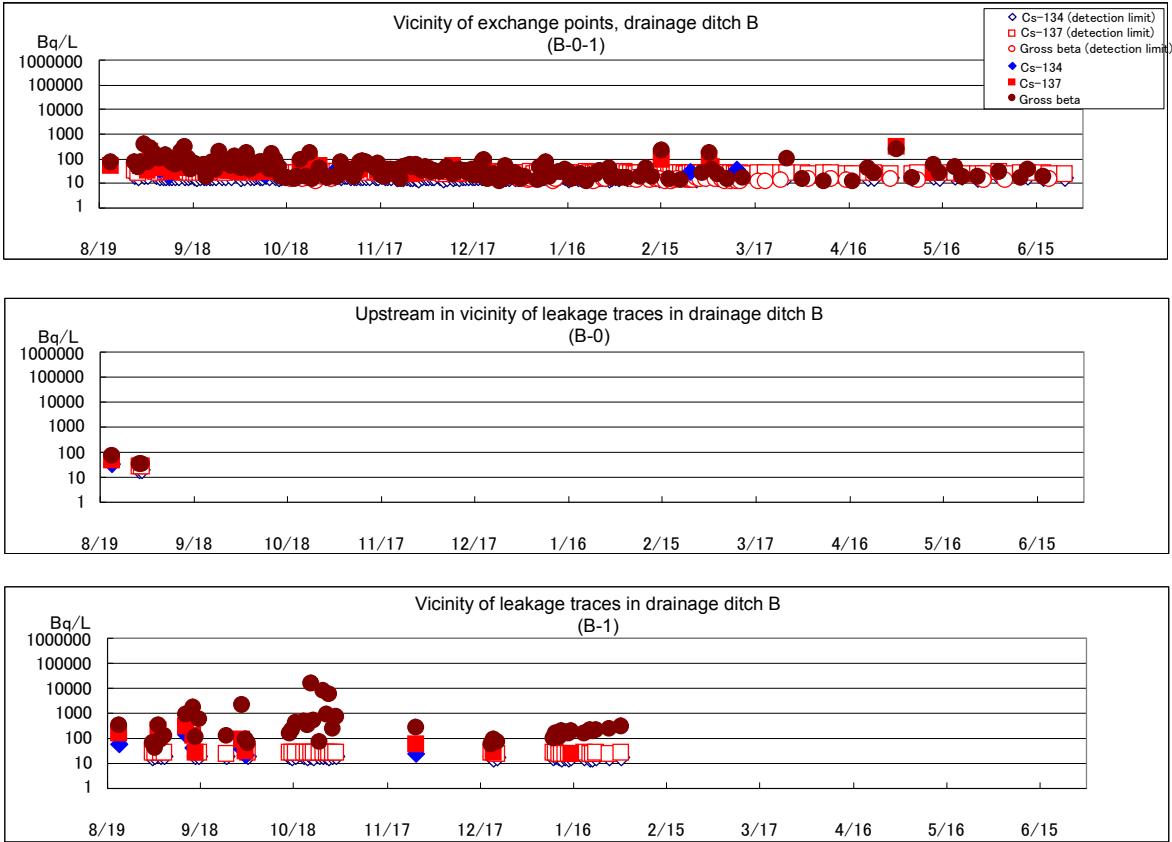
Item	Amount collected (m <sup>3</sup> )	Gross beta radiation concentration		Amount of radioactivity collected (gross beta) (Bq)	Remarks
Dirt collected from drainage ditch B	27	7.8E+05	Bq/kg	3.2E+10	Maximum value (0.026 mSv/h) from dose rates measured in the drainage ditch dirt was multiplied by the conversion factor for the soil and dose rates to compute concentration (specific gravity of 1.5)
Drawn up from wellpoints (November 26, 2013 to April 8, 2014)	178	5.8E+03~2.2E+05	Bq/L	5.7E+09	The gross beta radiation concentration of the drawn-up groundwater was taken as the concentration for observation hole E-1 from which water was collected that same day. The volumes drawn up day by day were multiplied by the concentration of E-1 to compute the amounts collected.
Total amount collected				3.7E+10	

## Results of Investigations of Drainage Ditches B and C

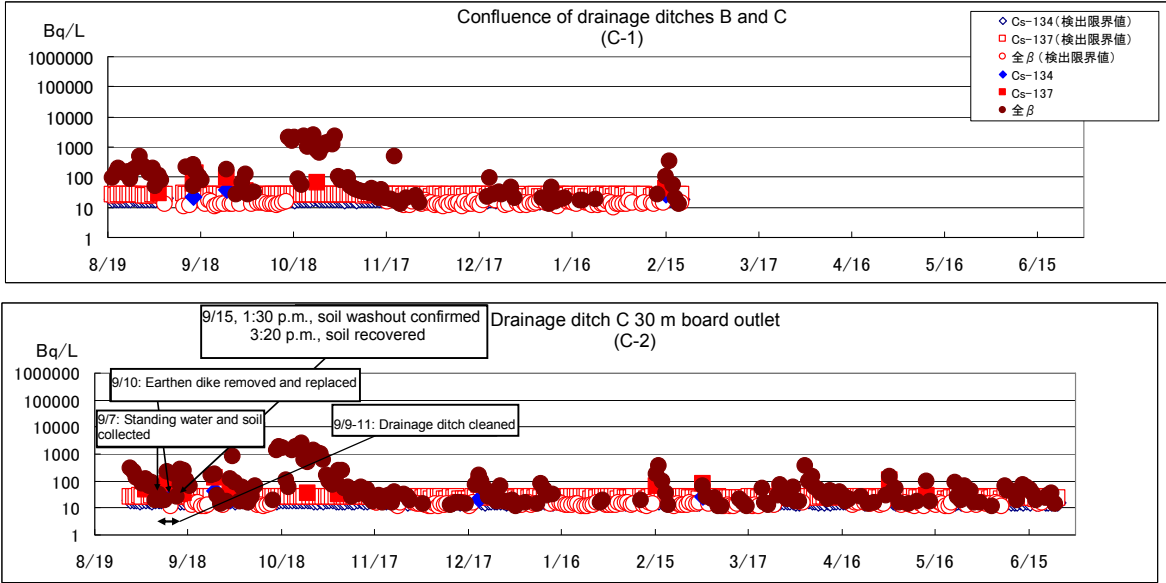


Fig. 1 Points where samples collected from drainage ditches B and C

- Spots were confirmed on the walls of drainage ditch B where high doses of radiation were measured that were thought to be the result of an influx of contaminated water. The dosage rates of the mud in drainage ditch B were measured and a nuclide analysis of the water performed, showing the amounts of beta radiation and gross beta radiation concentration to be high. For these reasons, the drainage ditch was closed off with sandbags, mud and water were collected, and the ditch was cleaned and covered.
- Along with the covering project, measures including raising the height of the dikes in the tank area and building further dams around the area were also taken to prevent any inflows into the drainage ditch.
- The concentrations of radioactive materials in the drainage ditch were reduced thanks to having implemented the aforementioned measures. However, conditions at present are still such that small amounts of contamination are being confirmed when there are rainfalls even including upstream of the tank area.
- Efforts are continuing to improve the environment by decontaminating and laying down facing on the entire grounds.



**Fig. 2 Results of drainage ditch investigations (1/2)**



**Fig. 3 Results of drainage ditch investigations (2/2)**



## Results of Investigations into Impact on Ocean

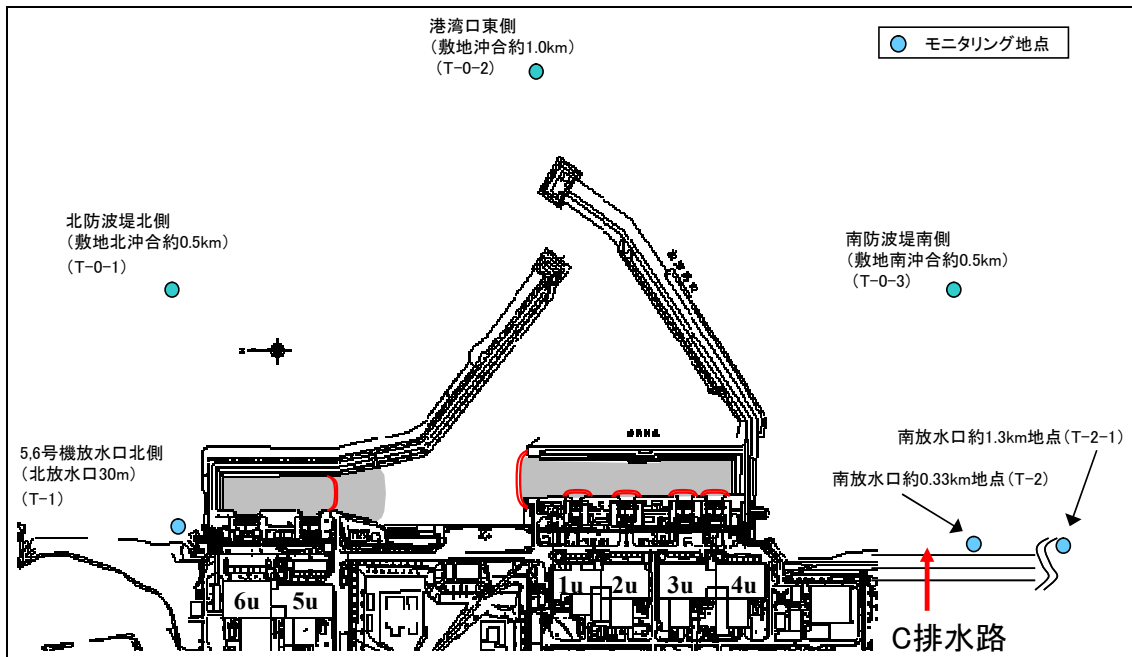
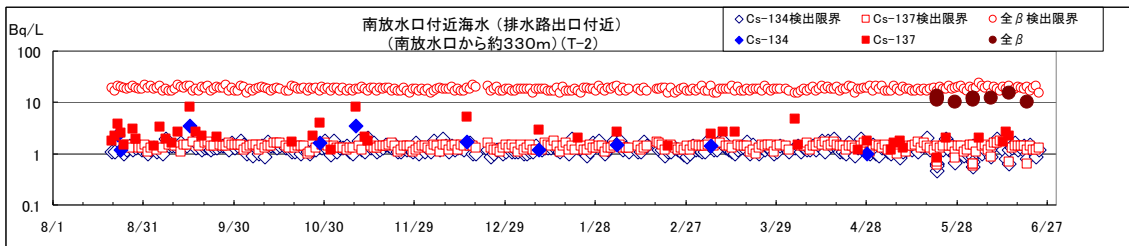
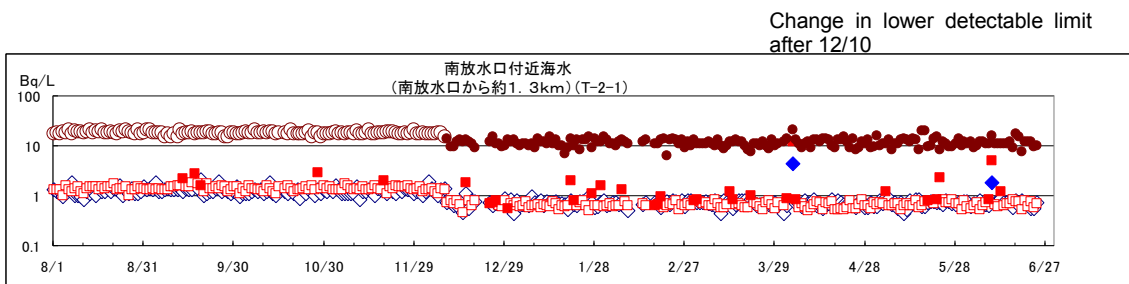


Fig. 1 Ocean monitoring point

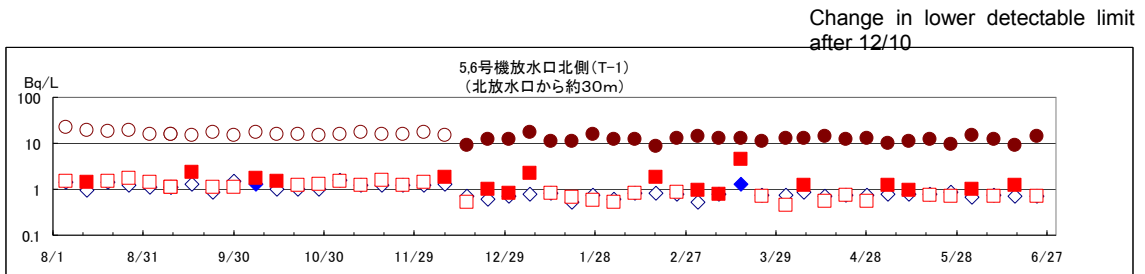
- Highly radioactive locations where leaked water is thought to have flowed along walls of drainage ditch B were confirmed in survey of ground surfaces done after leakage discovered.
- For that reason, drainage ditch B was dammed up with sandbags and the standing water and soil in the ditch were collected.
- Furthermore, facing was put on drainage ditch B and both it and drainage ditch C were covered. Water was allowed to resume flowing in March 2014.
- No rise in gross beta radiation concentrations had been apparent in the results of monitoring conducted on the oceans near the northern and southern wash ports and nearby harbor locations prior to the leakage being discovered.



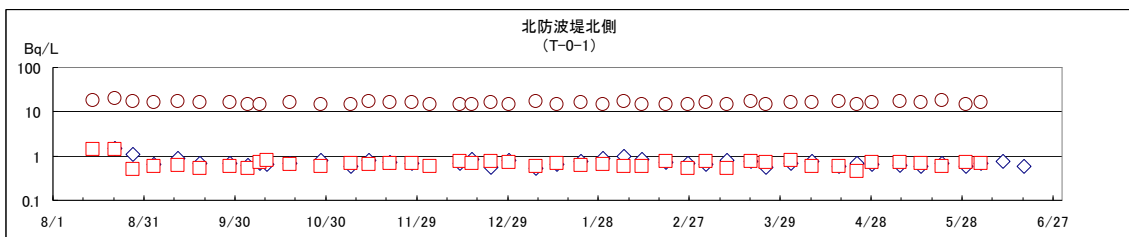
**Fig. 2 Vicinity of southern wash port (point approx. 0.33 km from southern wash port) (T-2)**



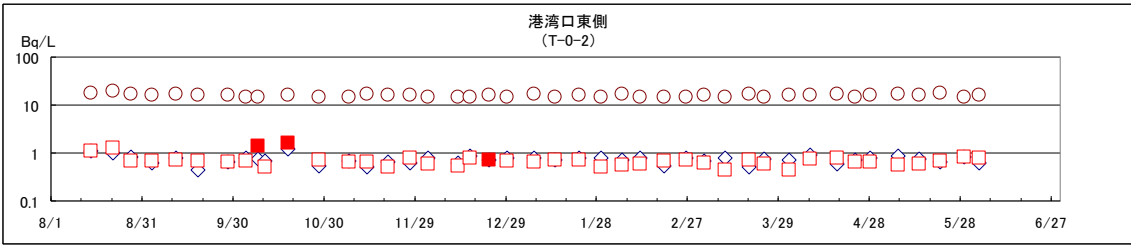
**Fig. 3 Vicinity of southern wash port (point approx. 1.33 km from southern wash port) (T-2-1)**



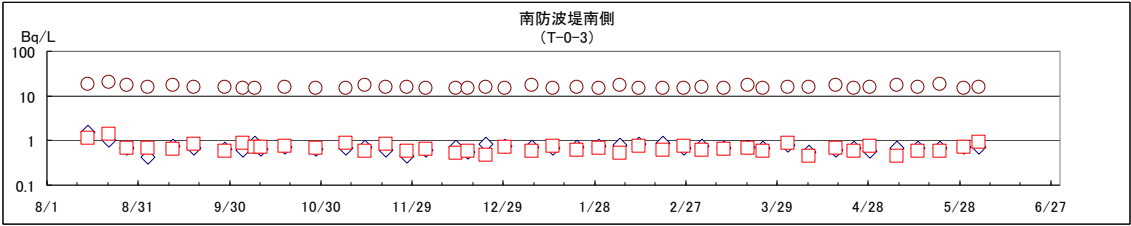
**Fig. 4 North side of wash ports for Units 5 and 6 (T-1)**



**Fig. 5 North of north side breakwater (T-0-1)**



**Fig. 6 East side of harbor entrance (T-0-2)**



**Fig. 7 South of south side breakwater (T-0-3)**

Summary of Investigations into Locations of Tank Leaks (pre-dismantling)

Event		Hypothesized cause	Pre-dismantling investigation		Remarks
			Action taken	Results*1	
Leakage from sideplate	Leakage from base material (welded section)	- Manufacturing defect (welding flaws, etc.) - Corrosion	- Visual check of external appearance (outside)	- No significant leakage confirmed	△  Refer to investigation results (5), (6)
			- Dosage measurement (external)	- Regions with relatively high dosages (approx. 40 mSv/h, 1 location)	
			- Visual check of inner surface	- Rust outbreak confirmed in one spot	
			- Vacuum	- No leakage path confirmed	
Leakage from sideplate	Leakage from flanged section	- Bolt looseness - Sealing damaged/ deteriorating	- Visual check of external appearance (outside)	- No significant leakage confirmed	△  Refer to investigation results (4), (5)
			- Dosage measurement (external)	- No significant regions confirmed	
			- Visual check of external appearance (inside)	- Packing projecting out confirmed	
			- Dosage measurement (inside)	- Around 10 mSv/h for the most part, max of approx. 20 mSv/h <sup>2</sup>	
Leakage from baseplate	Leakage from base material (welded section)	- Manufacturing defect (welding flaws, etc.) - Corrosion	- Bubbling	- No bubbling confirmed	×
			- Vacuum	- No leakage path confirmed	
	Leakage from flanged section	- Bolt looseness - Sealing damaged/ deteriorating	- Bubbling	- No bubbling confirmed	○  Refer to investigation results (1) through (5)
			- Visual check of external appearance (inside)	- Bulging in sealing material present	
			- Bolt tapping	- Looseness in bolts	
			- Dosage measurement	- Around 10 mSv/h for the most part, max of approx. 22 mSv/h <sup>2</sup>	
Leakage from baseplate	Leakage from flanged section	- Bolt looseness - Sealing damaged/ deteriorating	- Vacuum	- Suctioning in of bubbles from 2 bolt locations confirmed	○
			- Localized vacuum	- Bubbling confirmed from same locations as noted above	
Leakage from connecting pipe	Leakage from connecting pipe	- Bolt looseness - Connecting pipe damaged/ deteriorating	- Visual check of external appearance	- No significant leakage confirmed	×
			- Dosage measurement	- No significant regions confirmed	

\*1: ○ - Possible leak location confirmed  
 △ - Possibility of leak location cannot be denied  
 × - Not a leak location  
 \*2: Beta radiation 70 μm dose equivalent rate

Fig. 1 Summary of Investigations into Locations of Tank Leaks (pre-dismantling)

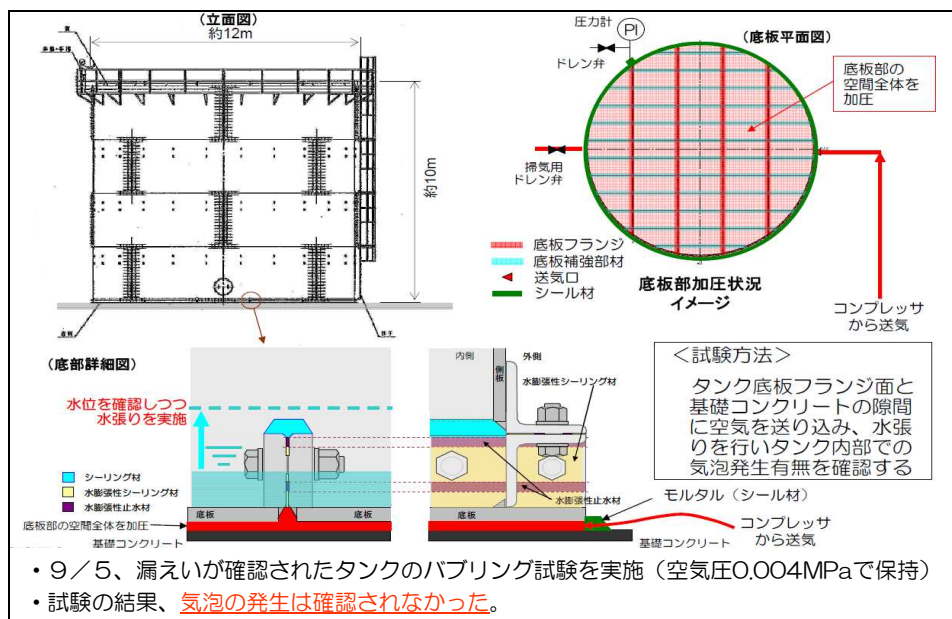


Fig. 2 Investigation Results (1) (baseplate bubbling test results)

- Foam was applied to the baseplate flange sections, etc., and then the bottom part of the baseplate suctioned, confirming that bubbles were suctioned in from 2 adjacent bolts.

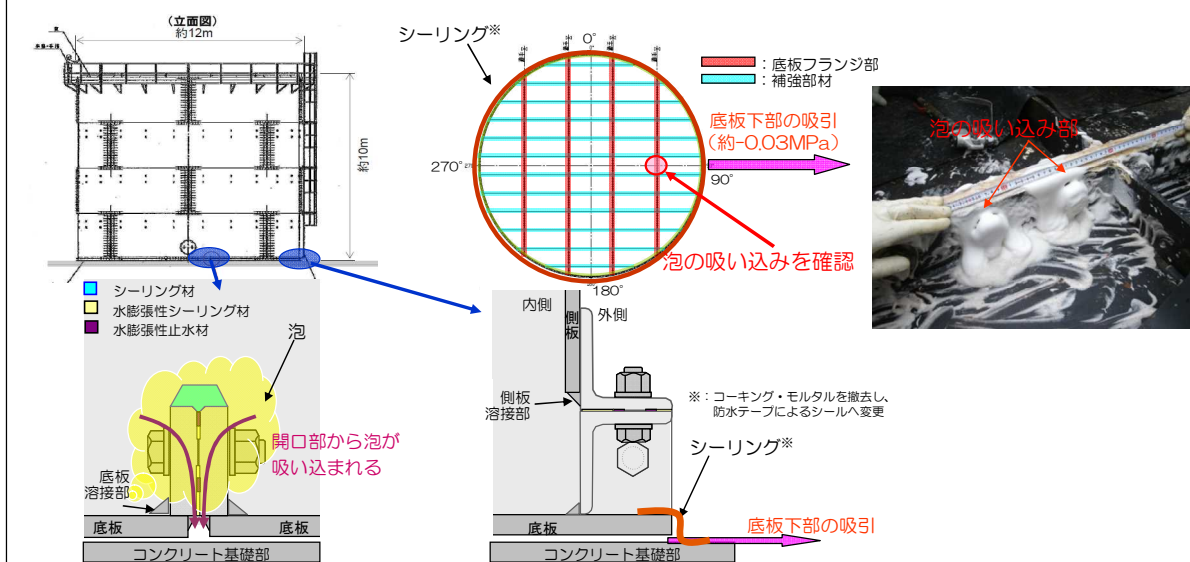


Fig. 3 Investigation Results (2) (vacuum test on baseplate bottom part)

- 底板バキューム試験にて泡が吸い込まれた箇所、ボルトの緩みが確認された箇所、シーリングの膨らみが確認された箇所（代表部）に対し、局所バキューム試験を実施したところ、泡が吸い込まれた箇所から発泡を確認した。また、ボルトの緩み部、シーリングの膨らみ部については、発泡は確認されなかった。

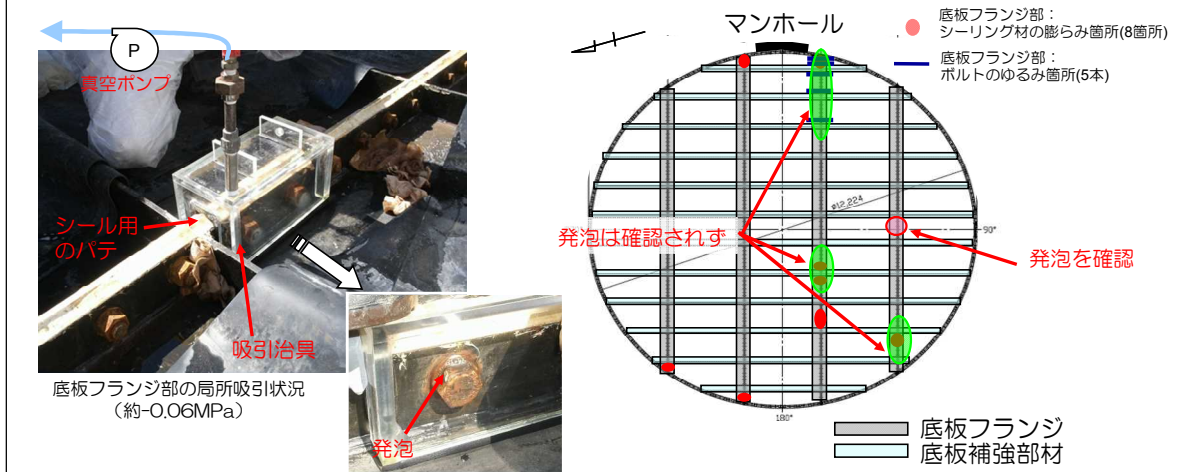


Fig. 4 Investigation Results (3) (localized vacuum test on baseplate)

- A visual check of inside the tank was performed, confirming there were deformations and damage in the sealing material on the flanged section between the sideplate bottom part and baseplate, as well as that on the flanged section of the baseplate (confirmed also at tank No. 10 where there was no leakage).
- The state of fastening was checked through a bolt tapping test, confirming looseness in 5 bolts.
- Rust was confirmed running vertical on one sheet on the inner surface of the sideplate's first layer.

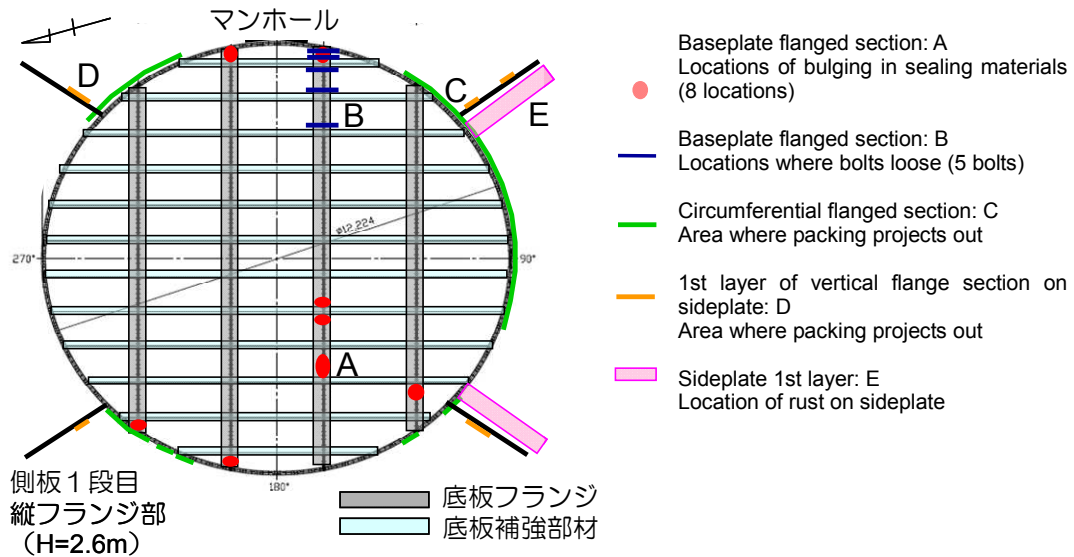


Fig. 5 Investigation Results (4) (results of bolt tapping and visual checks)

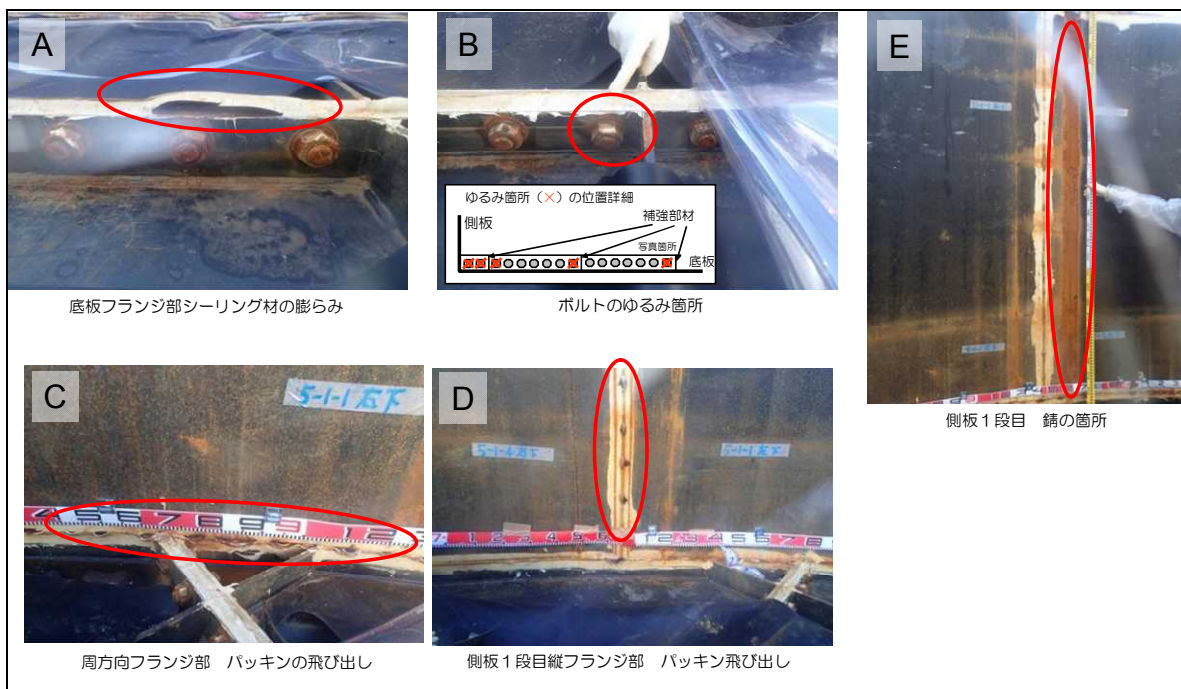


Fig. 6 Investigation Results (4) (photos of tank inner surfaces)

- A discolored section (thought to be a rust outbreak) on the sideplate's inner surface formed of a substance (possibly a blend of the sand components and corrosive products found in the RO concentrated water) that could be easily peeled away had adhered (the aforementioned substance had possibly become charged and adhered preferentially to the corroded section) on top of the coating.
- The coating of the section concerned had been applied several days after the welded sections concerned were inspected, but the section was not checked for cleanliness at the time. For that reason, it is thought that the section concerned had deteriorated relatively more than the surrounding sideplate coating and corrosion thus occurred.
- The coating for the most part remains below the discoloration, with corrosion under the coating only slight. It is not thought to be something that will affect integrity.

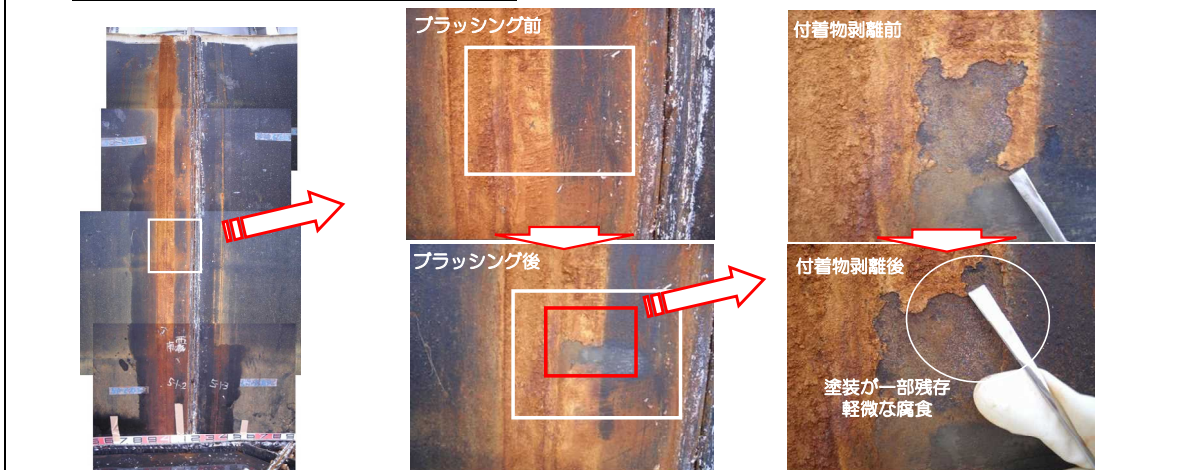


Fig. 7 Investigation Results (4) (rust outbreak confirmed on inside sides)

- The results of the dosage measurements for the flanged sections on the tank's inner surfaces were largely 10 mSv/h or less (beta: 70  $\mu$ m dose equivalent rate) with a maximum of approximately 22 mSv/h (beta: 70  $\mu$ m dose equivalent rate).
- The results of the dosage measurements on the tank's outer surfaces (sideplate 1st layer and baseplate periphery) were 10 mSv/h or below for the most part, but one location (rusted section) with relatively high radioactivity (approx. 40 mSv/h) was confirmed near the welded section connecting the sideplate and the sideplate flange.

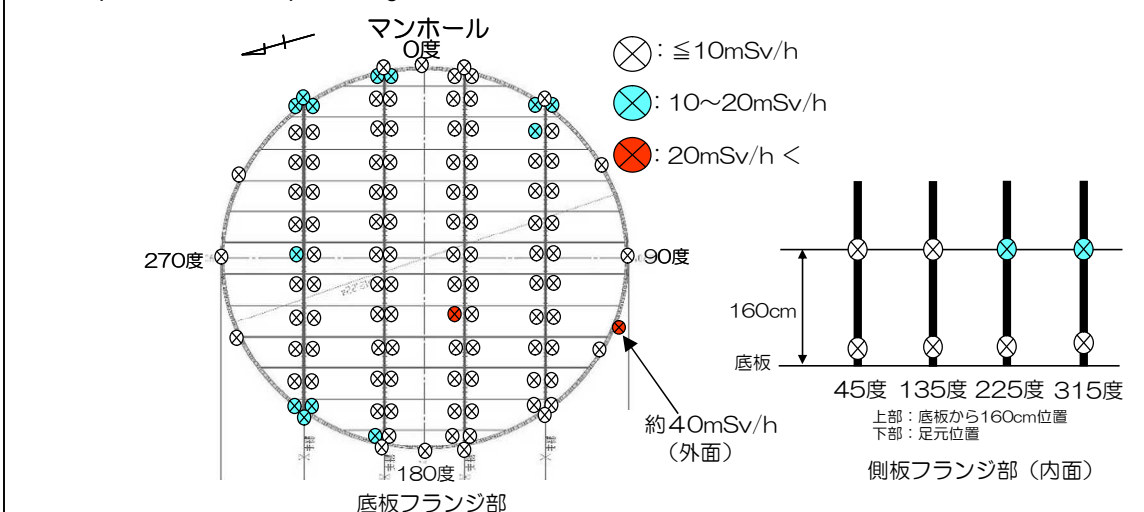


Fig. 8 Investigation Results (5) (radiation dosage measurements)

- Localized suction (-0.06 MPa) was applied (9/19) to the location (rusted section) where relatively high radioactivity was detected near the welded section connecting the sideplate and sideplate flange.
- The bubbling agent applied to the section in question did not produce continuous foaming. Foam coated on the inside of the tank likewise was not suctioned in.

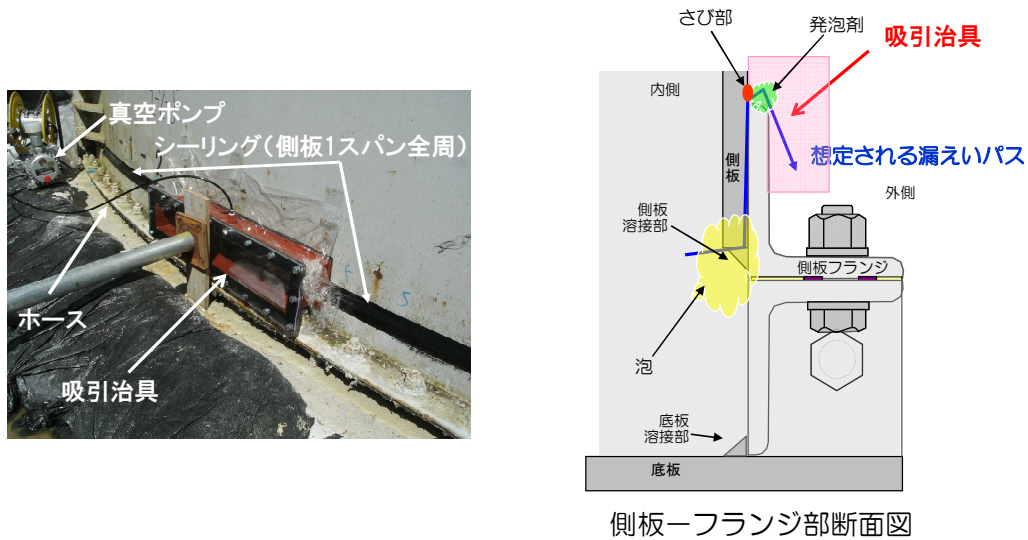


Fig. 9 Investigation Results (6) (vacuum test on sideplate)



Summary of Investigations into Locations of Tank Leaks (during and after dismantling)

Event	Results of pre-dismantling investigations*1	Mid-dismantling investigations*2		Post-dismantling investigation		Leakage path present?+3	Remarks	
		Investigation details	Investigation results	Investigation details	Investigation			
Leakage from sideplate	Leakage from base material (welded)	△	Vacuum test rerun excluding sealing on inner surface at those locations (section with rust outbreak) where relatively high radioactivity was confirmed	No leakage path	—	—	X	
	Leakage from flanged section	△	Liquid PT applied to inner surface to check for seepage to outside Bolt torque measurements	No leakage path Reduction in torque	*Liquid PT applied to check flange surfaces after dismantling *Visual check of external appearance and dosage measurement of flange	No leakage path	X	Refer to investigation results (1), (2)
Leakage from baseplate	Leakage from flanged section	○	Measure separation and level differences among flanges	Differences in levels confirmed	*Visual check of external appearance (for rust outbreaks, conditions of packing, traces of leakage paths [using PT]) and dosage measurements of flange surfaces and bottoms *Check for corrosion and deformation of bolts *Visual check of packing at flange joint areas	Liquid PT remains at leakage path sites	○ 2 bolts where suctioning in of foam confirmed	Refer to investigation results (3) to (9)
			Baseplate vacuum test performed to check for changes in separation and level differences between flanges and, after removal of sealing, for leakage paths on flange surfaces	No leakage path on flange surfaces				
			Bolt torques measured	Reduction in torque confirmed				
			Vacuum test repeated with 2 bolts that are sites of possible leakage paths removed, confirming leakage path inside bolt holes	Leakage path present				
			Liquid PT applied after sealing and other material removed (check flange surfaces after dismantling)	Only leakage paths already confirmed				

\*1: ○ - Confirmed possible leakage path, △ - Possibility of leakage path cannot be denied

\*2: Conditions after sealing materials removed \*3: ○ - Leakage path present, X = No leakage path present Liquid PT: Liquid penetrant

Fig. 1 Summary of Investigations into Locations of Tank Leaks (during and after dismantling)



Fig. 2 Investigation Results (1) (results of visual check of sideplate flange surfaces)

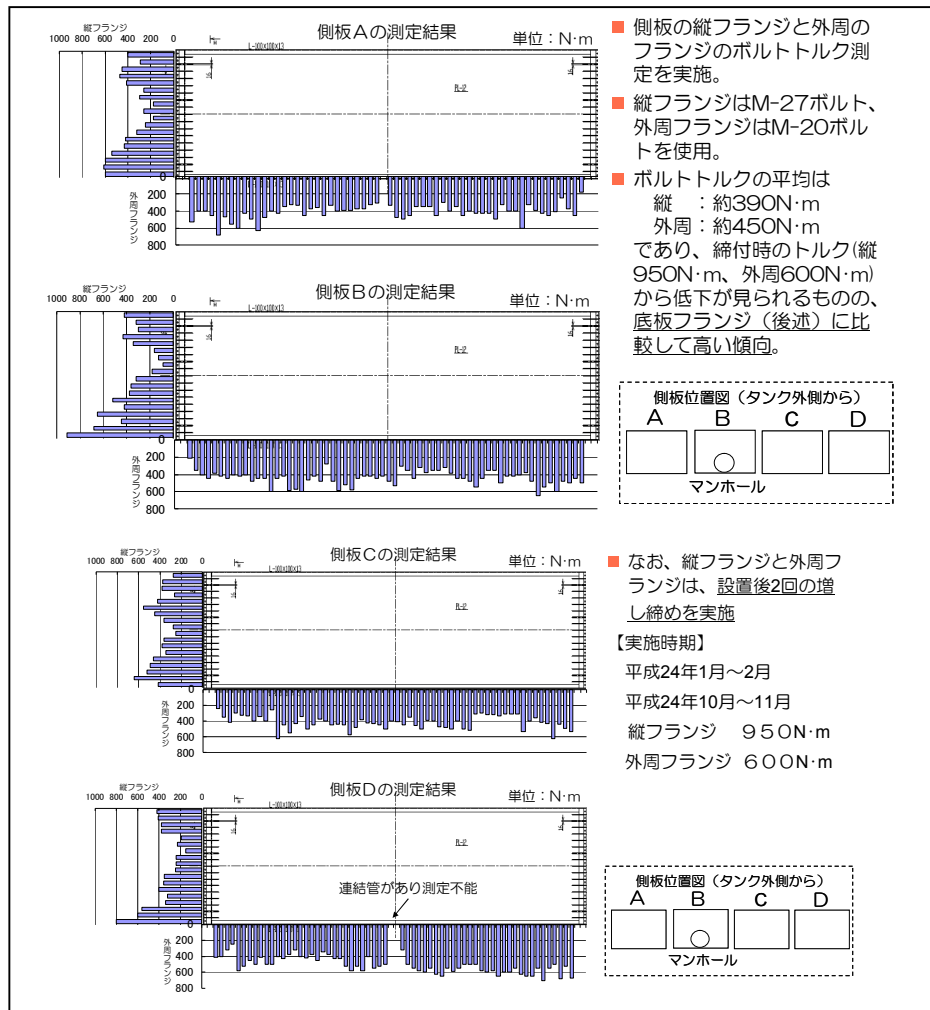


Fig. 3 Investigation Results (2) (bolt torque measurements for sideplate 1st layer)

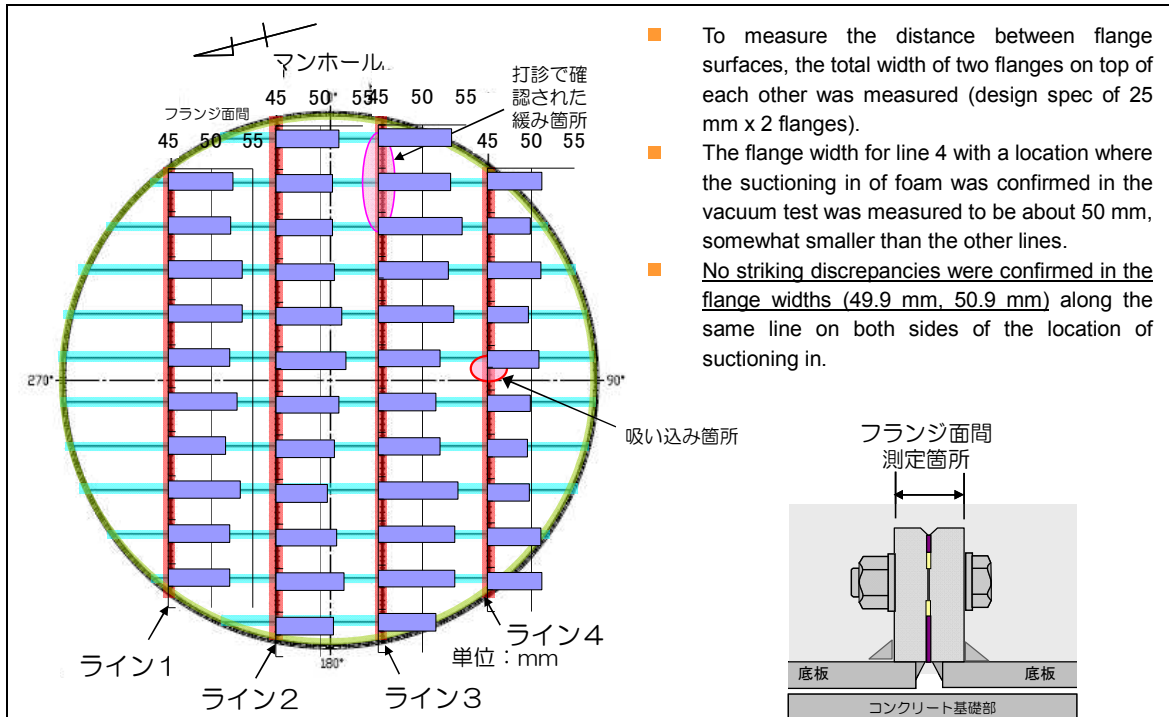


Fig. 4 Investigation Results (3) (measurements of separations between baseplate flanges)

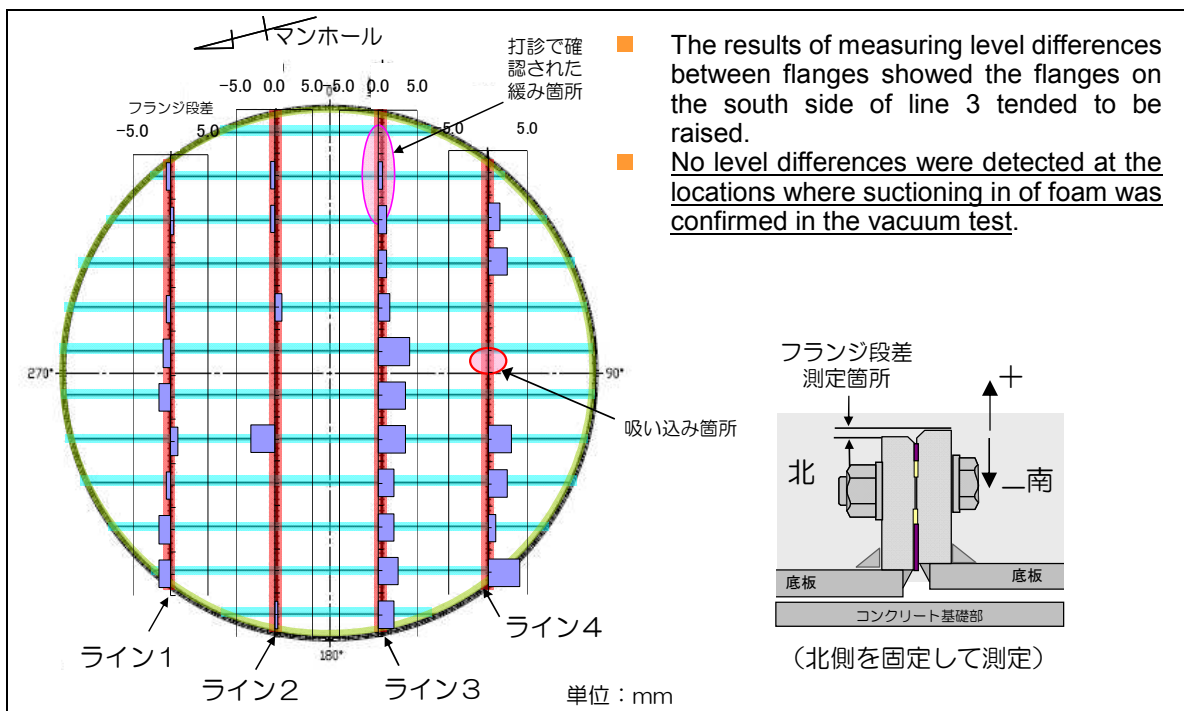


Fig. 5 Investigation Results (4) (measurement of level differences between baseplate flanges)

- For those bolts where possible leakage paths were detected in the baseplate vacuum test, the gaps at sites of leakage paths (those between flanges and washers, and washers and bolts) were measured using a feeler gauge confirming the maximum gap to be approx. 0.23 mm.

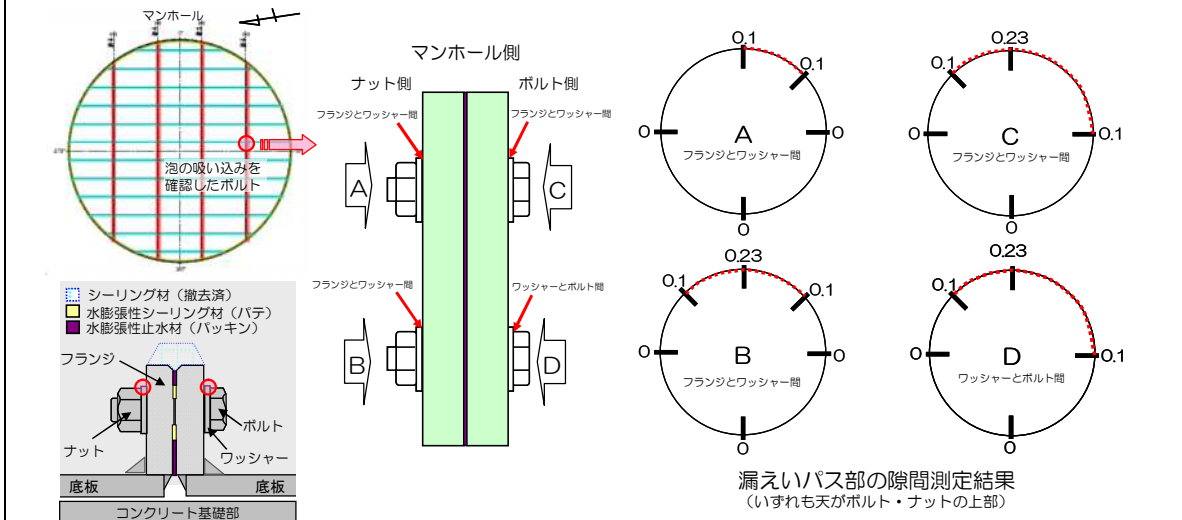


Fig. 6 Investigation Results (5) (measurements of gaps at bolts)

- The 2 baseplate bolts confirmed to be leakage paths were removed and both a visual check of external appearance and baseplate vacuum test were performed.
- The external appearance visual check confirmed that in the lower part of the gap between flanges at the bolt holes had opening that were approx. 3 mm wide and 22 mm long at the bolt to the east side and approx. 2 mm wide and 11 mm long at the bolt to the west.
- The baseplate vacuum test confirmed that foam was suctioning in from the confirmed opening.

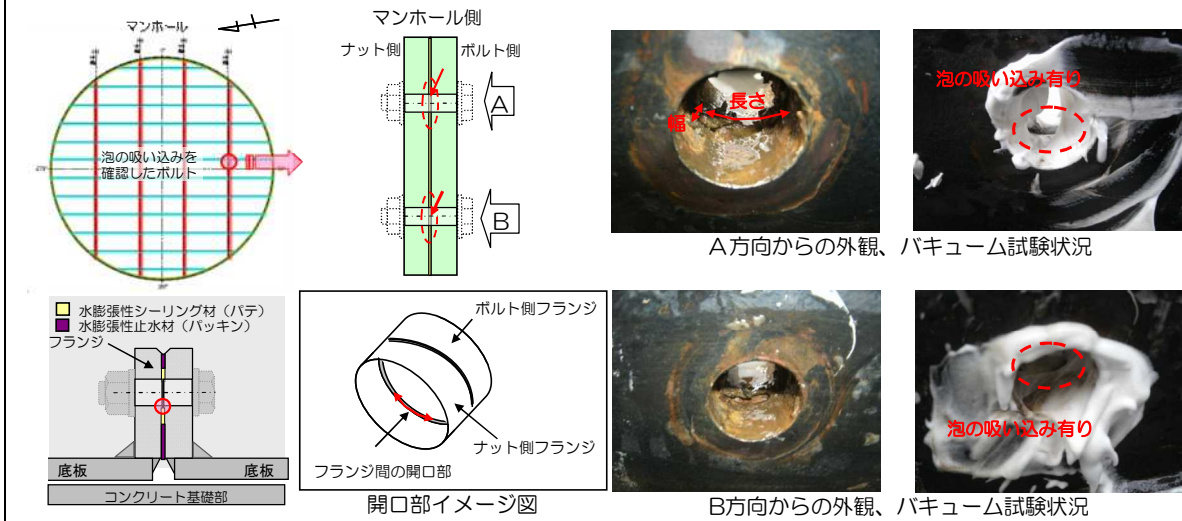


Fig. 7 Investigation Results (6) (check of baseplate flange bolt holes)

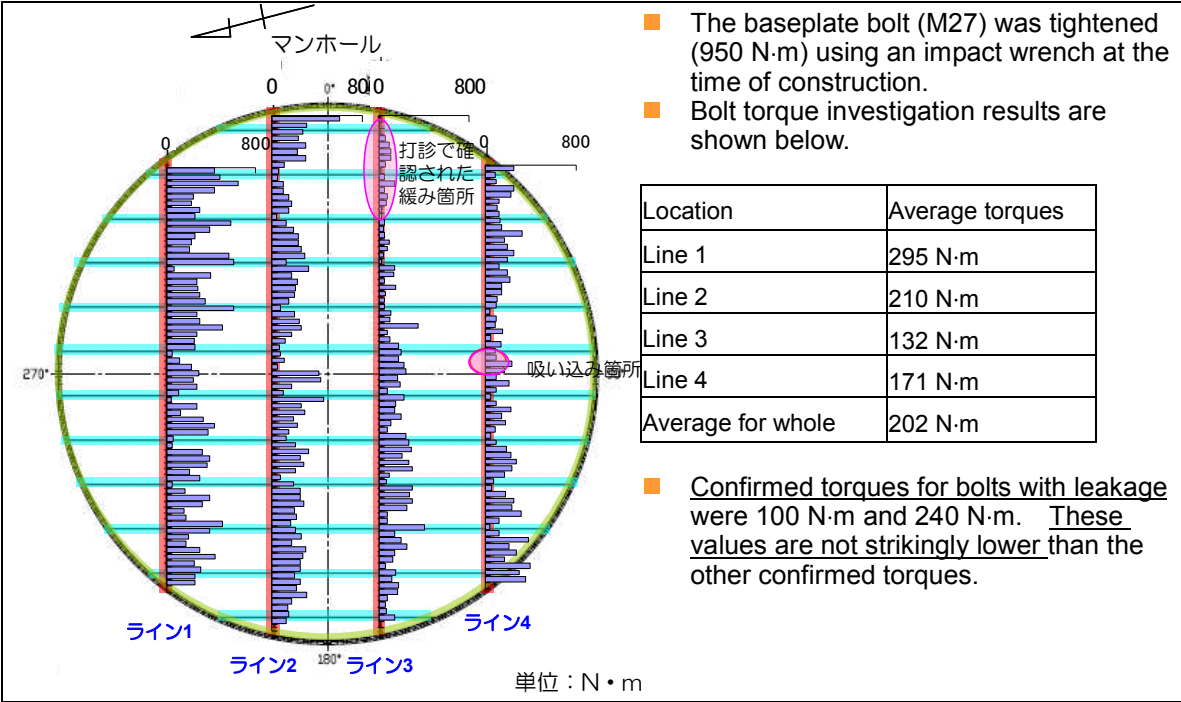


Fig. 8 Investigation Results (7) (baseplate flange bolt torque measurements)

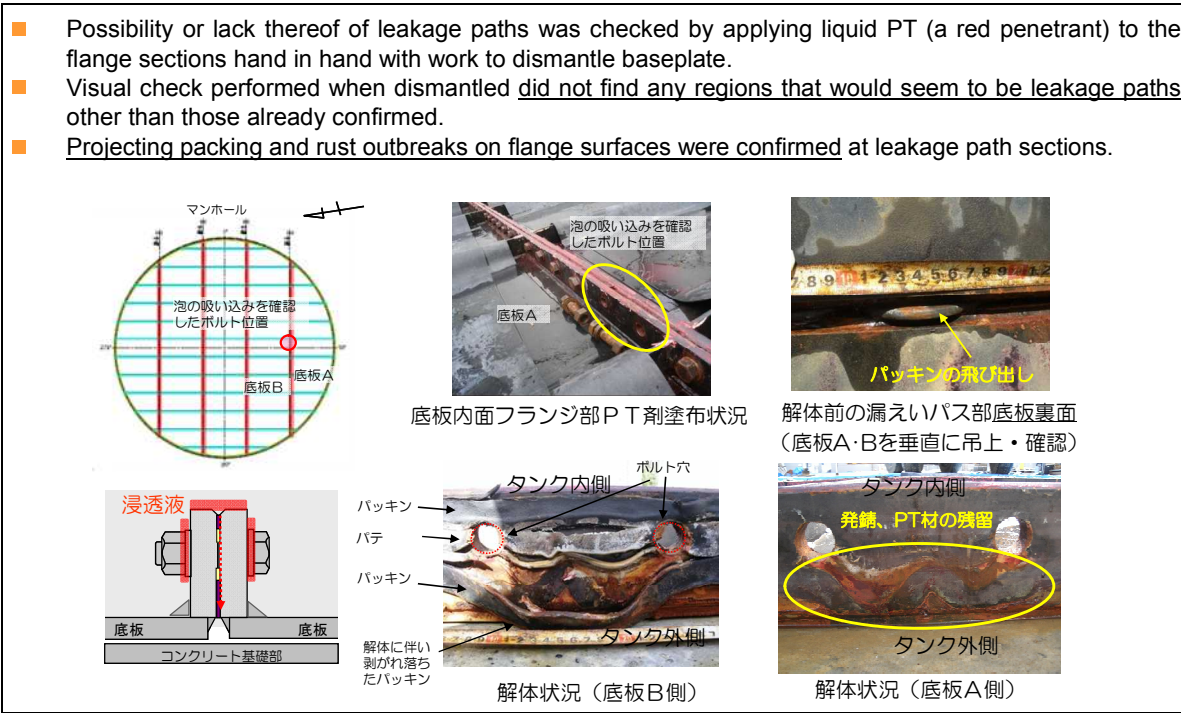


Fig. 9 Investigation Results (8) (visual checks of baseplate flange surfaces)

- A check of the flange surfaces found that the surfaces at the point of contact with packing at leakage path locations were considerably askew, and that the upper edge of packing traces was penetrating through the lower edge of the flange surface.
- Rust outbreaks were discovered between the putty and upper edge of the packing traces on the flange surface, as well as on the outer surface of the tank baseplate.
- The rust outbreaks on the flange surface and outer surface of the baseplate are thought to be corrosion produced by water that got into the gap that emerged between the putty and upper edge of the packing and went through to the bottom.

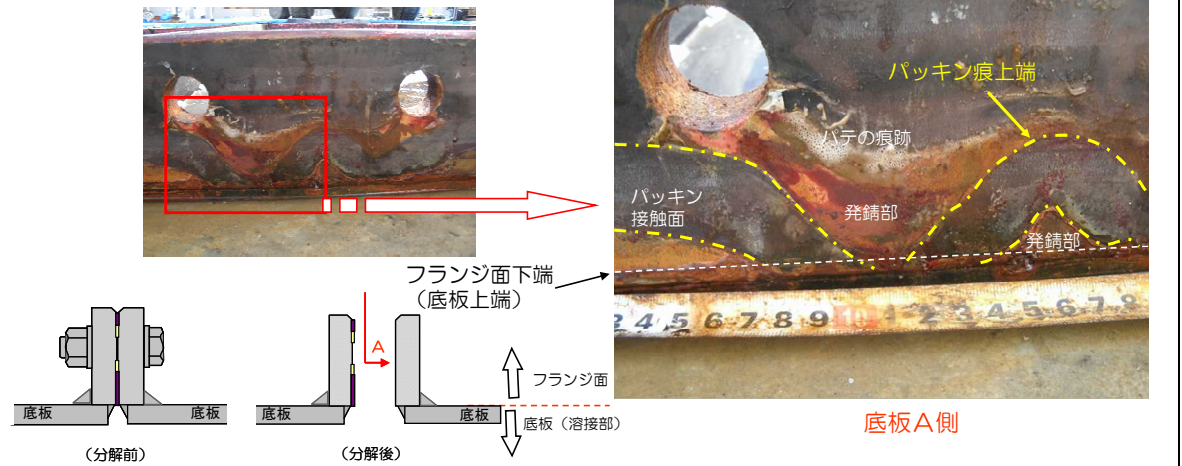


Fig. 10 Investigation Results (8) (leakage path inspections)

- The openings at flanges (the opening of the lower edge with respect to the upper edge) were measured for those flanges that had leakage locations.
- Openings on the bottom sides of the flanges were confirmed at those locations with suctioning and on line 4, but they were slight (on the order of 1 to 2 mm) compared to the separation between the upper and lower edges (approx. 116 mm).

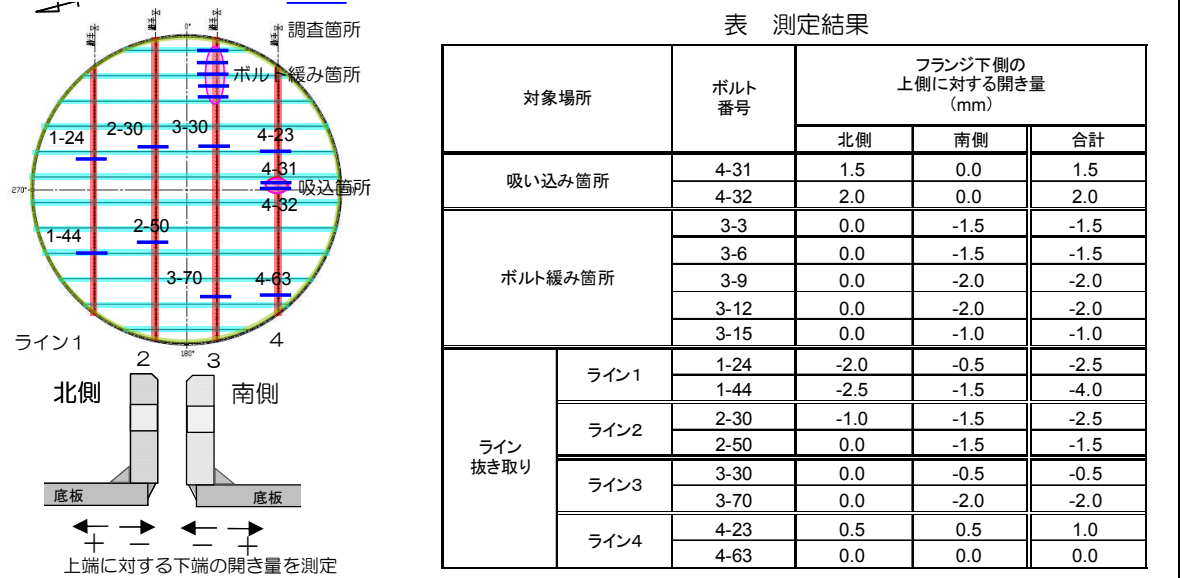


Fig. 11 Investigation Results (9) (measurements of openings at baseplate flanges)

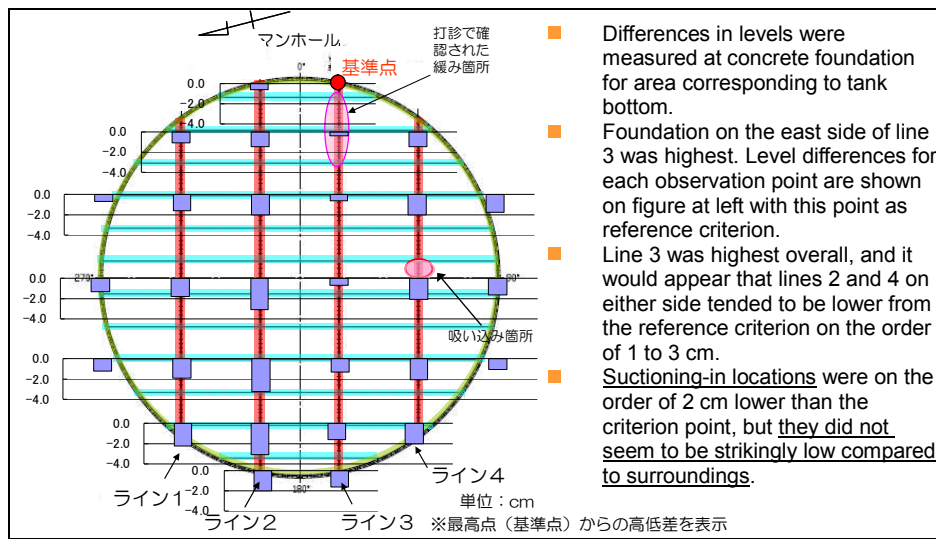


Fig. 12 Investigation Results (10) (measurements of level differences for concrete foundation)

Job item	Item confirmed	Timing	Criterion	Pass or fail (O or X)	Remarks	
Water tank water spreading test	Levels at 4 points outside water tank	After water spreading test completed	No subsidence in water tank Level measured Amount of subsidence within 45 mm +/-	Measured values		
		24 h after water spreading test completed		Crit	24 h	
	Water levels measured inside tank	After water spreading test completed	No changes to water levels inside tank Measured to scale, 0 mm +/-	Measured values		Measure at 2 places in event that water tank tilted
		24 h after water spreading test completed		Crit	24 h	
	Visual check of outside of water tank (no seepage of water)	During spreading test	No seepage of water outside water tank	Pass Fail		
		After water spreading test completed				
		24 h after water spreading test completed				
	Visual check of outside of water tank (no seepage of water)	During spreading test	No seepage of water outside water tank	Pass Fail		
		After water spreading test completed				
		24 h after water spreading test completed				

Fig. 13 Investigation Results (11) (water tank water spreading test results, area H4 north cluster I tank No. 5 only, performed October 7, 2011)

## Considerations regarding Results of Root Causes Investigation of Tank Leakage

**Table 1: Classification of Probable Causes**

Factors in Occurrence (hypothesized)		Confirmation method	Result of checks	Assessment
Defective quality of materials	Error in selection of components of steel plates, bolts, etc.	Records of materials (mill sheets)	SS used for steel plates, SCM used for bolts; confirm that materials selected mindful of characteristics, etc., of inner fluids	x
	Mistakes with components for steel plates, bolts, etc.	Records of materials (mill sheets)	Confirm there were no mistakes re components in records of materials at builders when components were delivered	x
	Poor welds by factory welding department	Interviews Results of water spreading trial (Attachment-21, Figure 13)	Manufacture confirm at factory that there are no poor welds when checking after welding	x
	Bends in flanges	Measurement of flange opening (Attachment-21, Figure 11)	Openings toward bottom ends of flanges were checked at locations of leakages, but founds to be insignificant	Δ
Poor workmanship	Poor workmanship with sealing materials and waterproofing materials between flanges	Interviews Results of water spreading trial (Attachment-21, Figure 13)	* External appearance check by builders after construction that there was no poor workmanship * Check by builders and TEPCO that water spreading test shows no anomalies	x
		Visual observation of flange joint surfaces (Attachment-21, Figures 9 and 10)	Possibility based on putty condition that slight swelling occurred in the packing (bottom side) when bolts were fastened, but hypothesis is that packing was flat for the most part	Δ
	Insufficient torque in fastening bolt	Interviews Results of water spreading trial (Attachment-21, Figure 13)	* Check by builders that bolts are fastened at established torque values * Check by builders and TEPCO that water spreading test shows no anomalies	x
	Element deformations in steel plates, etc., in keeping with ground subsidence	Interviews Results of water spreading trial (Attachment-21, Figure 13)	* Tank concerned dismantled after ground subsidence occurred to confirm through visual check of external appearance of components by builders that there were no anomalies * Checks by both builders and TEPCO when reassembling to confirm at installation and with water spreading test that there were no anomalies	x
	Impact of level differences in concrete foundation	Measurements of concrete foundation (Attachment-21, Figure 12)	While level differences on order of 1 to 3 cm exist, confirmed that situation not such that the levels are strikingly different between the locations of leaks and surrounding areas	x
	Poor linkages in baseplate flanges	Measurement results (Attachment-21, Figures 4 and 5)	Confirmed that there were no striking discrepancies with other areas when it came to the spaces between baseplate flanges in vicinity of leaks, and that there were no level differences in the flange baseplates at the leak sites.	x
Deterioration of materials during operation	Corrosion of components such as steel plates and bolts	Visual check of external appearance (Attachment-20, Figure 7)	Confirmed that progress of rust did not seem to be striking and did not seem be anomalies such as deformation	x
	Damage and deterioration in sealing materials and in waterproofing materials between flanges	Visual observation of flange joint surfaces (Attachment-21, Figure 10)	Checked to see if packing had come off from flange bottoms, based on packing traces at flange joint areas and rust outbreak situation	O
	Drop in torque of fastening bolts	Check bolt torques (Attachment-21, Figures 3 and 8)	Torque has dropped on the whole, but situation not such that bolt torque alone at spots with leaks has dropped to striking degree.	Δ

O: Conceivably a direct cause; Δ: Conceivably an indirect cause; X: Not a cause



- 漏えい部のフランジ接合面におけるパテの残存状況から、ボルト締め付け時にパッキン（底板側）に若干うねりが生じた可能性はあるが、概ね水平に設置されていたと推定。
- なお、タンク設置時の水張試験において、水位に変化がないこと（漏えいがないこと）を確認。
- 最終的なパッキン（底板側）上端の痕から、ボルト締め付け時以降、気温変化等によるフランジの熱膨張、収縮とタンク水圧等により徐々に落下し、最終的に底部に抜けて開口に至ったものと推定。

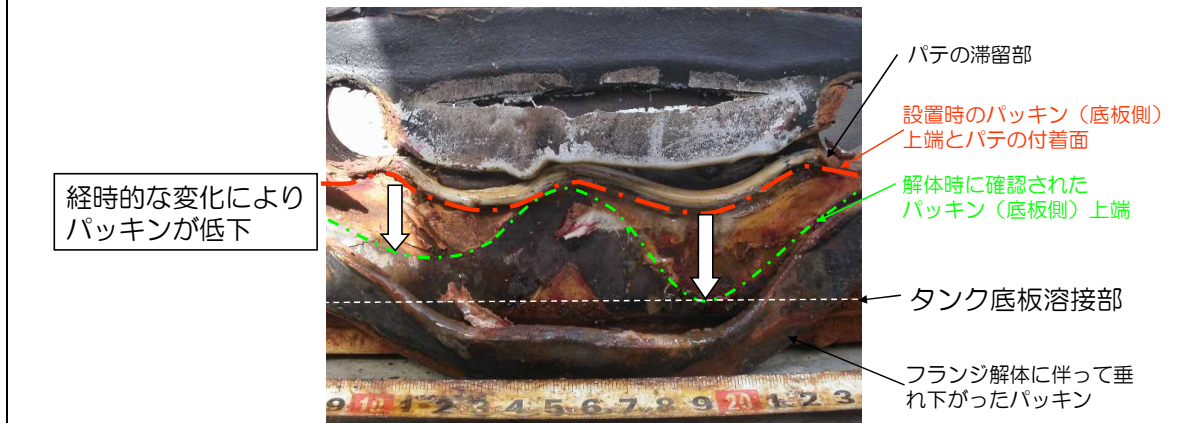
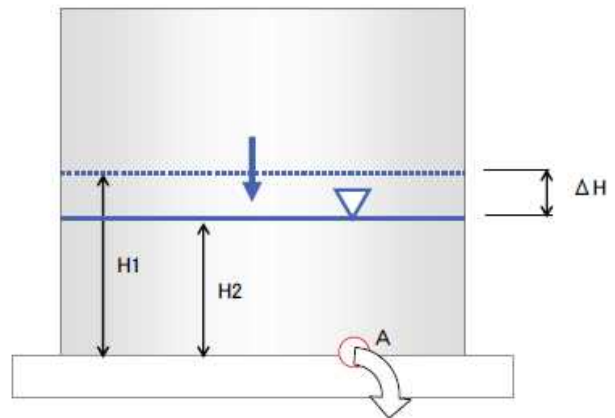


Fig. 1 Surmises regarding the process by which leakage paths formed

## Estimated Area of Leakage Based on Leak Rate

### ■ 計算条件

タンク半径R：6m  
 水位（初期）H1：6m  
 水位（6時間後）H2：5.95m  
 水位低下量 $\Delta H$ ：0.05m  
 漏えい時間T：6時間



### ■ 漏えい面積Aの算出

漏えい量 $Q = At \times \Delta H$   
 タンク底面積 $At = \pi R^2$   
 流速 $V = Q / AT = \sqrt{2gH1}$   
 漏えい面積 $A = Q / T \sqrt{2gH1}$

≒長さ25mm程度・開口（隙間）1mm程度と仮定

### Computation of opening area based on gap measurements

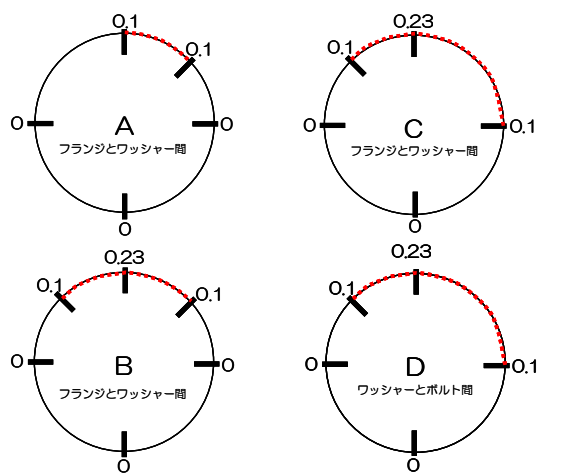
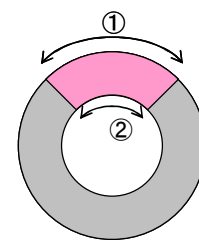


図1 漏えいパス部の隙間測定結果  
 (いずれも天がボルト・ナットの上部) 単位:mm



① 開口範囲  
 ② ワッシャが密着している範囲

①: 目視で確認した開口部長さ  
 → 外径で計算  
 ②: リーク量に寄与するリークパス長さ  
 → 内径で計算

図2 リークパス範囲の想定

### ■ Calculation Method

Assuming conditions as shown in Figure 2, area of opening calculated from inner sides of washer (bore diameter 28 mm)

Area of opening = Length along circumference of site of leakage path x gap between ends + Length along circumference of site of leakage path x 1/2 x (maximum gap - gap between ends)

### ■ Calculation results (area of opening)

A area (1.1) + B area (3.6) + C area (5.4) + D area (5.4) = approx. 16 mm<sup>2</sup>

### Results of Checks for External Radiation Exposure due to Beta Radiation for Workers around Area H4 North

While no changes in exposure while on tank patrol were apparent, external radiation exposure while working at the radio relay station due to previously undetected beta radiation was confirmed in July.

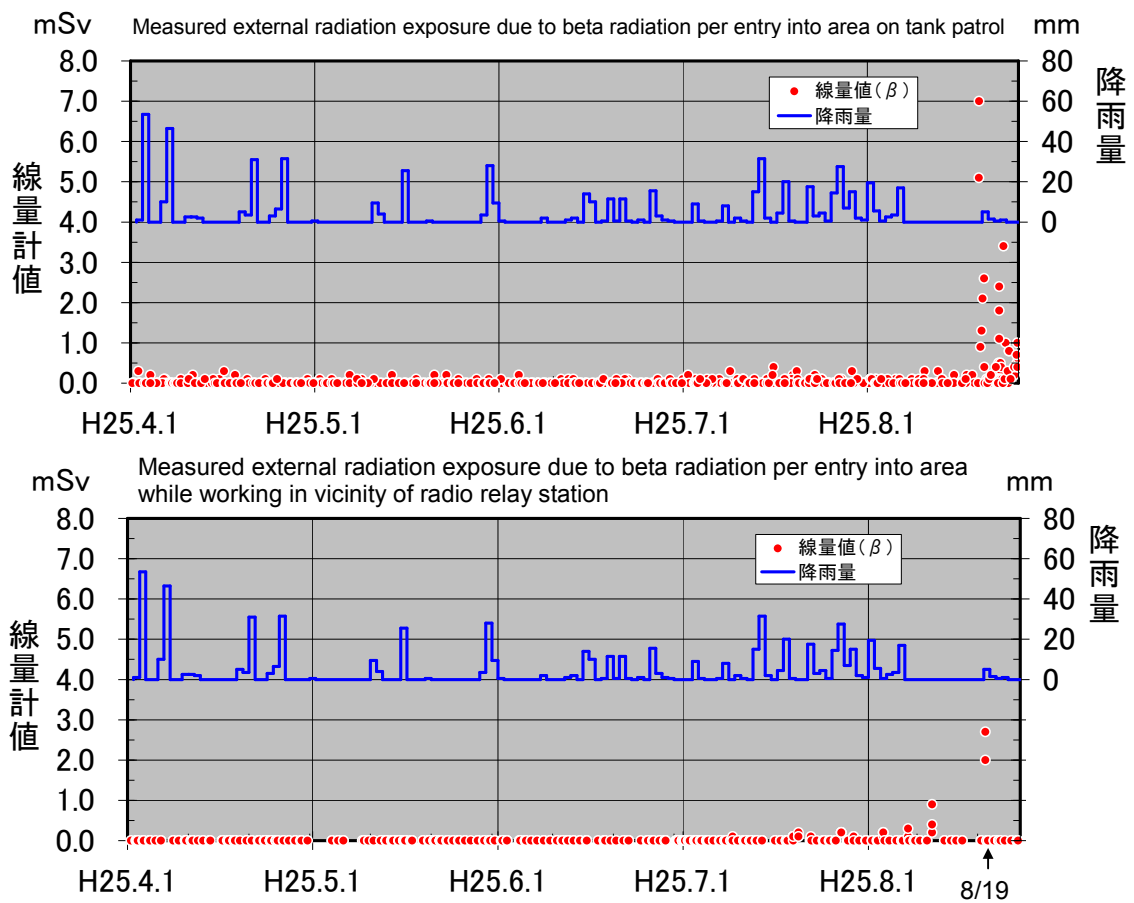


Fig. 1 Amount of external radiation exposure due to beta radiation for workers around area H4 north and amounts of rainfall (As measured by alarmed portable dosimeters)

## Results of Concrete Foundations Investigation

- タンク底部解体後に若干の残水（水深数mm）がある状況の中、コンクリート基礎の調査を実施した結果、非常に微細で、かつ密着したクラック（幅0.03mm以下、長さ約80cm）を1箇所確認
- なお、当該タンク付近の溜まった雨水の水位が低下する傾向はみられていない

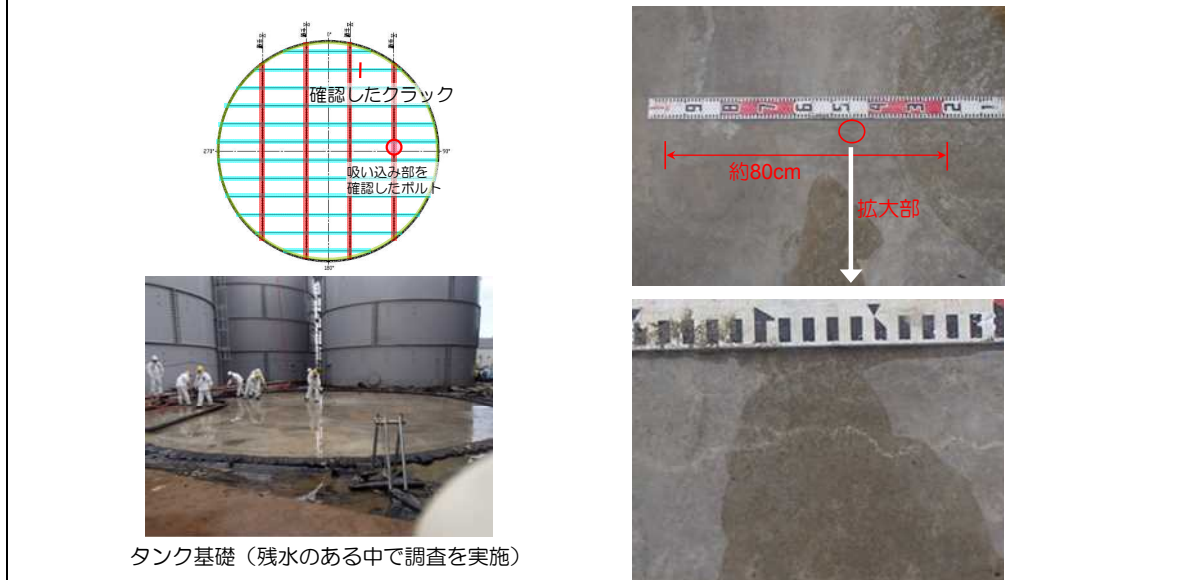


Fig. 1 Visual check of concrete foundation

### Countermeasures

■ Countermeasures related to tank leakage

○ Provisional countermeasures taken until tanks have been replaced with welded models

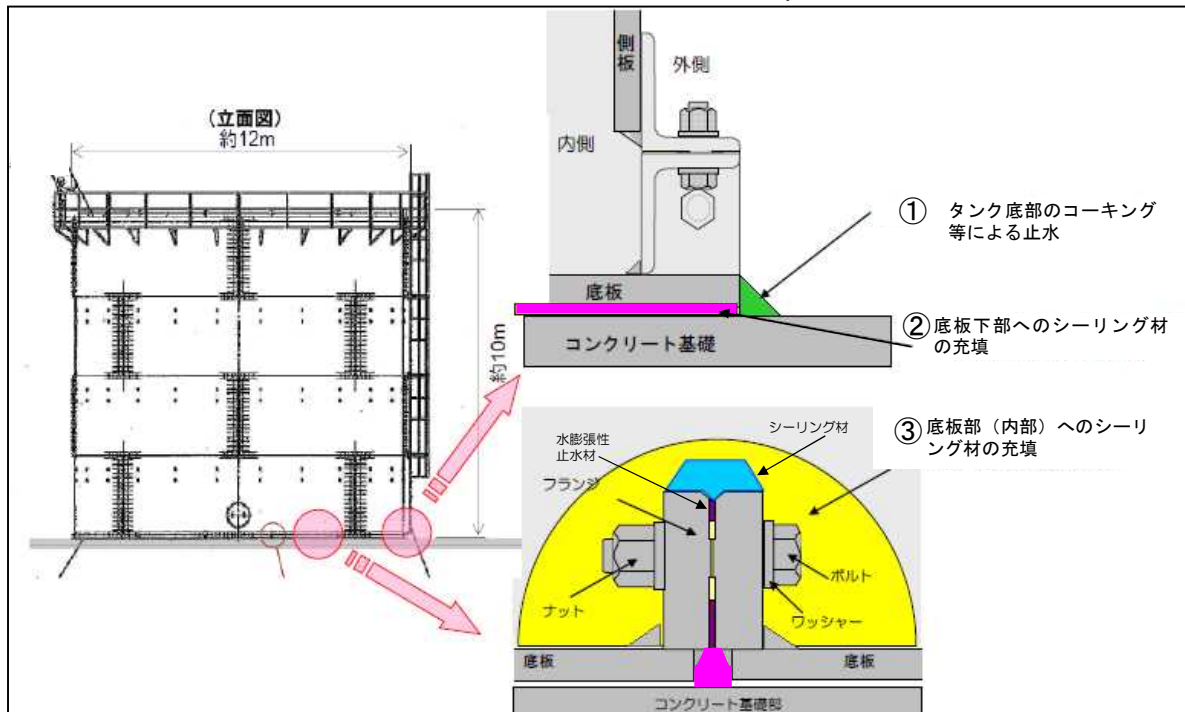


Fig. 1 Illustration showing provisional countermeasure in place until welded replacement tanks installed

(1) Waterproofing by caulking tank bottoms (countermeasure that can be quickly implemented)  
- Apply concrete to inside of tank area dikes and implement caulking with same material around the tank bottoms

(2) Pack sealing materials into bottom part of baseplate (further improve reliability)

■ Build section mock-ups

- Build section mock-ups using test bodies modeled on tank baseplates. After building, confirm waterproofing of holes with respect to simulated tank hydraulic pressure

■ Build mock-up of actual equipment

- Build a mock-up of actual equipment to confirm whether it will be possible to carry out project on bottom of baseplate flanges. Project begun in January 2014 with verification effort focused on establishing method for carrying it out.

Illustration showing project being carried out

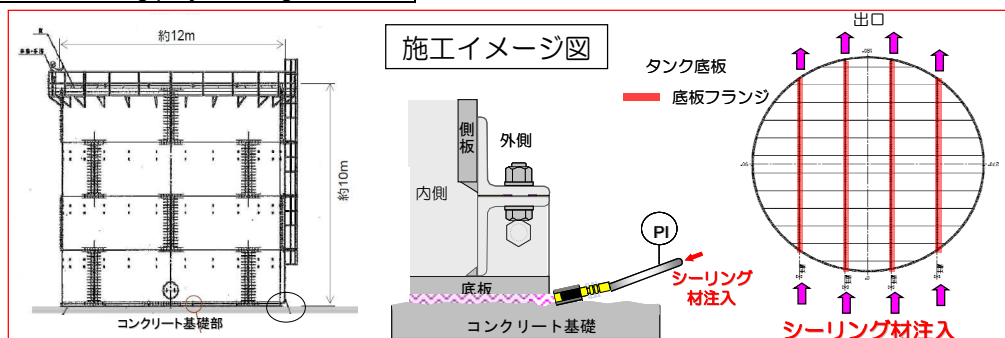


Fig. 2 Illustration showing project being carried out

(3) Pack sealing materials into (inside) baseplate (further improve reliability)

■ Studies related to resins to be applied

- Decide whether possible to apply to flanged tanks based resin coating techniques proven elsewhere in Japan or the world

■ Carry out section mock-up tests

- Confirm the possibility of installing on flange sections as well as its adhesiveness when it comes to coated tank surfaces

■ Studies aimed at putting actual equipment to use

- Continue to do studies and verifications to confirm workability, overall equipment design and manufacture, and operability.

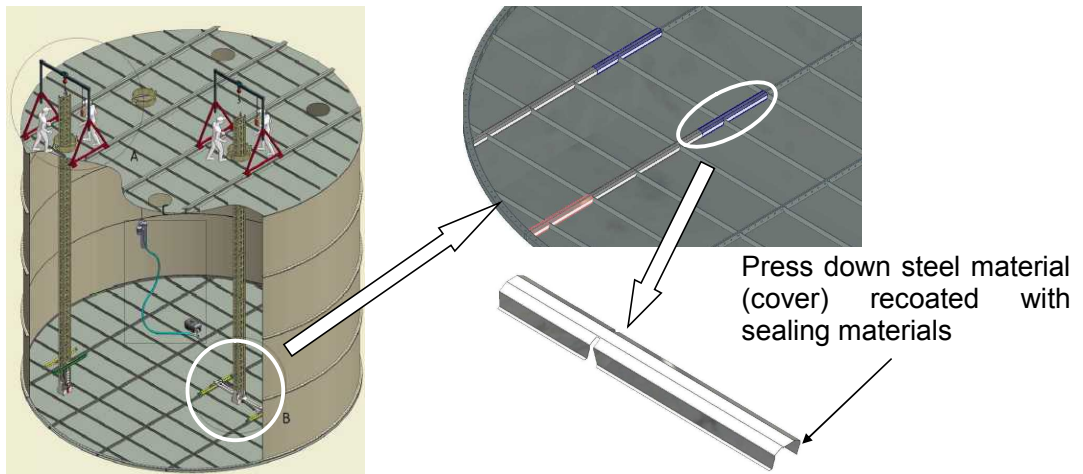


Fig. 3 Illustration showing project being carried out

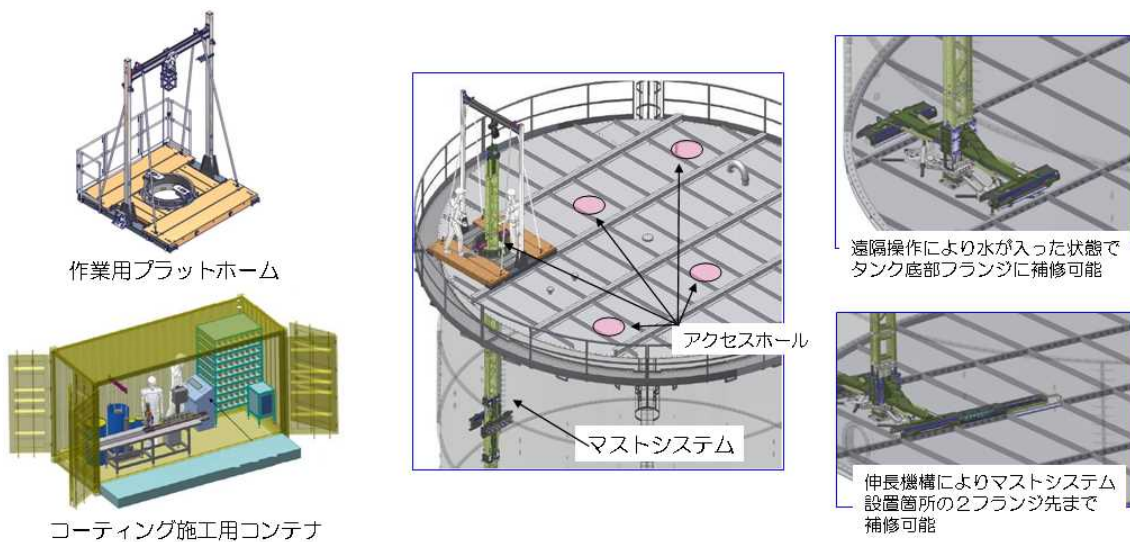


Fig. 4 Illustration showing project being carried out

oProvisional countermeasures taken until tanks have been replaced with welded models  
Investigations at other flange-style tanks (types 2 through 5)

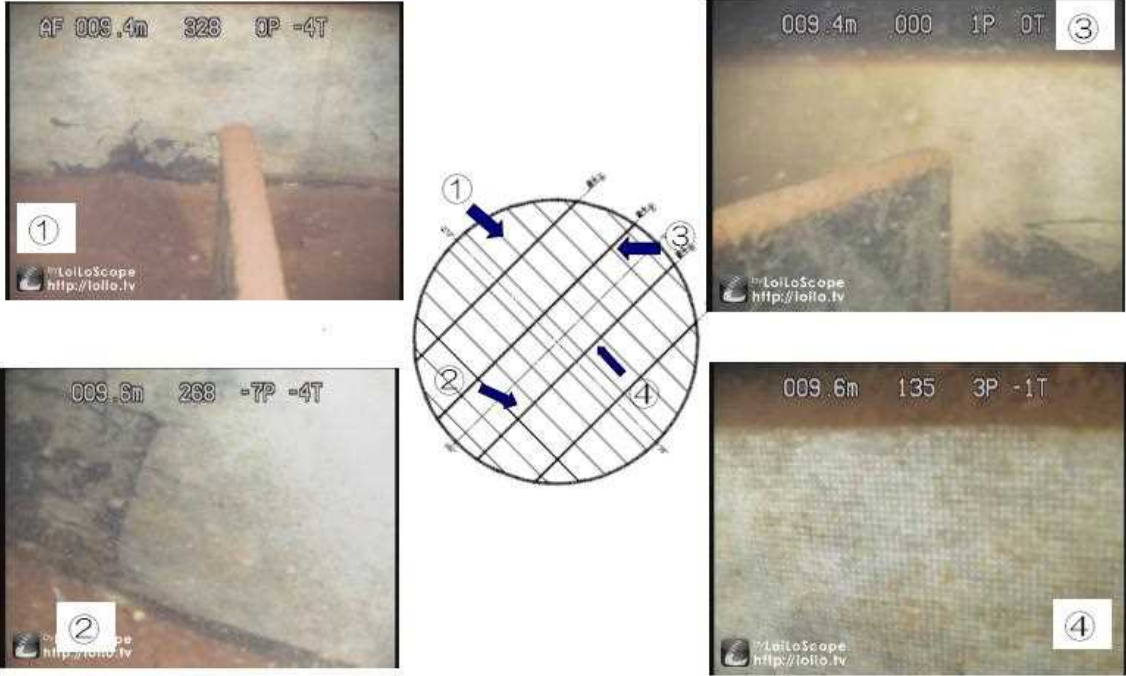


Photo 1 Example of Type 3 tank, showing coupler at bottom of area E tank

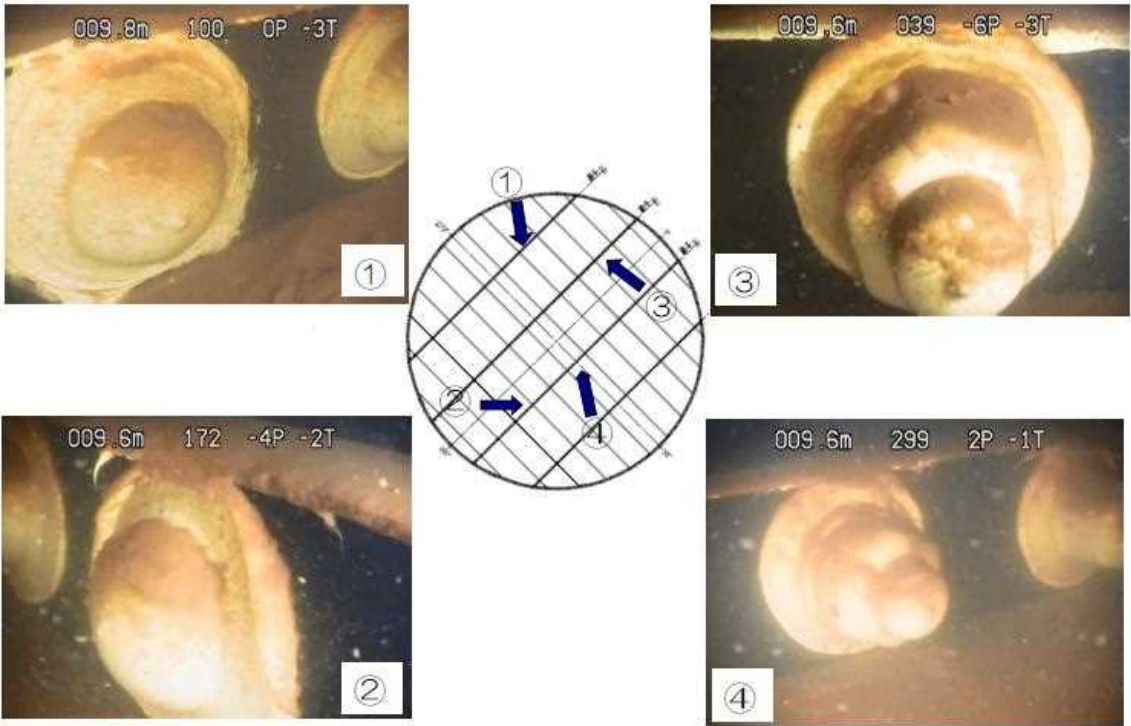


Photo 2 Example of Type 5 tank, showing coupler at bottom of area H2 tank

- Measures to prevent leaks from expanding
- Increasing the height of the tank dike

■ **Build floodgate embankments using steel plates (stopgap floodgate)**

- Embankments have been built in area H4 north, where contamination levels are highest; area B, where foundations are tilted; and at those locations in H1 east where crowns on floodgates are low
- Already carried out at all other areas (embankments raised approx. 30 cm)

■ **Further embankments on floodgates using concrete and similar materials (improve reliability)**



Photo 3 Status of building floodgate embankments using steel plates (area H4 north)

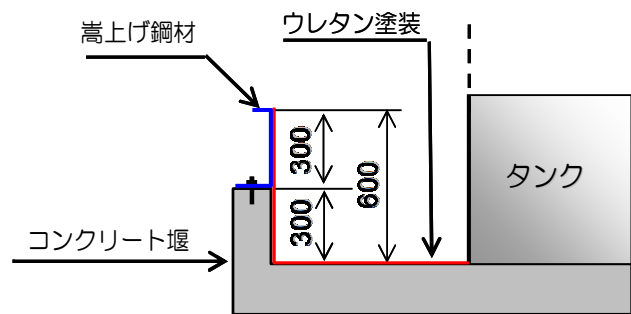


Fig. 5 Status of embankments using steel plates

- Double layering of dikes and preventing seepage into the earth on the surface of the ground between inner and outer dikes

■ **Cover concrete surfaces inside dikes, prevent seepage through surface of grounds within outer dikes**

- Cover concrete surfaces inside the floodgates and improve waterproofing
- Lay concrete for preventing seepage so as to keep rainwater from soaking into the ground between the outer and concrete dikes



Photo 4 Status of covering surfaces

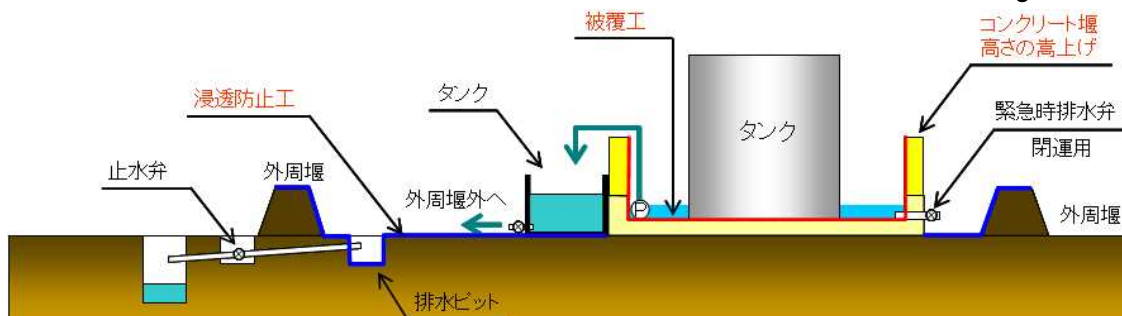


Fig. 6 Sectional view of tank yard





H1東エリア



H2エリア



H8エリア



H9エリア



H2エリア



Eエリア



H4エリア



J1(中)エリア

Photo 5 Photo showing current conditions

○Prevent influx into drainage ditches

■ Covering of drainage ditches B and C



①ダブルプレスト管施工完了（撮影日H26.1.15）



③FRP管施工完了（撮影日H26.2.7）



②コンクリート蓋施工完了（撮影日H26.1.22）



④止水ゲート施工状況（撮影日H26.2.12）

Photo 6 Photo showing current conditions

■Countermeasures for early detection purposes

○Control rainwater influx



Photo 7 Installation of rain gutters to tank top plate

○Install water gauges at each individual tank



Photo 8 Water gauge installation



Photo 9 Radar-type water gauge

○Side ditch radiation monitors

【漏えい早期検知】

- ① タンクパトロール（溶接タンク：2回/日、フランジタンク4回/日、3人/班×10班）
- ② タンク水位計による監視（常時）

【漏えい範囲拡大防止】

- ③ 堰のかさ上げ（タンク1基分/20基毎）
- ④ 外周堰の設置（排水弁は電動弁化）
- ⑤ 外周堰内の浸透防止（フェーシング）

【海洋への流出抑制】

- ⑥ 排水路の暗渠化
- ⑦ 側溝放射線モニタの設置
- ⑧ 排水路の排水先を港湾へ
- ⑨ 排水路にゲート設置

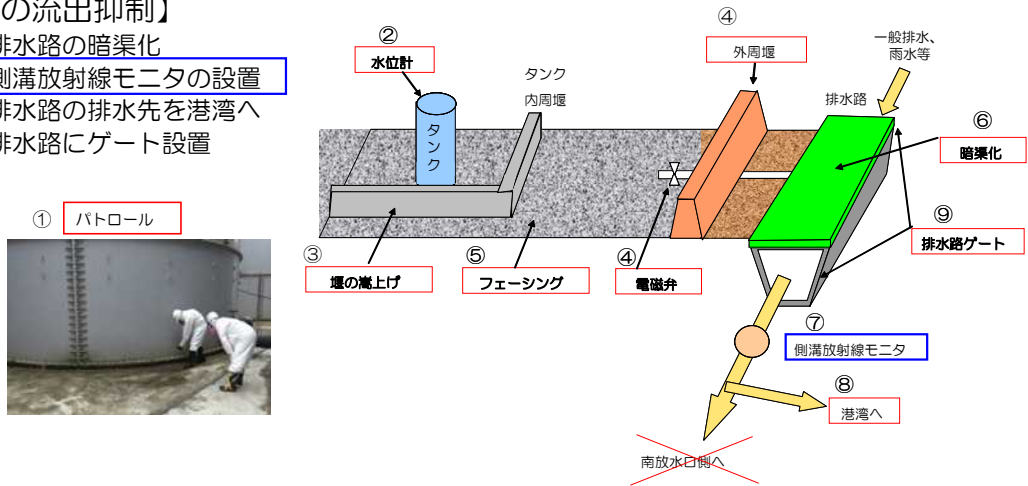


Fig. 7 Positioning of side ditch radiation monitors



Fig. 8 Diagram showing positions where side ditch radiation monitors installed

○Create route for water from drainage ditch network C to drain to harbor

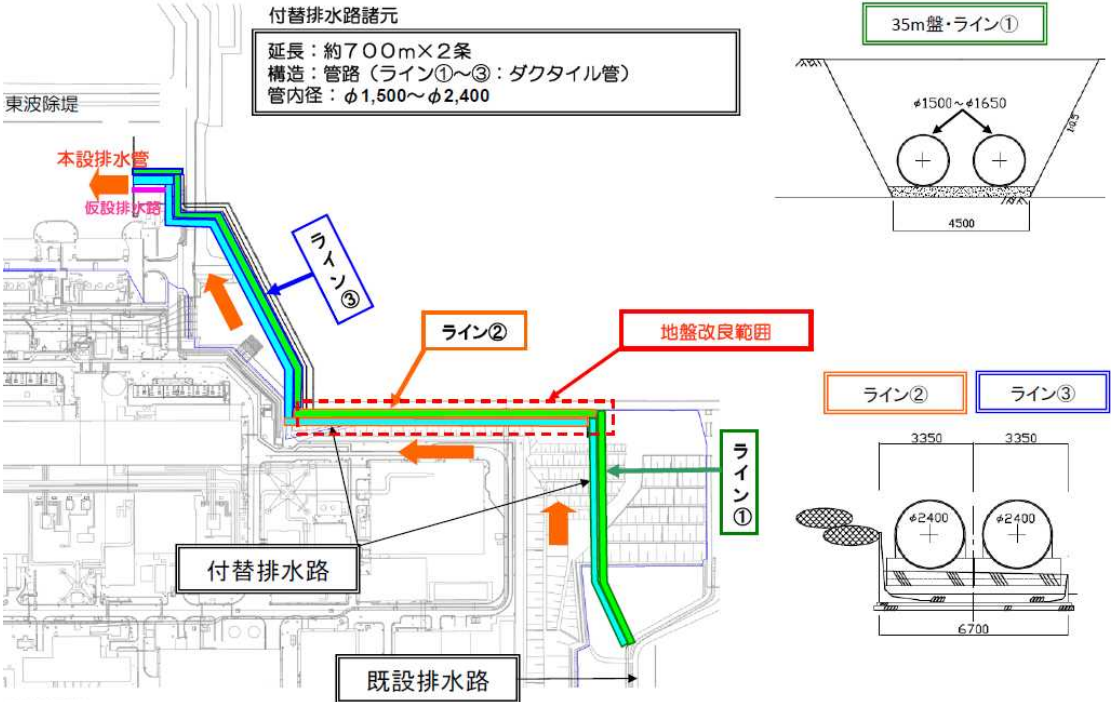


Fig. 9 Plan for drainage ditch network C replacement pipes

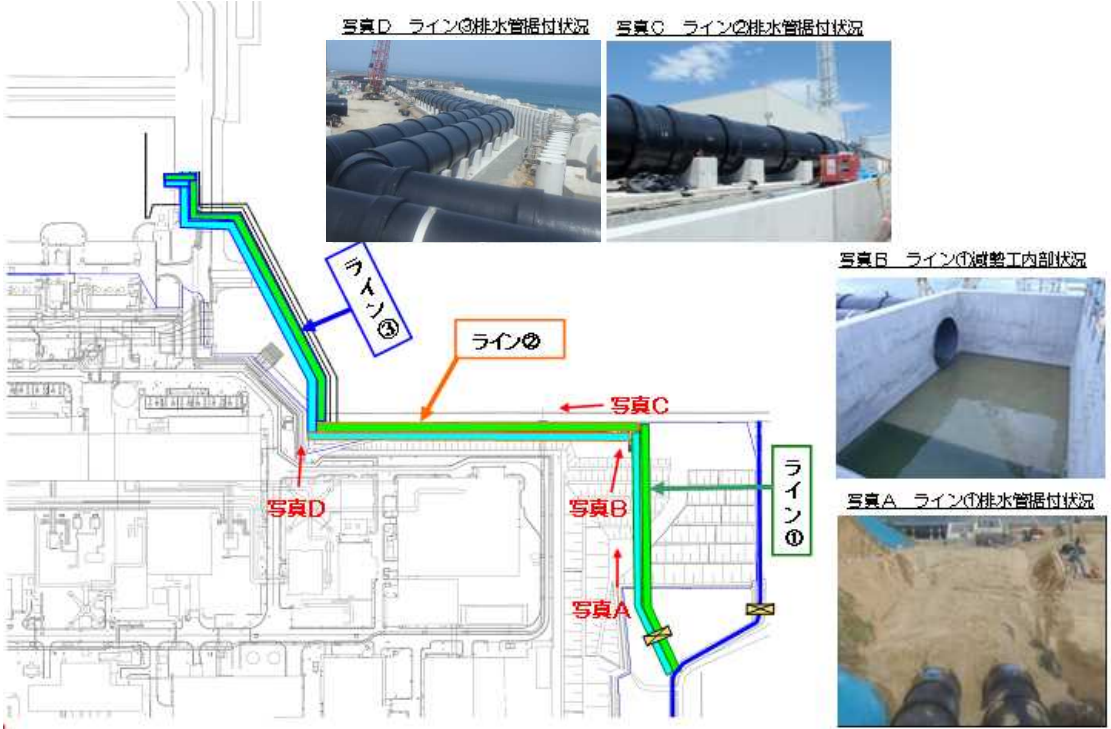


Fig. 10 Status of construction underway