

Situation of Storage and Treatment of Accumulated Water including Highly Concentrated Radioactive Materials at Fukushima Daiichi Nuclear Power Station (255th Release)

June 3, 2016

Tokyo Electric Power Company Holdings, Inc.

1. Introduction

This document is to report the following matters in accordance with the instruction of “Installment of treatment facility and storing facility of water including highly concentrated radioactive materials at Fukushima Daiichi Nuclear Power Station of the Tokyo Electric Power Company (Instruction) “(NISA No. 6, June 8, 2011), dated on June 9, 2011.

<Instruction>

TEPCO should report to NISA the situation of storing and treatment of the contaminated water in the Power Station and the future forecast based upon the current situation has to be reported to NISA as soon as the treatment facility starts its operation. Also, subsequently, continued report has to be submitted to NISA once a week until the treatment of the accumulated water in the Central Radioactive Waste Treatment Facility is completed.

2. Situation of storing and treatment of accumulated water in the building (actual record)

Stored amounts in each unit building (Units 1 to 4 (including condensers and trenches)) and stored and treated amounts, and other related data in the Accumulated Water Storing Facility as of June 2, 2016 are shown in the Attachment -1.

3. Forecast of storing and treatment

(1) Short term forecast

Water transfer is planned so that the levels of the accumulated water in Units 1 and 2 and Units 3 and 4 building will be maintained around at the level of OP. 3,000, based on the stored amount in the Accumulated Water Storing Facilities and the operating situation of the radioactive material treatment equipment. Water is transferred to the Process Main Building and/or High Temperature Incinerator Building as Accumulated Water Storing Facilities.

Treatment is implemented considering the state of storage and transfer of Accumulated Water Storing Facilities.

We assume stored amounts in each unit building (Units 1 to 4 (including condenser and trench)), and stored and treated amounts, and other related data in the Accumulated Water Storing

Facilities as of June 9, 2016, as shown in Attachment -2.

(2) Middle term forecast

Regarding accumulated water in Unit 1 and 2 buildings and Unit 3 and 4 buildings, from the viewpoint of reducing the risks of discharging to the ocean and leaking into the groundwater, it is necessary to keep enough capacity for the accumulated water in the building until its level reaches OP. 4,000 and to keep the accumulated water level lower than the groundwater level. On the other hand, based on the view of limiting inflow of underwater to buildings and reducing the amount of emerged accumulated water, we are planning to transfer accumulated water keeping its level in the building around OP. 3,000 considering water tank capacity.

As for accumulated water of the Process Main Building and the High Temperature Incinerator Building, we are planning to treat the accumulated water considering the situation of construction of middle and low level waste water tanks, the operation factor of the radioactive material treatment instruments and duration for maintenance.

We forecast stored amounts in each unit building (Unit 1 to 4 (including condensers and trenches)), and storing and treatment situations in the Accumulated Water Storing Facilities for the next 3 months, as shown in Attachment -3.

Stored amounts in each building and the water storage equipment are forecasted to be unchanged in case transfer and treatment were implemented as scheduled without rain. However, it would be subject to change depending on the operation factor of the radioactive material treatment instruments and so on.

Also, the water treated at the radioactive material treatment equipment (fresh water and condensed salt water) can be stored in the middle and low level waste water tanks.

END

Storage and treatment of high level radioactive accumulated water (as of June 2, 2016)

Classification	
	High level radioactive water/ Waste, Concentrated waste liquid
	Treated water (saltwater)
	Treated water (concentrated saltwater), pipe removal
	Strontium-treated water
	Treated water (freshwater), pipe removal
	Treated water from Multi-nuclide Removal Facility
	Freshwater

Volume of water to be injected to Reactor (5/26-6/2)	Change from last report
① Filtrate water	-
② Treated water (freshwater)	2,201m ³ / 6m ³
Cumulative treated water	689,583m ³

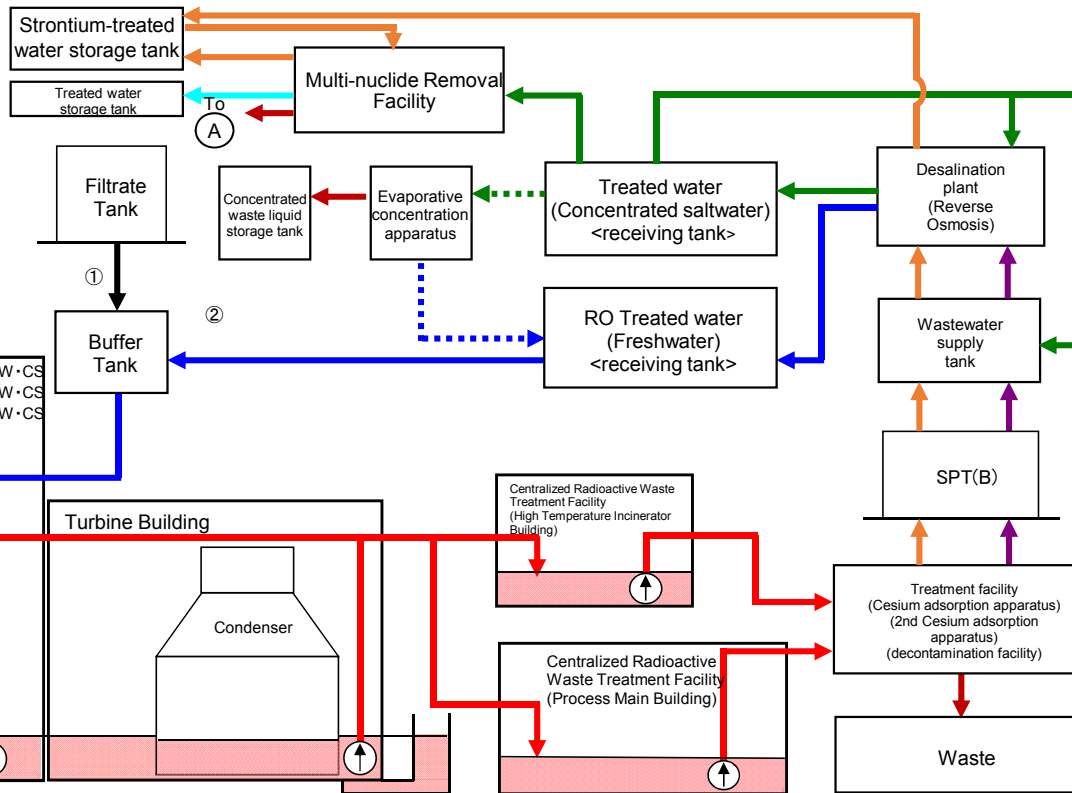
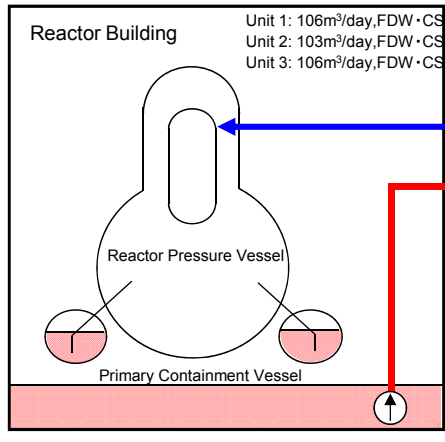

Storage volume*1,2	Change from last report	Storage capacity*3,4
Concentrated saltwater receiving tank*1	0m ³ / -	-
Freshwater receiving tank	16,067m ³ / +618m ³	20,600m ³
Concentrated waste liquid storage tank	9,173m ³ / +3m ³	11,100m ³
Treated water storage tank	647,529m ³ / +3,279m ³	658,600m ³
Strontium-treated water storage tank	180,332m ³ / -826m ³	208,500m ³

Residual water*5	Change from last report	Storage capacity*3,4
Concentrated saltwater receiving	Approx. 4,600m ³ / No Change	Approx. 89,300m ³

Storage volume	Change from last report	Storage volume*3
Wastewater supply tank	718m ³ / +16m ³	1,200m ³
SPT(B)	709m ³ / -319m ³	3,100m ³

Chloride concentration	
Before/After Desalination	240ppm/ <1ppm (Sampled on May 10)
Before/After Evaporative Concentration	-

Place of Sampling	Radioactivity concentration*6
Process Main Building	1.7E+07 Bq/L (Sampled on May 13)
Exit of cesium adsorption apparatus	2.3E+02 Bq/L (Sampled on May 13)
Exit of decontamination facility	-
High Temperature Incinerator Building	1.1E+07 Bq/L (Sampled on May 10)
Exit of second cesium adsorption apparatus	3.7E+03 Bq/L (Sampled on May 10)

Facility	Storage volume	Change from last report	Water level in T/B *8
Unit 1	Approx. 12,100m ³	No Change	T.P.1,214 (O.P.2,671)
Unit 2	Approx. 15,800m ³	+800m ³	T.P.1,418 (O.P.2,870)
Unit 3	Approx. 15,400m ³	-400m ³	T.P.1,275 (O.P.2,712)
Unit 4	Approx. 16,000m ³	-200m ³	T.P.1,403 (O.P.2,842)
Total	Approx. 59,300m ³		

Storage Facility	Storage volume	Change from last report	Water level *8	Treated volume (5/26-6/2)	Cumulative treated volume	Waste produced		Change from last report	Storage capacity
						Sludge	Used vessels		
Process Main Building	Approx. 11,710m ³	+130m ³	T.P.1,530 (O.P. 2,892)	Approx.4,840m ³ *7	Approx. 1,534,080m ³ *7	597m ³	3,179 ⁹	No Change	700m ³ *3
High Temperature Incinerator Building	Approx. 2,780m ³	-610m ³	T.P. 49 (O.P. 1,495)			+6		6,239	
Total	Approx. 14,990m ³								

[Main operations that have been conducted during the period from May 26, 2016 (the previous announcement data) to June 2, 2016]

- Water transfer from the Unit 1 Reactor Building to the High Temperature Incinerator Building was conducted whenever necessary.
- Water transfer from the Unit 2 Turbine Building to High Temperature Incinerator Building was conducted whenever necessary.
- Water transfer from the Unit 3 Turbine Building to the High Temperature Incinerator Building was conducted whenever necessary.
- On May 29, water transfer from the Unit 1 Turbine Building and the Unit 1 Radioactive Waste Treatment Facility was conducted.
- From May 18, the operation of the Cesium Adsorption Apparatus has been suspended.
- The operation of the 2nd Cesium Adsorption Apparatus has been conducted; the availability factor has been 58% (previously assumed: 60%)
- On May 28 and June 1, water transfer from the duct connecting between the Radioactive Waste Treatment Facilities to the Unit 4 Turbine Building was conducted.
- Storage capacity of treated water increased by starting the operations of new storage tanks.

*1 The figures of the data are treated as a reference, because water levels during water transfer are not stable.
 *2 The figures of the storage volumes do not include those of the following volumes that have accumulated from the bottom of the tanks to the height of so-called "down scale (DS)," where water gauges show 0%:
 Freshwater receiving tank (approx. 1,000m³), Concentrated waste liquid storage tank (approx. 100m³),
 Treated water storage tank (approx. 1,000m³), Strontium-treated water storage tank (approx. 3,000m³).
 *3 The figures of the data show the operational limits.
 *4 The figures of "Storage capacity" do not include those of the volumes that have accumulated from the bottom of the tanks to the height of so-called "down scale (DS)," where water gauges show 0%. However, each tank has the capacity that accommodates more than the storage volume that accumulates up to the height of "DS."
 *5 The figure of "Residual water" includes the one of the volumes that have accumulated from the bottom of the tanks to the height of so-called "down scale (DS)," where water gauges show 0%. The amount of the residual water of concentrated saltwater is calculated based on that of the water treated through the ALPS and other facilities.
 *6 The data shown here are those of Cs-137.
 *7 Total treated amount of Cesium adsorption apparatus and 2nd Cesium adsorption apparatus
 Breakdown of the treated amount: Cesium adsorption apparatus (0m³)
 2nd Cesium adsorption apparatus (4,840m³)
 Breakdown of the cumulative treated amount: Cesium adsorption apparatus (346,580m³)
 2nd Cesium adsorption apparatus (1,187,500m³)
 *8 The data of the water levels in the Reactor Buildings are the data as of 7 a.m., June 2.
 *9 Breakdown of the used vessels: Cesium adsorption apparatus (734)
 2nd Cesium adsorption apparatus (164)
 Others: Storage container (2,018), Treated column (9), Used vessel (189), Filters and so forth (65)

Storage and treatment of high level radioactive accumulated water (as of June 9, 2016)

Classification	
	High level radioactive water/Waste, Concentrated waste hold
	Treated water (saltwater)
	Treated water (concentrated saltwater) / Removal of piping
	Strontium-treated water
	Treated water (freshwater) / Removal of piping
	Treated water from Multi-nuclide Removal Equipment
	Freshwater

Volume of water to be injected to Reactor (6/2-6/9)	Change from last report
① Filtrate water	-
② Treated water (freshwater)	+67m ³
Cumulative treated water	691,851m ³

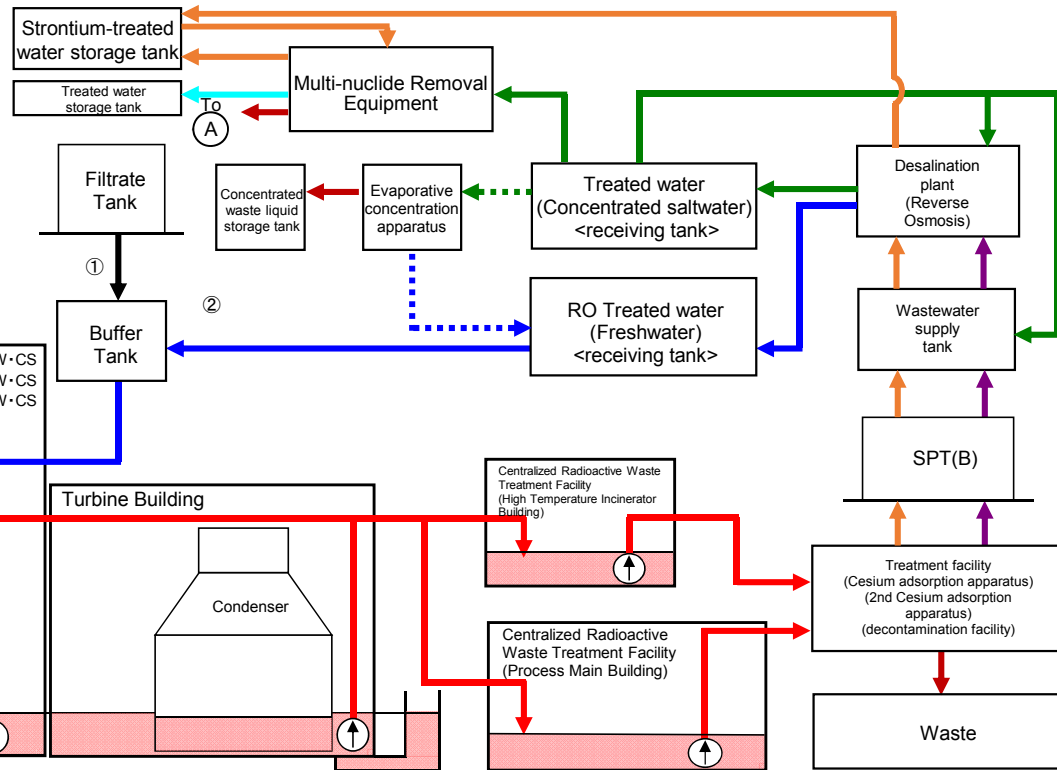

Storage volume*1	Change from last report	Storage capacity*2,3
Concentrated saltwater receiving tank*1	0m ³	-
Freshwater receiving tank	15,815m ³	-252m ³
Concentrated waste liquid storage tank	9,173m ³	No Change
Treated water storage tank*4	651,198m ³	+3,669m ³
Strontium-treated water storage tank	180,021m ³	-311m ³

Residual water*4	Change from last report	Storage capacity*2,3
Concentrated saltwater receiving tank	Approx. 4,600m ³	No Change
		Approx. 89,300m ³

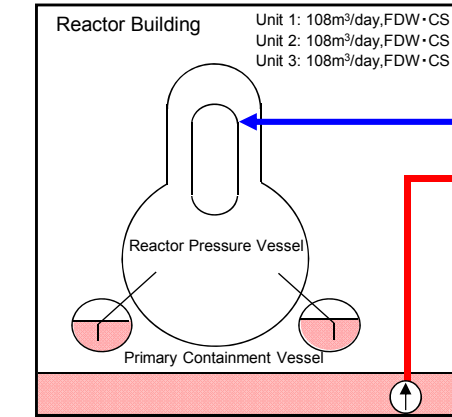

Facility	Storage volume	Change from last report	Water level in T/B *8
Unit 1	Approx. 12,100m ³	No Change	T.P. 1,468 (O.P. 2,920) (Unit 2 T/B)
Unit 2	Approx. 16,200m ³	+400m ³	
Unit 3	Approx. 15,500m ³	+100m ³	T.P. 1,288 (O.P. 2,725) (Unit 3 T/B)
Unit 4	Approx. 16,100m ³	+100m ³	
Total	Approx. 59,900m ³		

Storage Facility	Storage volume	Change from last report	Water level	Treated volume (6/2-6/9)	Cumulative treated volume	Waste produced		Change from last report	Storage capacity
						Sludge	Used vessels		
Process Main Building	Approx. 11,860m ³	+150m ³	T.P. 1,571 (O.P. 2,933)	Approx. 5,040m ³ *5	Approx. 1,539,120m ³ *5	Sludge	597m ³	No Change	700m ³ *2
High Temperature Incinerator Building	Approx. 2,700m ³	-80m ³	T.P. -13 (O.P. 1,433)			Used vessels	3,187*6		
Total	Approx. 14,560m ³								

[Main operations that are planned to be conducted during the period from June 2, 2016 to June 9, 2016.]

- Water transfer from the Unit 1 Reactor Building to the High Temperature Incinerator Building will be conducted whenever necessary.
- Water transfer from the Unit 2 Turbine Building to the High Temperature Incinerator Building will be conducted whenever necessary.
- Water transfer from the Unit 3 Turbine Building to the High Temperature Incinerator Building will be conducted whenever necessary.
- Water transfer from the Unit 1 Turbine Building and the Unit 1 Radioactive Waste Treatment Facility will be conducted whenever necessary.
- The operation of the Cesium Adsorption Apparatus is scheduled to be suspended.
- The operation of the 2nd Cesium Adsorption Apparatus is scheduled to be conducted (assumed availability factor 60%).

*1 The figures of "Storage volume" do not include those of the volumes that have accumulated from the bottom of the tanks to the height of so-called "down scale (DS)," where water gauges show 0%.

*2 The figures of the data show the operational limits.

*3 The figures of "Storage capacity" do not include those of the volumes that have accumulated from the bottom of the tanks to the height of so-called "down scale (DS)," where water gauges show 0%. However, each tank has the capacity that accommodates more than the storage volume that accumulates up to the height of "DS."

*4 The figure of "Residual water" includes the one of the volumes that have accumulated from the bottom of the tanks to the height of so-called "down scale (DS)," where water gauges show 0%. The amount of the residual water of concentrated saltwater is calculated based on that of the water treated through the ALPS and other facilities.

*5 Total treated amount of Cesium adsorption apparatus and 2nd Cesium adsorption apparatus

Breakdown of the treated amount: Cesium adsorption apparatus (0m³)

2nd Cesium adsorption apparatus (5,040m³)

Breakdown of the cumulative treated amount: Cesium adsorption apparatus (346,580m³)

2nd Cesium adsorption apparatus (1,192,540m³)

*6 Breakdown of the used vessels: Cesium adsorption apparatus (734)

2nd Cesium adsorption apparatus (164)

Others: Storage container (2,026), Treated column (9), Used vessels (189), Filters and so forth (65)

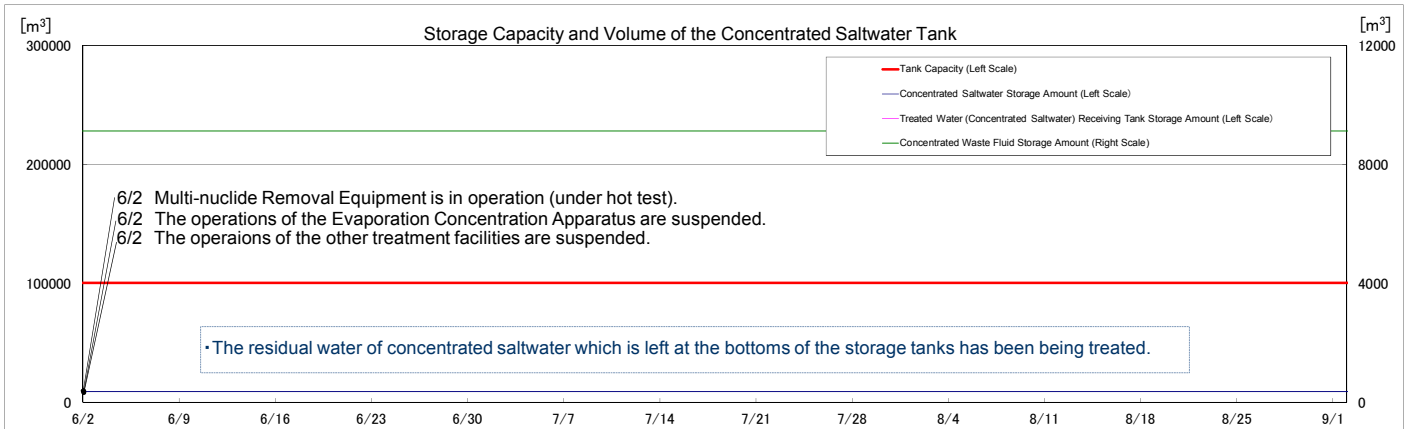
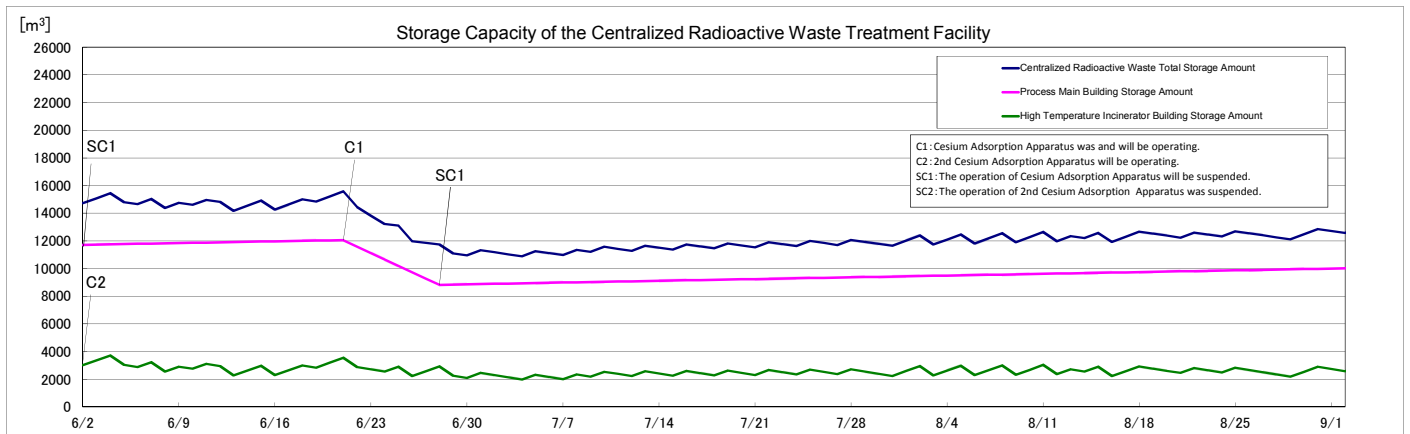
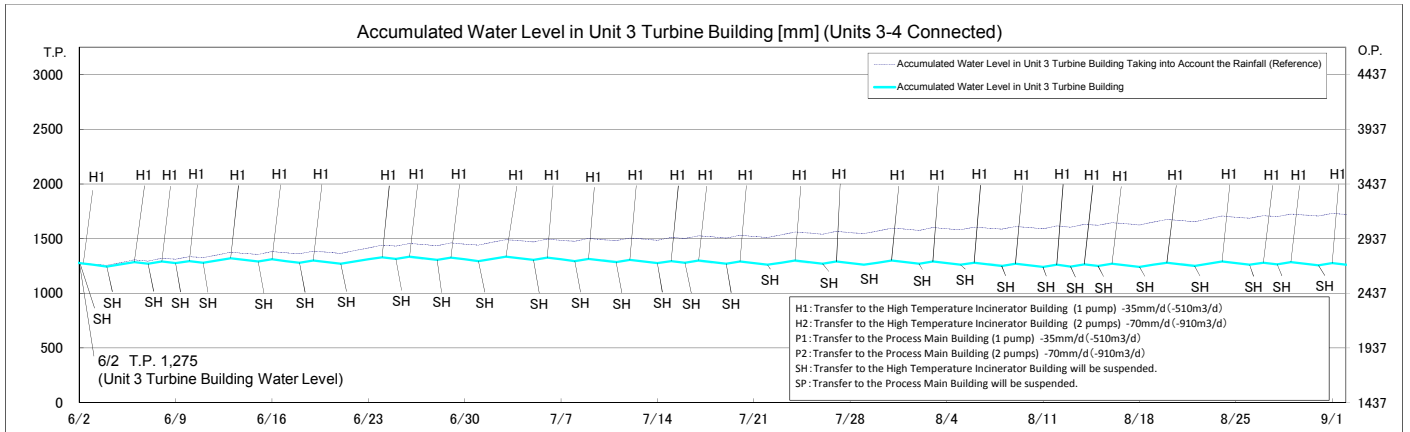
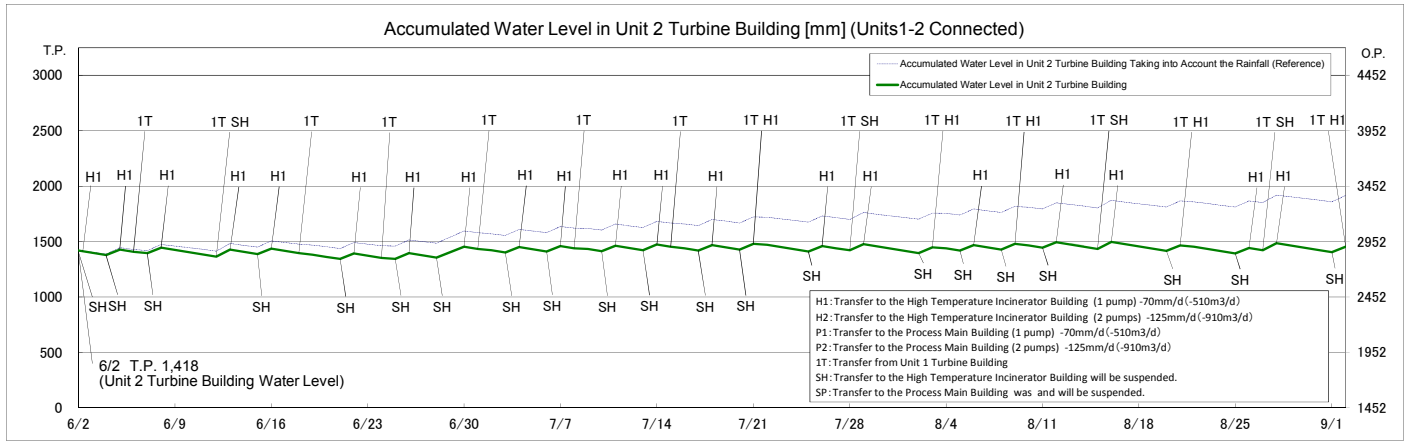

Note

- The amount of water treated through the 2nd Cesium Adsorption Apparatus is estimated to be 780m³/d (Subject to change depending on the factors such as the levels of water accumulated in T/Bs.)
- "Accumulated Water Levels in Unit 2 and 3 T/Bs" are simulated water levels in consideration of the change of the water levels caused by recent rainfall, inflow of groundwater, etc. in the surrounding areas of the Fukushima Daiichi Nuclear Power Station.
- "Accumulated Water Levels in Unit 2 and 3 T/Bs Taking into Account the Rainfall" are simulated water levels which are calculated by adding to the accumulated water amounts which are assumed to increase at the rate of 5mm a day when the surrounding areas of the Fukushima Daiichi Nuclear Power Station have the rainfall equal to the average amount of rain which fell for three months from August to October in 2008 to 2010.